



DataSys 2019

Panel on Telecommunications

Topic: Emerging Trends in the Telecommunications for the Next Decade

DataSys 2019, July 28 - August 2, Nice



Emerging Trends in the Telecommunications for the Next Decade

Moderator

Eugen Borcoci, University Politehnica Bucharest, Romania

Panelists

Abheek Saha, Hughes Systique Corporation, India

Maciej Sobieraj, Poznan University of Technology, Poland

Višnja Križanović, Faculty of Electrical Engineering, Computer Science and Information Technology Osijek, Croatia

Eugen Borcoci, University Politehnica Bucharest, Romania



Emerging Trends in the Telecommunications for the Next Decade

Specific topics

Abheek Saha: Emerging architectures for next generation communication networks, including edge and mobile cloud architectures, cloud RAN and virtual RAN and collaborative radio networking

Maciej Sobieraj: Structures of switching networks, structures of connections in Data Centers versus energy saving

Višnja Križanović: The value of collaborative vs. competitive strategies in future development of advanced ICT solutions

Eugen Borcoci: Cooperation of SDN and NFV technologies in 5G management and control



Emerging Trends in the Telecommunications for the Next Decade

Panelists:

Abheek Saha:

- work in RAN development and testing for 4G and 5G systems -25 years in the industry
- design and development of different RANs including cellular, satellite and ground-to-air aviation systems
- co-author for the ETSI GMR-1 std. for personal comm. systems over satellite
- interests in resource management, capacity modeling and RAN architectures

Maciej Sobieraj:

- M.Sc. and Ph.D. in Electronics and Telecommunications, Poznan University of Technology, Poland
- Chair of Communication and Computer Networks at the Faculty of Electronics and Telecommunications at Poznan University of Technology
- research in the area of modeling multiservice cellular systems and electronic and optical switching networks, traffic engineering in TCP/IP networks

DataSys 2019, July 28 - August 2, Nice



Emerging Trends in the Telecommunications for the Next Decade

Panelists:

Višnja Križanović:

- Asst. Professor Chair of Radiocommunication and Telecomm. Department of Communications Faculty of Electrical Engineering, Computer Science and Information Technology Osijek, Josip Juraj Strossmayer University in Osijek, Croatia
- teaching: - courses on undergraduate and graduate level of ICT studies in electrical engineering
- TPC member of several int'l conf. (IARIA AICT, IEEE SST PhD Forum, IEEE ConTEL PhD Forum, ESSCA Symposium and WoSC Int'l Workshop)
- Int'l (Erasmus+) and national research projects - ICT solutions' implementation and optimisation

Eugen Borcoci:

- professor at Univ. Politehnica Bucharest, Romania, Electronics, Telecomm. and Information Technology Faculty, Telecomm. Dept.
- teaching and research in specific domains of telecomm. and computer networks architectures, technologies and services
- participation at many research projects and TPC member at int'l conferences
- recent interest: SDN, NFV, Cloud/fog/edge computing, 4G/5G networking and slicing, vehicular communications

DataSys 2019, July 28 - August 2, Nice



Emerging Trends in the Telecommunications for the Next Decade

Telecommunications trends ?

- Dynamics of telecom services - past period

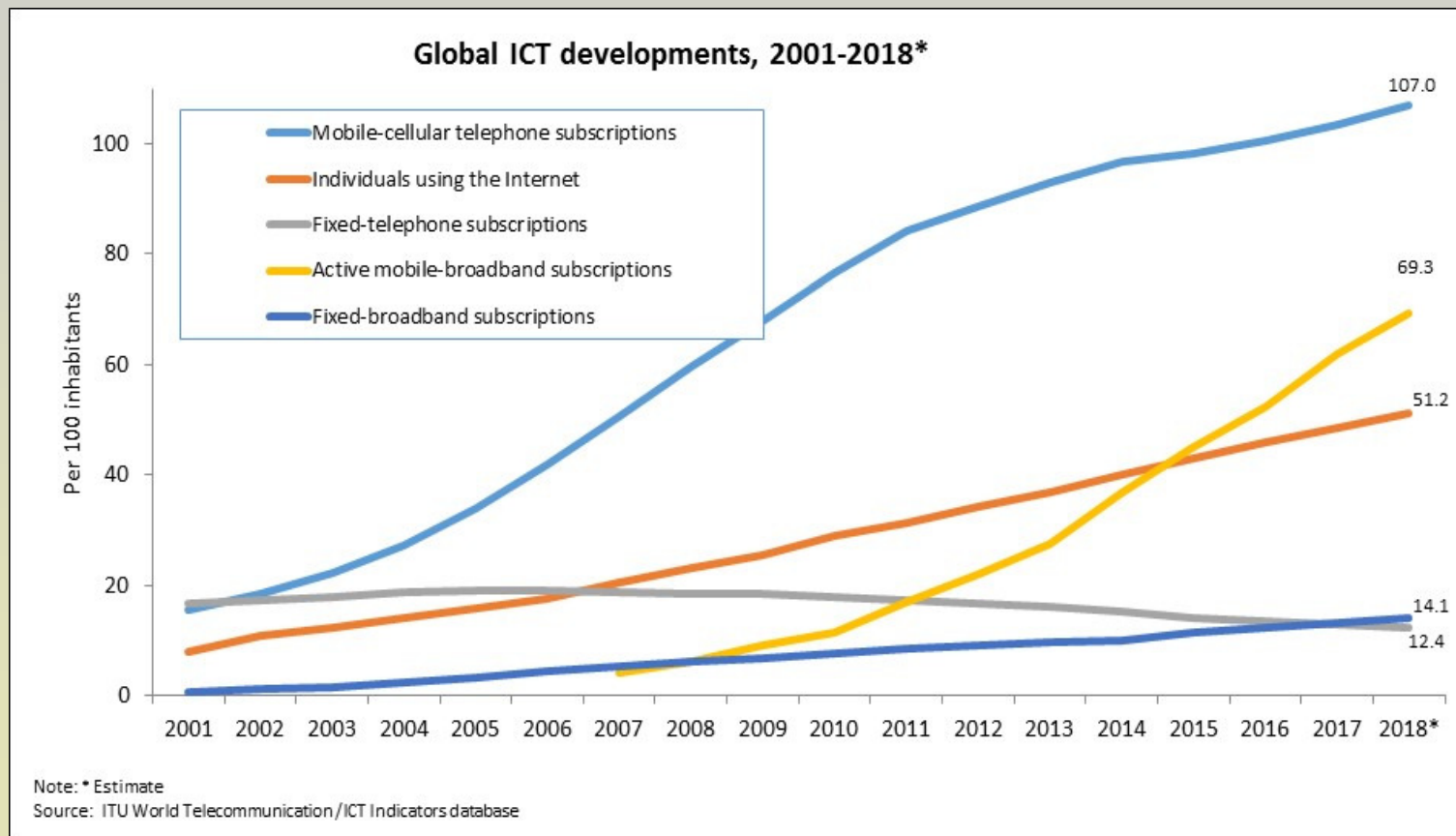

DataSys 2019, July 28 - August 2, Nice



Emerging Trends in the Telecommunications for the Next Decade

Telecommunications trends ?

- Increasing Telco integration with IT technologies and services



https://www.ey.com/en_gl/tmt/digital-transformation-for-2020-and-beyond-eight-telco-considera

DataSys 2019, July 28 - August 2, Nice



Emerging Trends in the Telecommunications for the Next Decade

Telecommunications trends ?

- Increasing Telco integration with IT technologies and services

Source: ESPAS: CHALLENGES AND CHOICES *FOR EUROPE*, 2019
https://ec.europa.eu/epsc/sites/epsc/files/espas_report2019.pdf

Technology tipping points

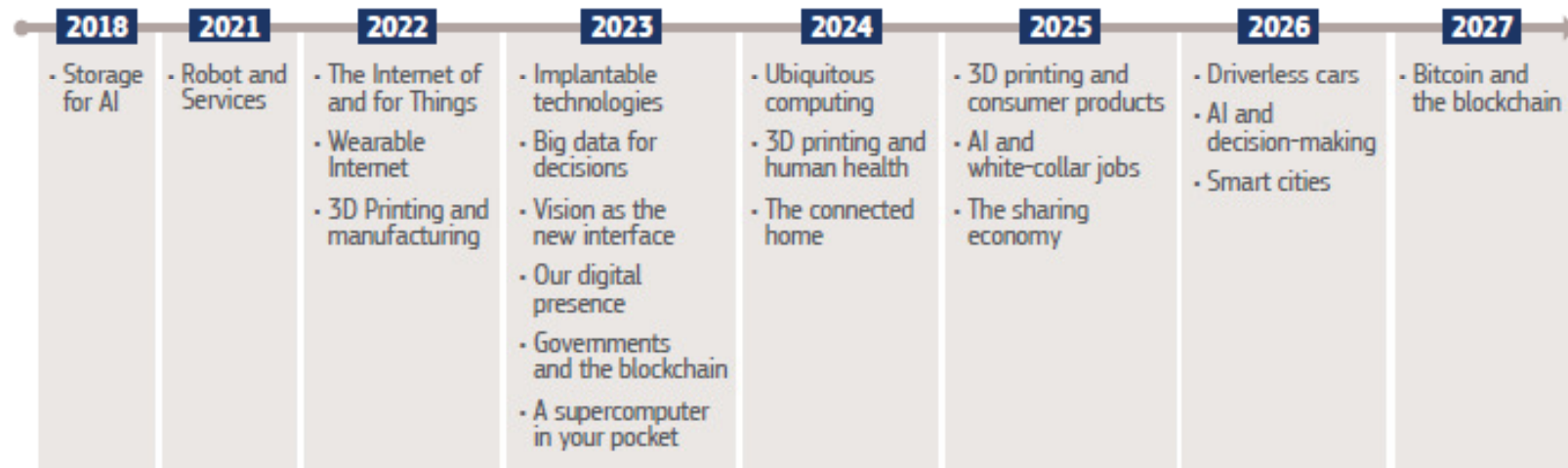

Note: Average year in which each tipping point is expected to occur according to a survey conducted to more than 800 ICT executives and experts

Source: World Economic Forum, 2015



Emerging Trends in the Telecommunications for the Next Decade

Telecommunications trends ?

- Increasing Telco integration with IT technologies and services
- Specific technologies and services
 - Internet of Things- lot of applications
 - Bandwidth on demand, mobility, real-time: 5G, 6G, ..
 - Example: 5G
 - Massive machine type communication (mMTC)
 - Ultra reliability low latency communication (URLLC)
 - Enhanced mobile broadband (eMBB)
 - Softwarization: SDN, NFV, ..
 - Cloud/fog/edge computing – integrated with telecom networks
 - Artificial intelligence : machine learning,
 - Privacy and security issues
 -



Emerging Trends in the Telecommunications for the Next Decade

PANELISTS....



Future Trends in Wireless Technology (Group Disc. – AICT 2019)

Trends in future Wireless architectures



- The Radio Access Network is still the most expensive part of the modern radio network
 - 90% of the capex cost of setting up a network
 - One of the top five consumers of energy
- Exponential gains in efficiency
 - GSM: 2.4 calls/Mhz/sq.km
 - 3G: 8-9 calls/Mhz/sq.km
 - 4G: ~100 calls/Mhz/sq.km
 - 5G: should achieve in the 1000s (1 million devices per sq.km)
- Digital base-band processing is the most complex part of the system
 - >60% of the cost of the system
 - >50% energy usage.

Parallels to the IT industry

- The advent of the cloud and virtualized systems
 - Enables operational efficiency
 - Fosters new mode of application development and deployment
 - Keystone was the first generation of “cloud” platforms for RAN
- Borrowing ‘dense, programmable’ networks from the world of Networking
 - Re-organization of the cellular network from isolated cells to cooperating clusters
 - Joint optimization for coverage-capacity tradeoff

Advances in RAN technology

- Real-time cooperative networking
 - Coordinated MultiPoint, Interference Coordination, etc.
- RAN in the cloud
 - First gen:
 - Combined ARM/x86+DSP boards (TI Keystone series)
 - Second gen:
 - Vectorized instructions in standard CPU enable entire base-band to be developed on commodity hardware
 - AVX2, AVX512
 - The possibility of building 'data-center' RANs with savings in utilization of digital equipment, power conservation, auto-scaling, etc.
- Programmable network
 - Control and data plane separability



DataSys 2019

Panel on Telecommunications

Topic: Emerging Trends in the Telecommunications for the Next Decade

Cooperation of SDN and NFV technologies in
5G management and control

Eugen Borcoci

University POLITEHNICA of Bucharest, Romania

Eugen.Borcoci@elcom.pub.ro



Cooperation of SDN and NFV technologies in 5G management and control



- The 5G (fifth generation): **new generation of mobile networks** offering a large range of services to satisfy various customer demands
- Different from 4G concept: “one-fit-all”, 5G supports
 - **dedicated, separated - logical slices** – on top of a shared infrastructure
 - **customization for various business demands with different requirements**
- **Driving forces for 5G**: IoT, smart cities, industry, governance, IoV/automotive, safety/emergency, entertainment, environment, etc. → **multiple types of “verticals” and tenants**
- Many **Standardization/forums organizations** and projects involved
 - NGNM, 3GPP, 5GPPP, ETSI, ITU-T, GSMA, BBF, ONF, IETF, IEEE, many int’l and European projects



Cooperation of SDN and NFV technologies in 5G management and control



- **Three views/sets-of-requirements for 5G**
 - *user-centric, service-provider-centric, network-operator-centric*
- **5G Key technological characteristics**
 - Integrates different and heterogeneous access technologies, cellular, **Radio Access Technologies (RAT)**, satellite, ..
 - Ultra-dense networks with numerous small cells
 - **Driven by SW**
 - unified OS in a number of PoPs, especially at the network edge
 - **Complementary technologies**
 - **Software Defined Networking (SDN)**
 - **Network Functions Virtualization (NFV)**
 - **Cloud/Mobile Edge Computing (MEC) /Fog Computing (FC)**
- **5G Network slicing –multi-tenant, multi-domain, E2E, multi-provider/operator context** → many open research issues and challenges, especially in management and control (MC)subsystems
- **SN + NFV – powerful tools to construct M&C subsystems**

- SDN – NFV are complementary (orthogonal)
 - SDN functional blocks (controllers, switches) can be implemented as VNFs
 - PNF/VNFs connectivity (chaining in graphs) can be controlled in SDN style

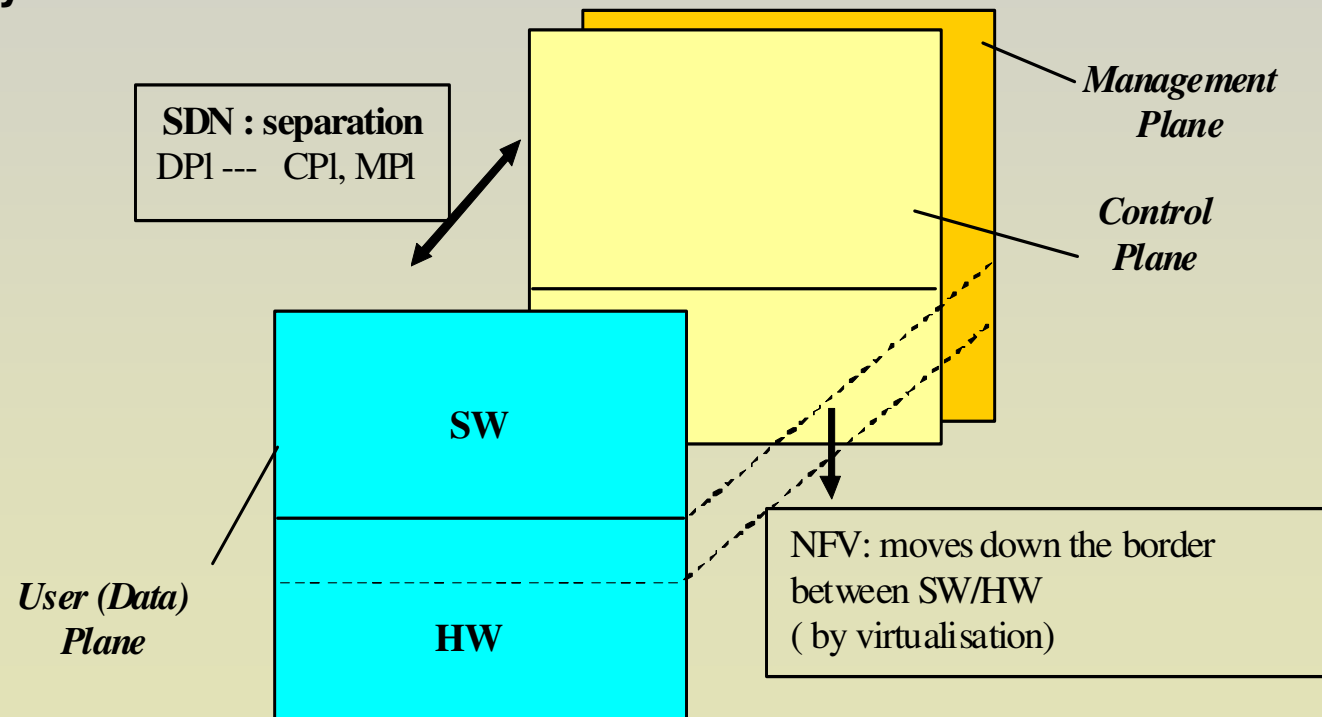



Cooperation of SDN and NFV technologies in 5G management and control



- **Three views/sets-of-requirements for 5G**
 - *user-centric, service-provider-centric, network-operator-centric*
- **5G Key technological characteristics**
 - Integrates different and heterogeneous access technologies, cellular, **Radio Access Technologies (RAT)**, satellite, ..
 - Ultra-dense networks with numerous small cells
 - **Driven by SW**
 - unified OS in a number of PoPs, especially at the network edge
 - **Complementary technologies**
 - **Software Defined Networking (SDN)**
 - **Network Functions Virtualization (NFV)**
 - **Cloud/Mobile Edge Computing (MEC) /Fog Computing (FC)**
- **5G Network slicing –multi-tenant, multi-domain, E2E, multi-provider/operator context** → many open research issues and challenges, especially in management and control (MC)subsystems
- **SN + NFV – powerful tools to construct M&C subsystems**



Cooperation of SDN and NFV technologies in 5G management and control



Example: Multi-tenant – multi-domain architecture – ETSI (run-time view)

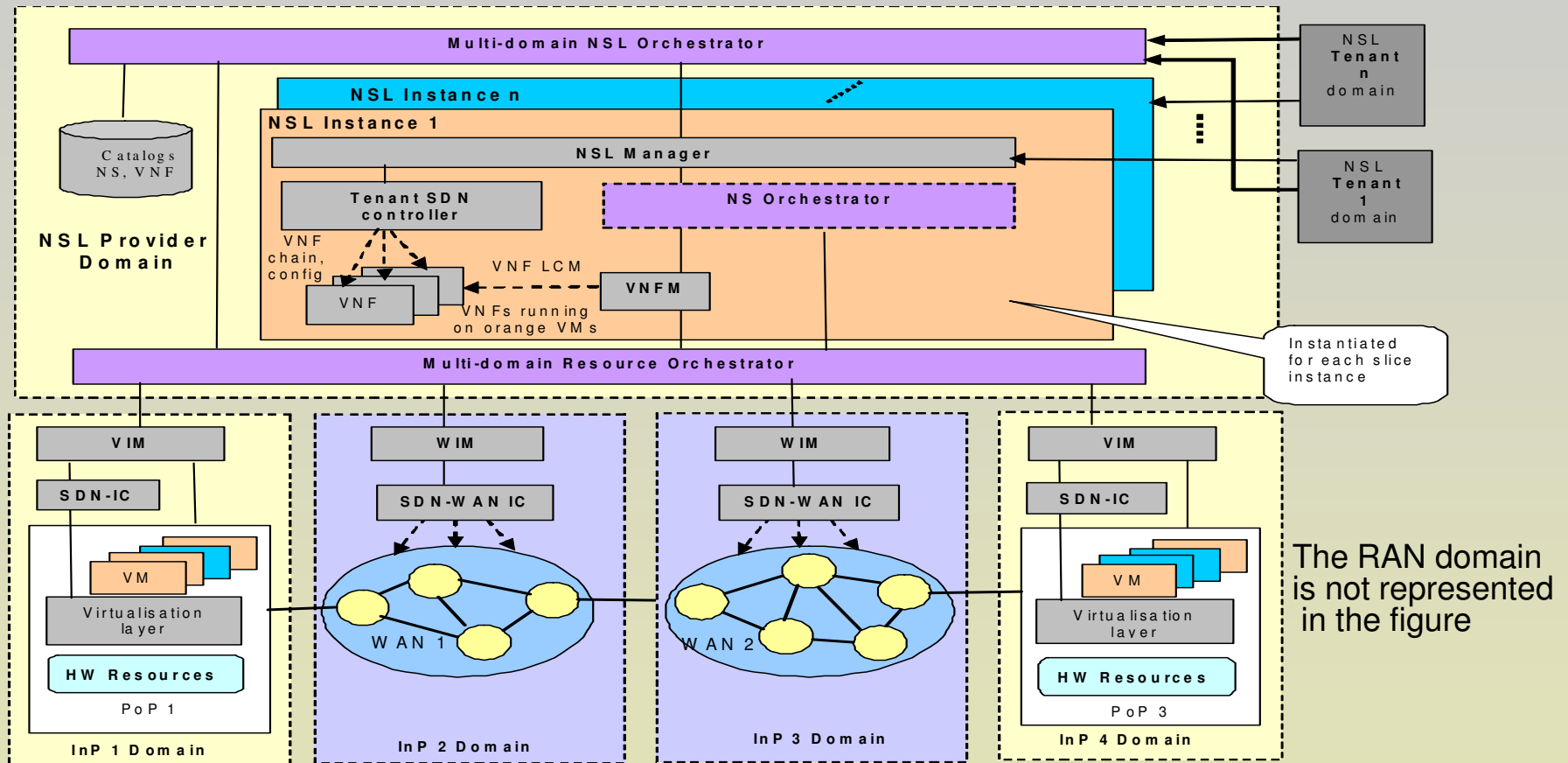

Adapted from source: J.Ordonez-Lucena, et.al., "The Creation Phase in Network Slicing: From a Service Order to an Operative Network Slice", European Conf. on Networks and Comm. (EuCNC), 2018, <https://arxiv.org/abs/1804.09642>
 ETSI GR NFV-EVE 012 V3.1.1 (2017-12), Release 3 "NFV Evolution and Ecosystem; Report on Network Slicing Support with ETSI NFV Architecture Framework".



Cooperation of SDN and NFV technologies in 5G management and control



▪ Conclusions

- cooperating SDN and NFV technologies –powerful and flexible solution for management and control in 5G slicing
- Open research issues in M&C – based on NFV/SDN (examples)
 - Hierarchical/Flat organization of the M&C sub-system
 - Initial SDN controllers placement (in a multi-domain context)
 - Initial VNF placement (in a multi-domain context)
 - SDN blocks (controllers, switches) and VNFs migration during slices run-time – optimization problem (NP complete)
 - Resource (computing, storage, connectivity) management in multi-domain contexts
 -



Maciej Sobieraj

Structures of switching networks, structures of connections in Data Centers versus energy saving



Switching network as connection scheme in Data Centers

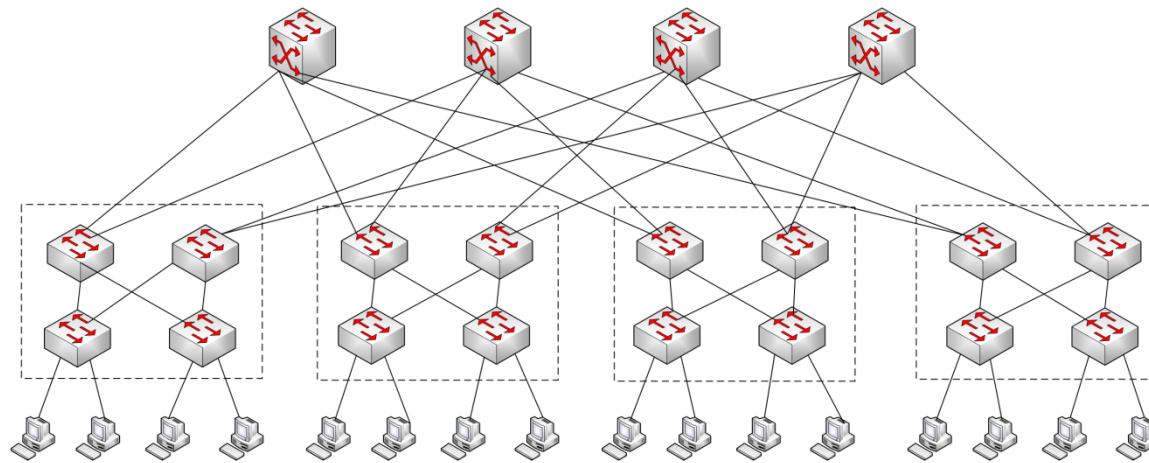

Switching network (switching fabric) is a combination of hardware and software that controls traffic to and from a network node with the use of multiple switches

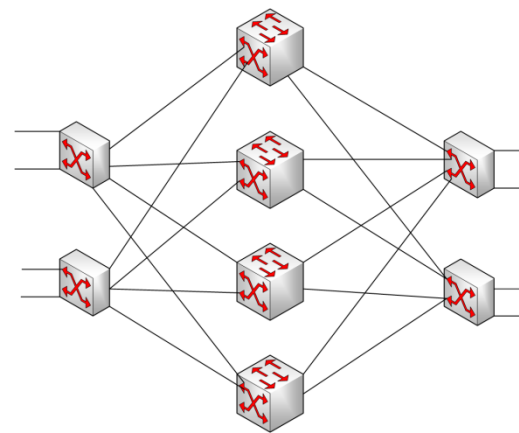

Switching network as interconnection scheme in routers

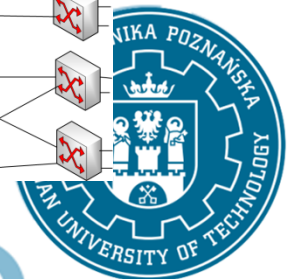
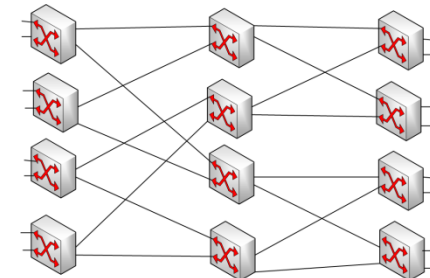
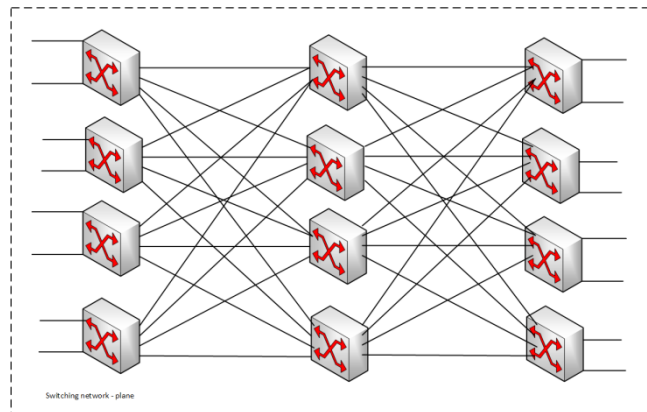
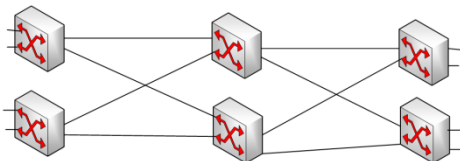
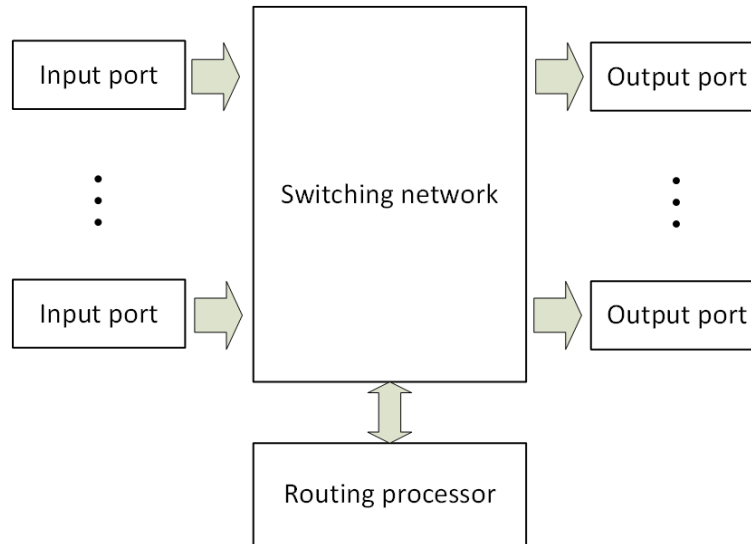

Energy saving strategy

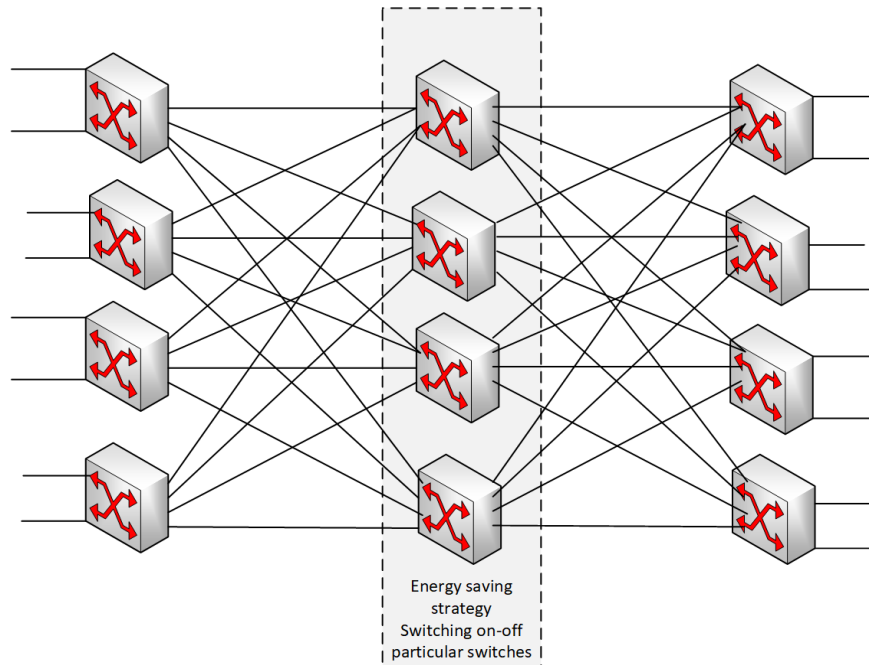

In the case of low network load it is possible to disable the switches of the middle section.

Cisco CRS router – maximum power consumption 19.56 kW
Cisco 6500 series switch – maximum power consumption – 8.7 kW

Source: cisco.com

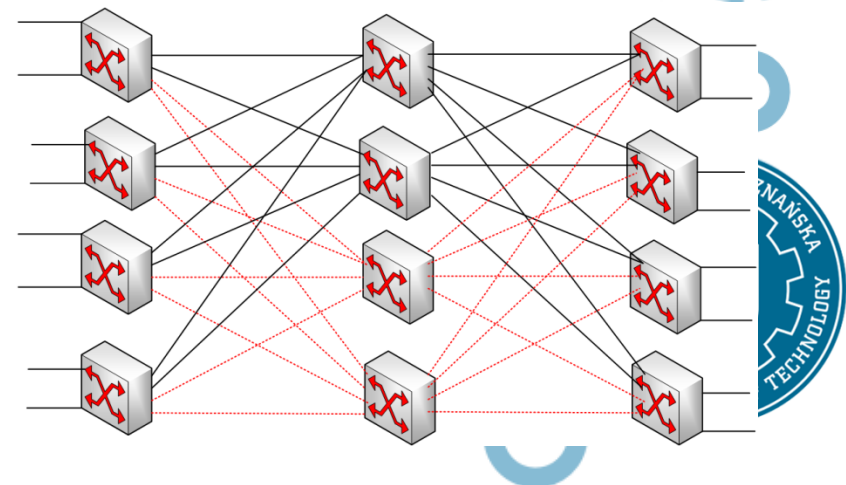

Some calculations

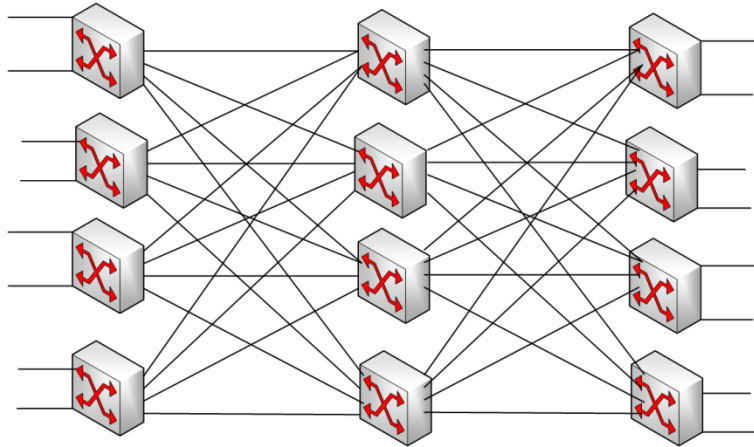

$$n [P_n]_{vf} = \sum_{c=0}^{M_C} A_c t_c \sigma_{\text{str},c}(n - t_c) [P_{n-t_c}]_{vf}$$

$$E_{\text{Ex},c} = \sum_{n=0}^{vf} [P_n]_{vf} [1 - \sigma_{\text{str},c}(n)]$$

$$E_{\text{In},c} = \sum_{s=1}^{v-d_{z,c}} \frac{P(c, s)}{1 - P(c, 0)} \left[\binom{v-s}{d_{z,c}} / \binom{v}{d_{z,c}} \right]$$

It is possible to predict blocking probability or serviced traffic in the case when we switch off some switches in the middle stage



The value of collaborative strategies in future development of advanced ICT solutions

Technology and the future of work:

➤ In response to fast **digitalisation and globalisation** trends, **the world of work** is rapidly **changing**. While certain jobs are disappearing, others are emerging. Over the last two decades, a share of **highly-skilled jobs** has increased by 25%; moreover, the emerging **automation processes** have a tendency to completely change almost 15% of jobs, and to significantly change over 30% of jobs. *(Source: OECD Employment Outlook 2019: The Future of Work)*

Technological, socio-economic and geo-demographic factors that induce changes:

➤ In the next few years, the **key ICT technologies** which have already started inducing innovation: **mobile, cloud computing, big data analytics, social business, and IoT**; will combine with other emerging solutions which include: **crowdsourcing, virtual/augmented reality, wearables, advanced manufacturing and 3D printing, cognitive systems, advanced robotics and autonomous transport**, as well as **artificial intelligence and machine learning**. The key ICT technologies, in combination with the following **key enabling technologies: nanotechnologies, micro and nano electronics, advanced materials, industrial biotechnology, photonics, and advanced manufacturing technologies**, can generate new ICT business models and impact industry. *(Source: High-Tech Leadership Skills for Europe - Towards an Agenda for 2020 and beyond, Final Report, EC, 2017.)*

➤ Also, additional important factors that induce changes include: **regional differences in techno-economic development and availability of jobs, rapid urbanization trends, changes in population demographics (e.g., ageing), climate change, and natural resource constraints**.

The main research and development challenges within ICT domain:

➤ **Challenge: THE EMERGENCE OF A DIVERSE RANGE OF NEW PARTICIPANTS, TECHNOLOGIES AND DEVICES ON ICT MARKETS; Requirements:** Development of a complete connectivity-enabled ICT ecosystems that support new market participants to enter markets and create innovative ICT business solutions.

➤ **Challenge: AN INCREASED COMPLEXITY OF EMERGING HETEROGENEOUS ICT SYSTEMS; Requirements:** Development of tools for interoperable, adaptive, secure and trustworthy software, and development of self-managed systems and software-defined architectures to deal with heterogeneous environments.

➤ **Challenge: AN INCREASING VOLUMES OF DIVERSE DIGITAL DATA FROM DISTRIBUTED SOURCES; Requirements:** Development of novel methods and approaches for gathering information from distributed sources, machine learning, analytics and big data management, in coordination with adequate technology areas: artificial intelligence, big data analytics, software engineering, cloud technologies, IoT, edge, fog, and ubiquitous computing.

➤ **Challenge: THE DEVELOPMENT OF A HUMAN-CENTRIC INTERNET; Requirements:** Development of new accountable models to increase trustworthiness of the information exchange on the networks, and providing solutions for transparent transactions over networks.

➤ **Challenge: THE SETTINGS FOR SMART AND SELF-RECONFIGURABLE NEXT GENERATION IoT ENVIRONMENTS; Requirements:** Development of next generation architectures with a focus on user-aware, self-aware and semi-autonomous IoT systems, connecting vast numbers of heterogeneous sensing devices and services with capabilities such as integration with parallel, opportunistic and contextual computing.

- *The common metrics for optimisation and efficiency: time, bandwidth, energy consumption, level of quality, level of security...*

Collaboration in addressing shared challenges and sustainability achievement:

➤ In addressing **shared issues** within the health, food, energy, transport, climate, or inclusive societies domains, given the great complexity of their causes, **different disciplines** (e.g., **technology and socio-economic science**) should be **complementingly involved** in creating **frameworks, methodologies, and tools** that can be applied widely to effectively equalize **the conditions for sustainability** (e.g., for **environmental sustainability** which includes **regenerative agriculture, water management**, etc.). Addressing these issues requires a **collective response** and **collaboration among complementary educational institutions**, and **industry-education partnerships**, since **combining knowledge, resources and capabilities** has advantages in faster **creating of more effective and harmonized solutions**.