



USN University of
South-Eastern Norway

Smart Cities and the Internet of Things: Opportunities and Challenges (Keynote Presentation)

Lasse Berntzen

Professor, School of Business
University of South-Eastern Norway

About me

- Professor, Information Systems
- University of South-Eastern Norway, 18.000 students in eight campuses located south and west of Oslo (the capital).
- Teaches modules on Internet of Things (IoT) and mining social data.
- Research group on Smart Cities.

Agenda

- Smart Cities
- Data and Information
- Internet of Things (IoT)
- Sensors as Data Providers
- Two Smart City / Internet of Things Projects
- Opportunities and Challenges

Smart Cities

- Smart city is a concept
- Most definitions includes the use of computer technology
- Main objective is to improve quality of life for its citizens
 - Provide better services
 - Reduce environmental footprint, sustainability
 - Facilitate participation

What is a Smart City?

Smart cities are places where information technology is combined with infrastructure, architecture, everyday objects, and even our bodies to address **social**, **economic**, and **environmental** problems.

Anthony B. Townsend. (2014) Smart Cities, W.W.Norton & Company

Smart Cities

- Can be seen as an umbrella for research on public service delivery, environmental awareness and good governance.
- The most common approach is to choose an application area, and develop a new product, service or process to deal with some specific problem, or to study an existing product, service or process.
- Another approach is to study the smart city as a large, complex system.



Smart Cities

Some application areas:

- Communication
- Culture
- Education
- Energy
- Emergency services
- Environment/climate
- Health
- Safety and security
- Tourism
- Transport
- Utilities
- Work

Example: Transport

- Use data to make better traffic flow
- Examples:
 - Where is traffic jams, alternative routes?
 - Use traffic data to control traffic lights
 - Where to find an available parking spot?
 - Avoid driving around to find a free one
- Real time information on public transport
- Autonomous vehicles – self driving buses and cars



Example: Environment

- Monitor environmental conditions
- When to enforce traffic restrictions (control pollution levels)
- Better public transport solutions (to reduce car use)
- Smart street lights (to conserve energy)
- Teleworking (to reduce car use)
- Using renewable energy

Intelligent and LED Street Lights



LED – more light for less energy
Intelligent – turn on only when necessary



Example: Safety and Security

- Improved emergency response services
- Surveillance cameras, sound detection
- Send messages or do automated phone calls to alert citizens of emergencies.
- Use data for crime prevention

Smart Cities, Big Data and Smart Decision-making

Understanding “Big Data” in Smart City Applications

Lasse Berntzen, Marius Rohde Johannessen, Rania El-Gazzar



“Big Data” Sources

- Social Data
 - From WEB 2.0 applications like social networks (Facebook, LinkedIn, Twitter, Blogs, Flickr).
- Open Data
 - Repositories of data sets accessible for everyone.
 - Open government initiatives
- Sensor data
 - Can produce endless streams of (real-time) data

Data may be a lot of things

- Structured data
 - Tables, comma separated files, XML
- Unstructured data
 - Social media content

Structured Data

- Structured data is easy to handle.
 - Easy to parse
 - Easy to put into database tables
 - Easy to analyze

Unstructured Data

- More difficult to process for various reasons
 - Syntax is not semantics
 - Need to understand the context
 - A sentence may have a complete different meaning in another context
 - Computers are not good at understanding complex language
 - Example: Social media and use of irony
 - The more precise, the better
 - Example: Newspaper content vs. social media
 - But we can always extract useful information
 - Compare to traffic analysis

Open Data

- In 2011, the Norwegian government opened a portal for open data.
- The ministries and government agencies were asked to submit data sets to the portal.

Current Status

- As of today, 1126 data sets have been submitted.
- The most popular categories is shown in the list:
- <http://data.norge.no>
- Public administration: 336
- Population and society: 108
- Education, culture and sport:135
- Environment: 120
- Regions and cities: 95
- Economy: 81
- Food, fishing and agriculture: 73
- Transport: 65
- Health: 36

Open Data

- Open Data is growing, and can be combined with other data sources to make new, exiting applications.
- Open data is not only a government thing. Also companies and private persons may contribute.

Analytical Framework

- Analytical framework for smart or (intelligent) decision making in the context of smart cities.
- Based on a review of literature, white papers and news sources covering the topic, as well as empirical data from a study on air quality monitoring.

Smart Decision-making

- Smart decision-making uses a systematic approach to data collection and applies logical decision-making techniques instead of using intuition, generalizing from experience, or trial and error.

Conceptual Model

- A smart city is a city that is characterized as an “instrumented, interconnected, and intelligent”
- The “instrumentation” layer does data acquisition through sensor-based systems that provide real-time data through sensors, meters and cameras, but also from social media and open data sources.
- The “interconnection” layer integrates and transforms the data into event-related to provide rich insights for decision-making.
- The interconnection layer provides all forms of collaboration among people, processes, and systems to enable a holistic view supporting decision-making.
- At the “intelligence” layer, business intelligence and analytics are applied to the information provided by the interconnection layer and other city-relevant data and, then, the analyzed information is visualized to understand the city requirements and city policies, hence, make informed decisions and take actions.

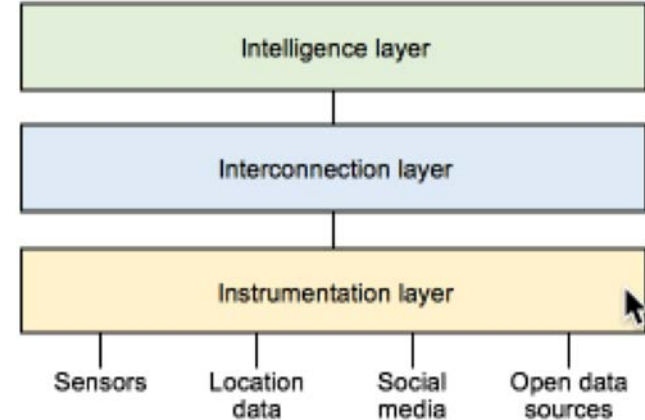

Methodology

- Literature search resulted in nine articles addressing decision-making and smart cities
- These articles were mapped into our conceptual model.
- We picked eight "smart city" application areas to get an understanding of relevant data sources.

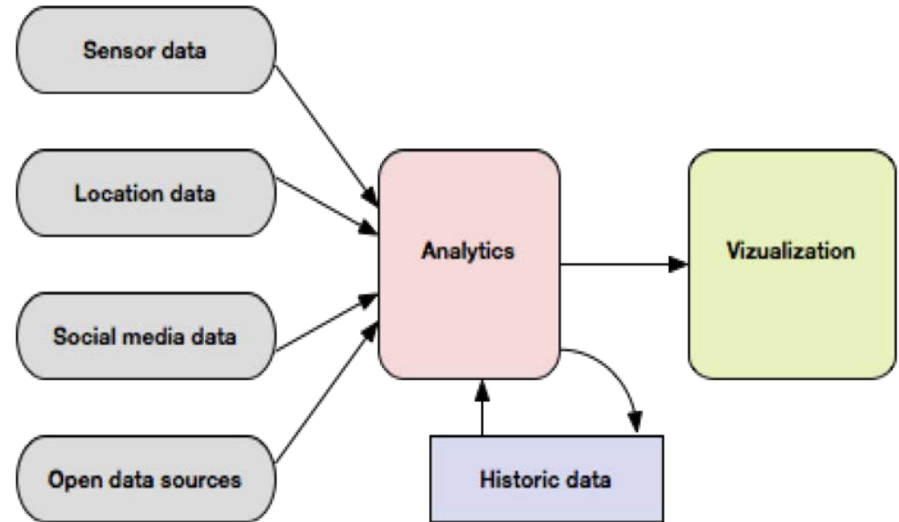

Data Sources

- Sensors (also Human Sensors)
- Location Data
- Social Media
- Open Data Sources

Application Areas

- In order to understand more about data sources and decision-making techniques, we examined some common application areas connected to smart cities. The first four areas are connected to transport:
 - Smart parking
 - Speed monitoring
 - Smart public transport
 - Smart traffic
- The rest of the application areas represent the broadness of the smart city concept:
 - Environmental monitoring
 - Energy management
 - Waste handling
 - Crime prevention

Smart Parking

- Smart parking assists drivers to find a nearby parking spot. The information provided to the driver can have many different forms, from public displays placed next to roads to mobile apps directing the driver to a free parking spot.
- Smart parking data is sensor based. Outdoor sensors may be magnetic sensors located in capsules embedded in the ground, detecting the presence of a car, or cameras detecting if a parking spot is free or not. Indoor parking spots may instead have infrared or ultrasound sensors to detect the presence of cars.
- Smart parking may also include payment solutions based on mobile phone apps, use of SMS, or dedicated devices like SmartPark™. The payment solutions may give the user the opportunity to pay for time actually used instead of paying for a fixed time period.
- Smart parking sensor data provides information to city planners and car park companies about the occupancy of parking spots over time. The collected information can be used for decision-making regarding the construction of new parking sites, and to decide on pricing.

Vehicle Speed Monitoring

- Vehicle speed monitoring warn drivers about their driving speed. The idea is to make drivers slow down if they are driving at excess speed. Speed monitoring units may be stand-alone, but state-of-the-art units are connected to the Internet and provides real-time information on driving habits.
- Several technologies have been demonstrated for vehicle speed monitoring including use of cameras, RADAR, LIDAR, and underground sensors. A measurement station is put in a fixed position, and excess speed is shown on a display device.
- Another approach is to install mandatory units in all vehicles. The driver can then be alerted of excess speed directly by the unit. Such units can also upload speed data through some kind of network.
- Vehicle speed monitoring data can be used by traffic authorities and police to decide on traffic control locations. Such data can also be used to implement speed reducing measures, such as speed bumps or traffic lights, and even control such measures in day-to-day operations.

Smart Public Transport

- One important measure to reduce environmental footprint is to reduce car traffic, in particular the use of private cars. A well-developed public transport infrastructure can be an incentive to reduce traffic load. Car owners may also be discouraged by the toll charges or congestion charges implemented in many cities.
- Smart public transport uses technology to provide public transport users with a better user experience. Use of sensors and GPS technology can provide real time data on arrivals and departures of public transport vehicles.
- Smart ticketing solutions may use smart cards or mobile phones equipped with Near Field Communication (NFC) to make ticketing more efficient from a user point of view.
- Online route planners may help users choose the most efficient route from one location to another location.
- The data collected from smart public transport can be used for real time situation reports and may also be used by public transport planners to adjust time tables, change routes, create new routes, and adjust fares.
- Social media may be mined to find citizen perceptions of the public transport system.

Smart Traffic

- Smart traffic is about using technology to ensure more efficient traffic management. Traffic management may use road lights and signs to optimize traffic flow in real time. Commercial car navigation systems provide information on fastest and shortest routes. Some navigation systems collect information from other cars real time to detect bottlenecks and provide alternative routes.
- Data may come from sensors embedded in the roads. The most common technique is to detect traffic density by embedding coils under the road surface to pick up passing cars. Alternatives are to use camera or radar technology to detect traffic.
- Data may also come from the vehicles themselves, by using radio transmissions or a cellular network.
- The data collected may be used by the city-administration for road-planning, adjusting intervals of traffic lights. Data can also be used by transport companies to decide on best schedules for pick-ups and deliveries.
- Mining social media may provide some information on how citizens experience traffic situation.

Air Quality Monitoring

- Monitoring air quality and other environmental parameters is important for decision-making. Some cities are enforcing restrictions on traffic when pollution levels reach a certain threshold.
- In most cases, the air quality monitoring is done by fixed monitoring stations located throughout the city, but may also be done by mobile handheld units, or units installed in cars.
- Measurements include gases: CO, CO₂, NO_x, and dust particles, normally 2,5 PM and 10 PM.
- Collected data can be combined with other data sources, e.g., meteorological data, to provide real time situation reports and make forecasts for future pollution levels. Data can be visualized and be made available to the public. Such data is particularly valuable for citizens with respiratory problems.
- Social media may be mined to find citizen perceptions of air quality.

Energy Management

- Smart power grids contribute to better energy management and reduced environmental footprint. An essential part of the smart grid is smart meters. Smart meters are devices that continuously measure power consumption of households and buildings.
- Household appliances can communicate with the smart meter to schedule activities when the load on the power grid is low. The smart meters also communicate with energy management systems to optimize energy consumption. Buildings can also take part in energy production through use of solar panels and other alternative energy sources.
- Sensor data may be combined with location data and open data sources to make forecasts. Social media data plays a minor role in the context of energy management.

Waste Handling

- Sorting waste materials for recycling has become common practice. Garbage collection can be improved by only collecting waste when necessary. “Intelligent” waste containers can report their state of becoming full and get included in the schedule of trucks collecting the waste.
- The recycling process itself can provide valuable data on types and amounts.
- Data from the waste collection process can be used to decide on container size and pick-up patterns. Data may also be made public to show timeliness and efficiency of the waste handling, from garbage collection through recycling.
- Social media data mining can be used to detect sentiments about the garbage collection.

Crime Prevention

- Crime prevention is about allocating police resources to areas most likely to get victims of crime, but also to find out where to establish surveillance by video cameras and other means.
- Data used for crime prevention will mostly be former reported crimes combined with open data sources, e.g., demographic data, property values, income levels of citizens, street light coverage, etc.
- Social media may be mined to find indications of unreported crimes.

Results

- Based on the literature on application areas, we made a table showing data used for decision making.
- Sensor data is very important for smart cities.
- Location data is used in several areas.
- Open data is used in combination with other data.
- Social media plays a minor role, but can be used to find citizen sentiments about services.

Application areas	Data sources			
	Sensor data	Location data	Open data	Social media data
Smart parking	X	X	-	-
Speed monitoring	X	x	-	-
Smart public transport	X	X	-	x
Smart traffic	X	x	-	x
Air quality monitoring	X	x	X	x
Energy management	x	x	x	-
Waste handling	X	X	-	x
Crime prevention	-	X	X	x

X major data source
x minor data source
- not applicable

Analytical Framework

- We ended up with the following analytical framework (figure):
- In the future, we intend to investigate how data can be analyzed using different methods and techniques, so that we can present a comprehensive model of possible combinations of data sources, actors and contexts, and analytical techniques.

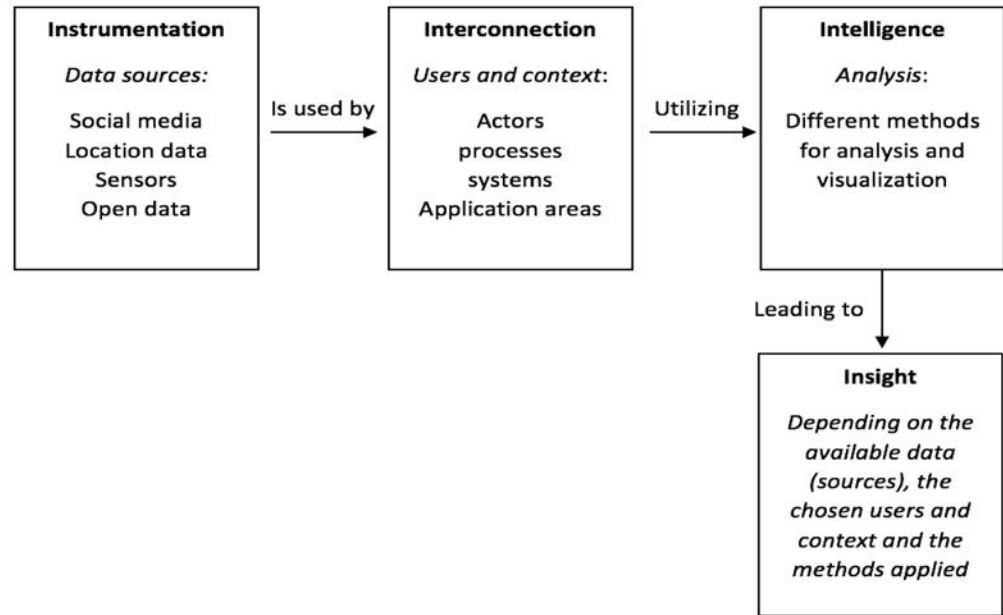

Conclusions and Future Work

- Our search for literature on decision-making in the context of smart cities only returned a few articles discussing this topic.
- We now know that this area needs more research.
- **Our examination of eight application areas shows the importance of sensor technology in smart cities.**
- Our findings will be used to further investigate analytics and visualization of “big data” coming from “smart city” sensor platforms, social media, and open data sources.

Analytics

- We have all these data from social media, open data sources and sensors.
- How do we proceed?
 - Machine learning
 - Neural networks
 - Statistical techniques (R is very popular)

A conceptual model

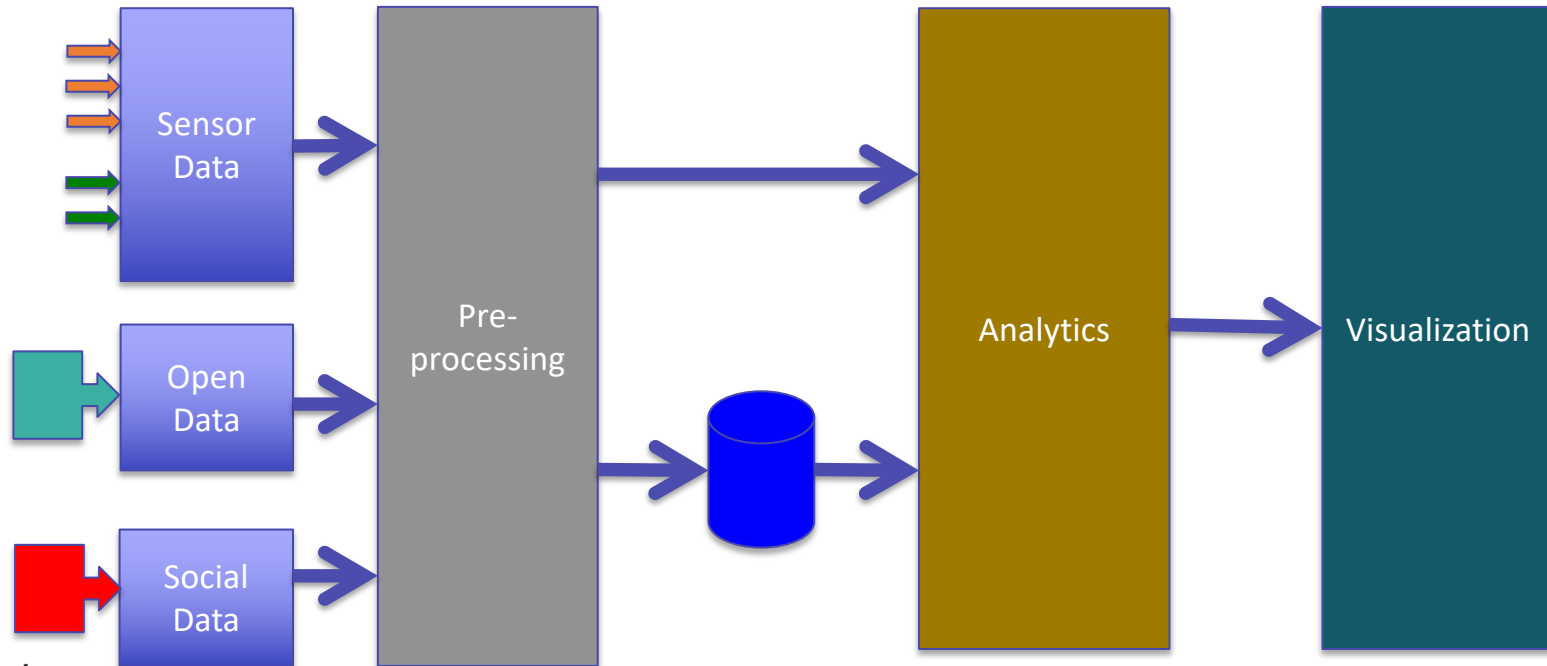

Internet of Things (IoT)

- Units able to connect and exchange information through Internet
- Gartner expects 20 billion internet-connected devices by 2020
- All kinds of devices from vending machines to jet motors in planes
- From the smart city perspective, devices with sensors and actuators are particularly relevant

https://www.gartner.com/imagesrv/books/iot/iotEbook_digital.pdf

Commercial IoT

- Amazon Echo / Alexa (Voice Controlled Personal Assistant)
- Google Dot (Voice Controlled Personal Assistant)
- NetAtmo (Weather Station)
- Philips Hue (Smart Lightbulbs)

The Use of Sensors

Lasse Berntzen



Sensors

- Analog
- Digital
- Sensors with built-in logic
- The I²C interface
- Vision and sound

Analog sensors

- The sensor delivers analog values
- These values need to be translated into digital values to be processed
- ADC – Analog to Digital Converter
- Example: Temperature sensor

Digital sensors

- Provides a digital value (on/off) or a set of digital values
- No need to convert values
- Example: Switches

”Intelligent” sensors

- The sensor contains built-in electronics to do conversion
- Often, such sensors supports polling
- I²C – a bus that uses two wires for communication

Humidity and Water Sensors

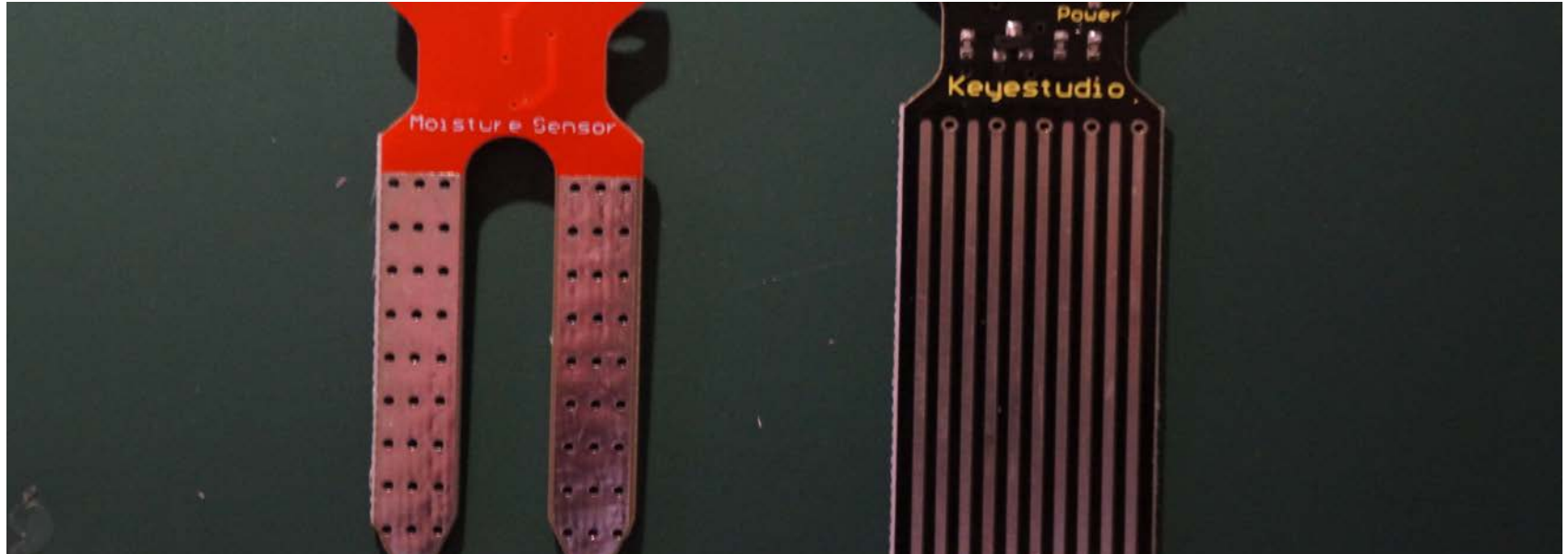

Ultrasound Distance Measurement Sensor

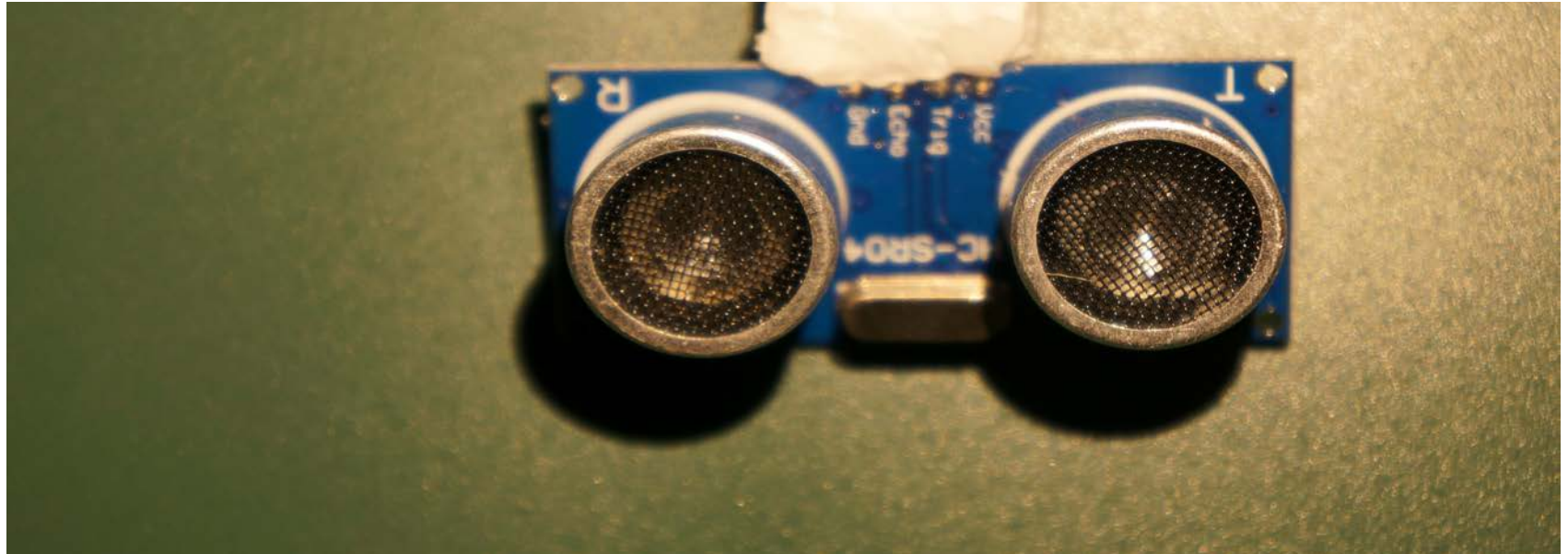

Gas Sensor

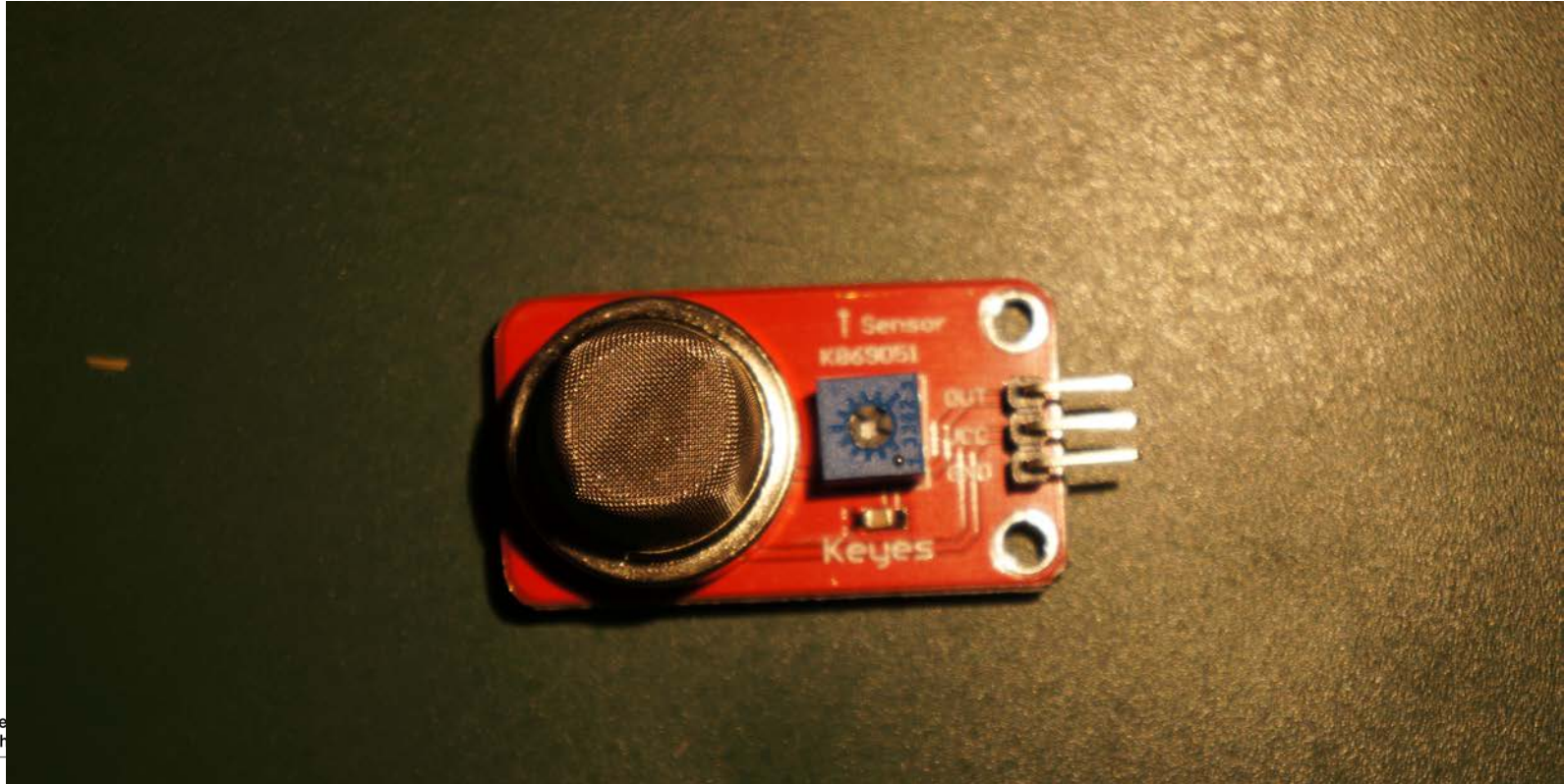

I²C

- The processing unit sends a signal to select the sensor
- The sensor responds with values

Temperature sensors



Raspberry Pi

- Cheap processing unit
- On-board Ethernet
- Memory card
- Video and HDMI
- Audio
- Four USB ports

Raspberry Pi

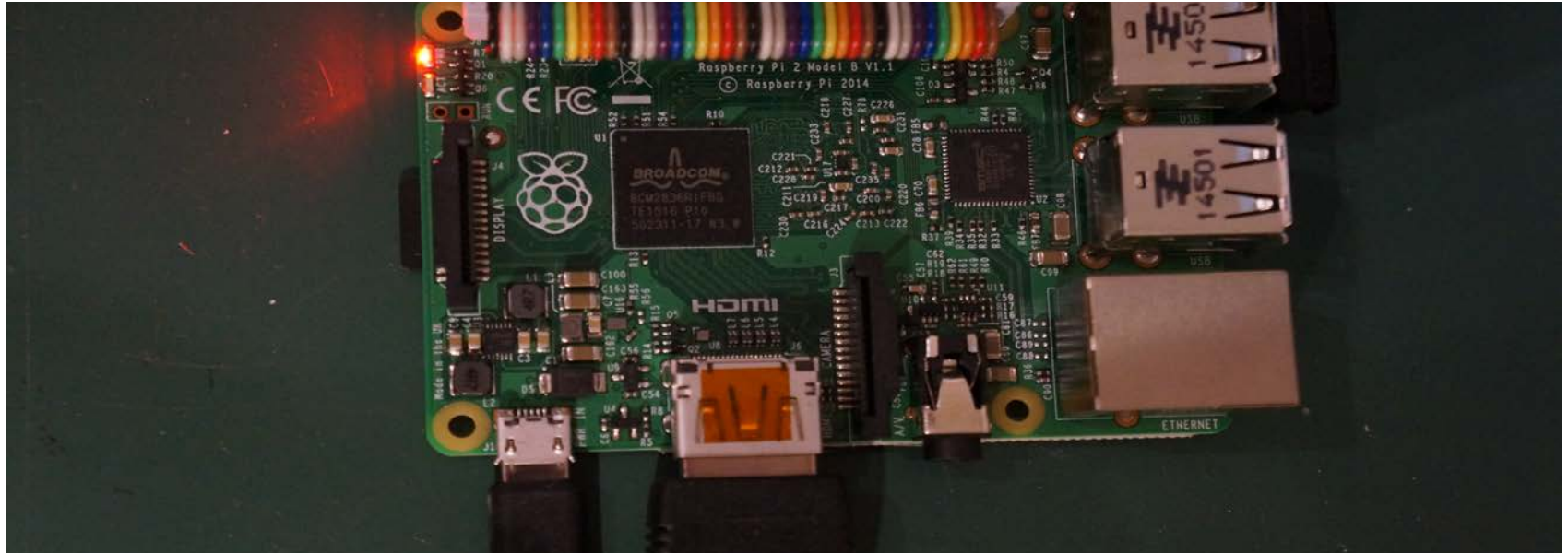

Raspberry Pi Development Environment

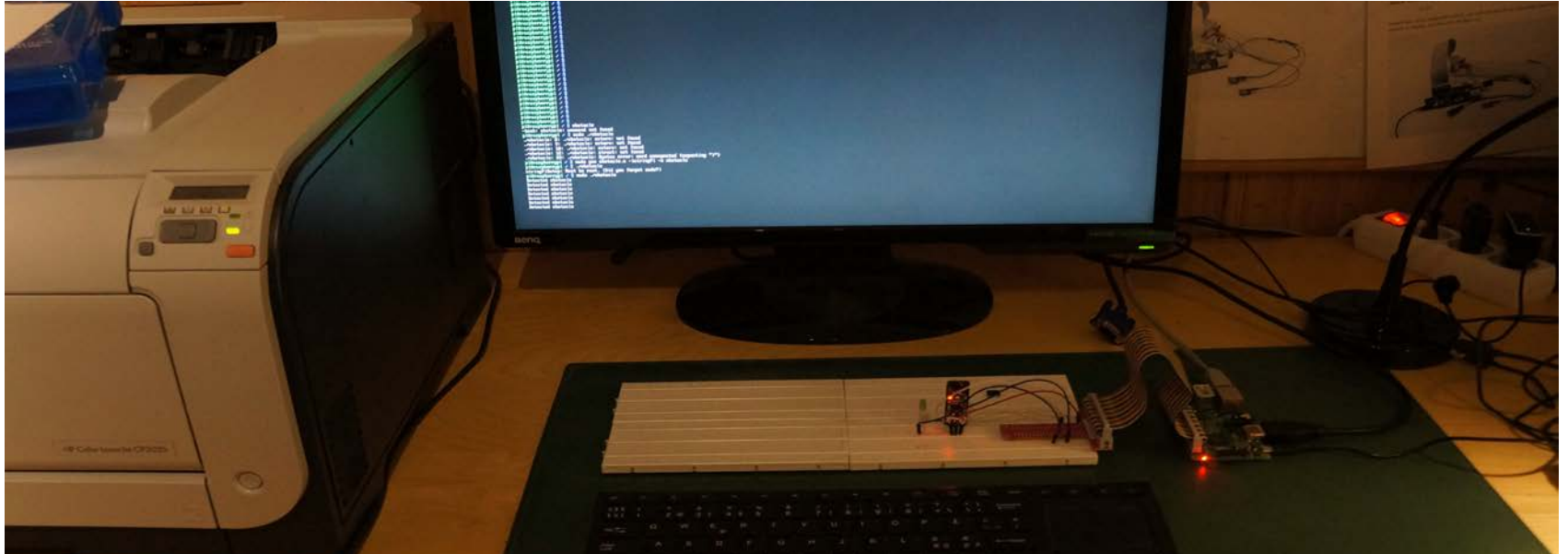

Example: Obstacle sensor

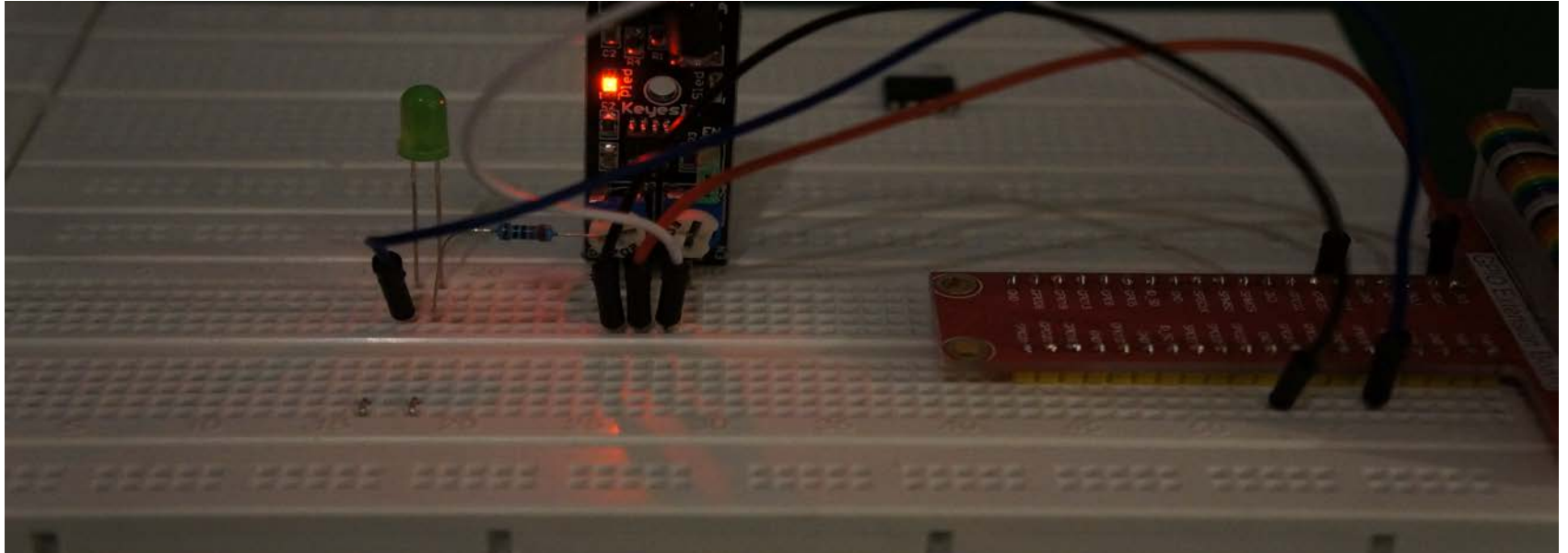

Example: Obstacle sensor

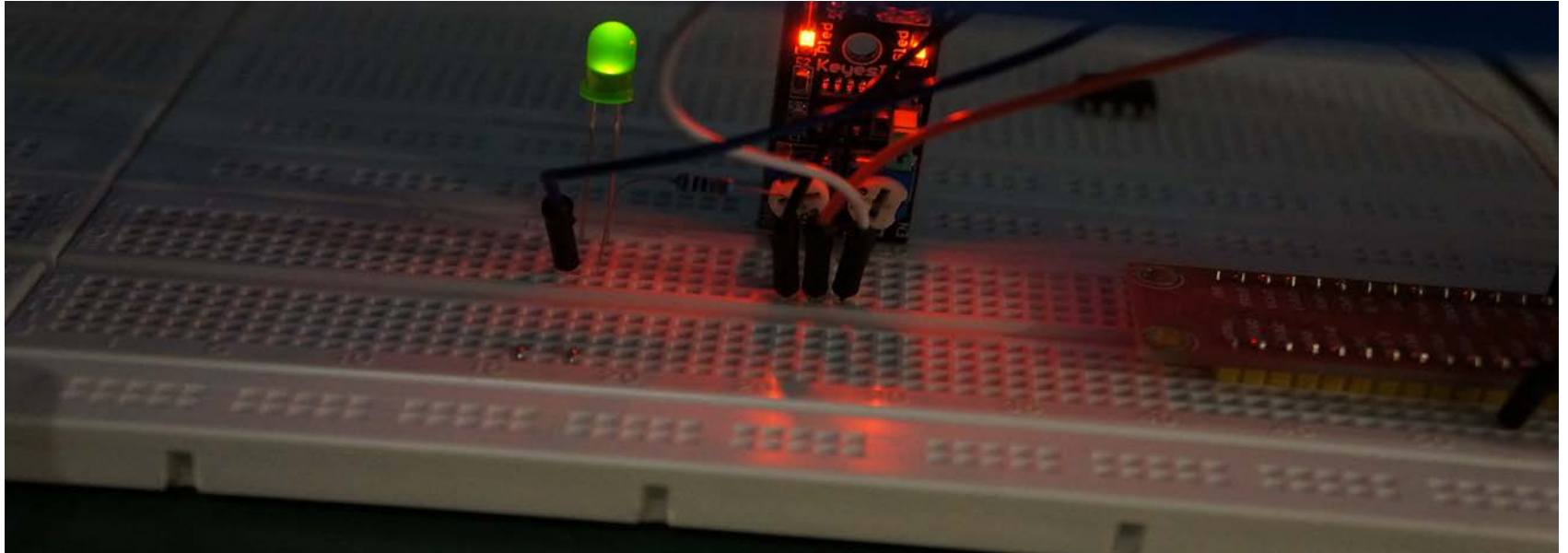

Raspberry Pi Example

```
#include <wiringPi.h>
#include <stdio.h>
#include <stdlib.h>
#define ObstaclePin 0
#define LedPin 1
int main(void){ if(wiringPiSetup() == -1){
    printf("Setup failed"); return 1; }
```

```
    pinMode(ObstaclePin, INPUT);
    pinMode(LedPin, OUTPUT);
    while(1){ if(digitalRead(ObstaclePin)==LOW){
        delay(25);
        if(digitalRead(ObstaclePin)==LOW){
            printf("Detected obstacle\n");
            digitalWrite(LedPin,HIGH);
            delay(2000);
            digitalWrite(LedPin,LOW);
        }
    }
}
return 0;
}
```

Demo: Obstacle Sensor

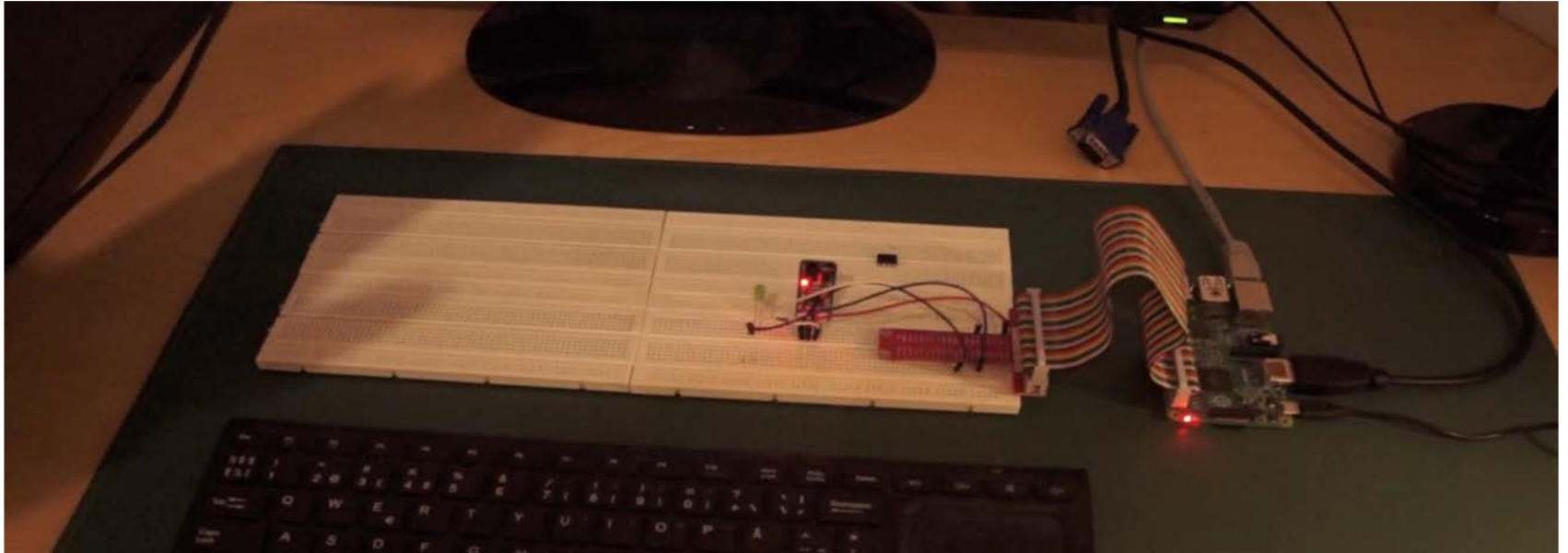

Arduino

- Cheap, open source processing unit
- Supports both analog and digital inputs
- Arduino can be enhanced by shields
- A shield is a circuit board that is put on top of the Arduino

Arduino

- This is one example of a shield providing a LCD display and six buttons.
- This shield was used to implement a stopwatch application.

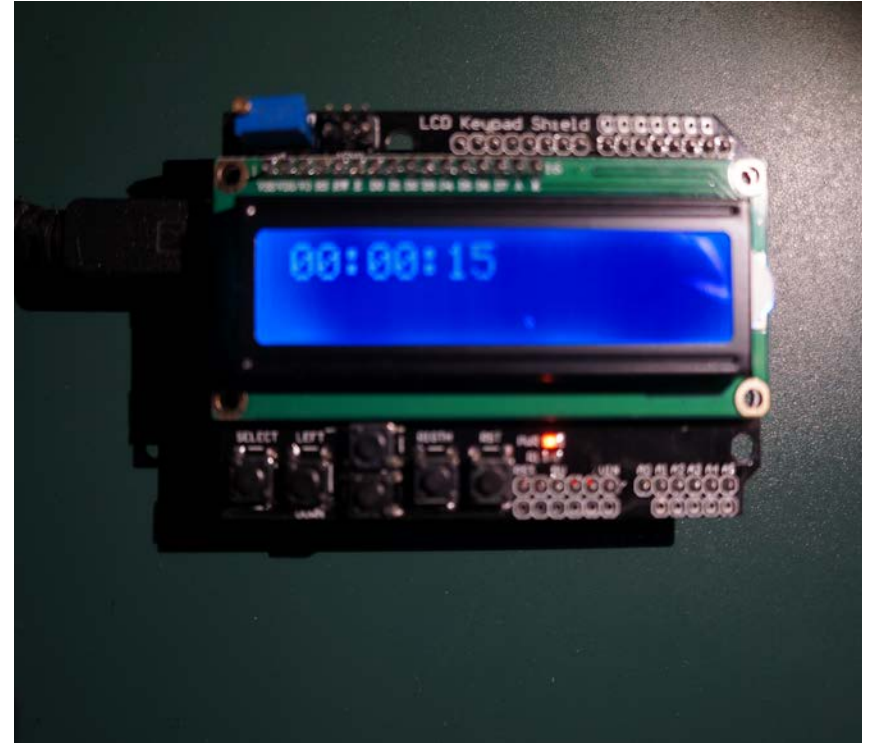

Shield

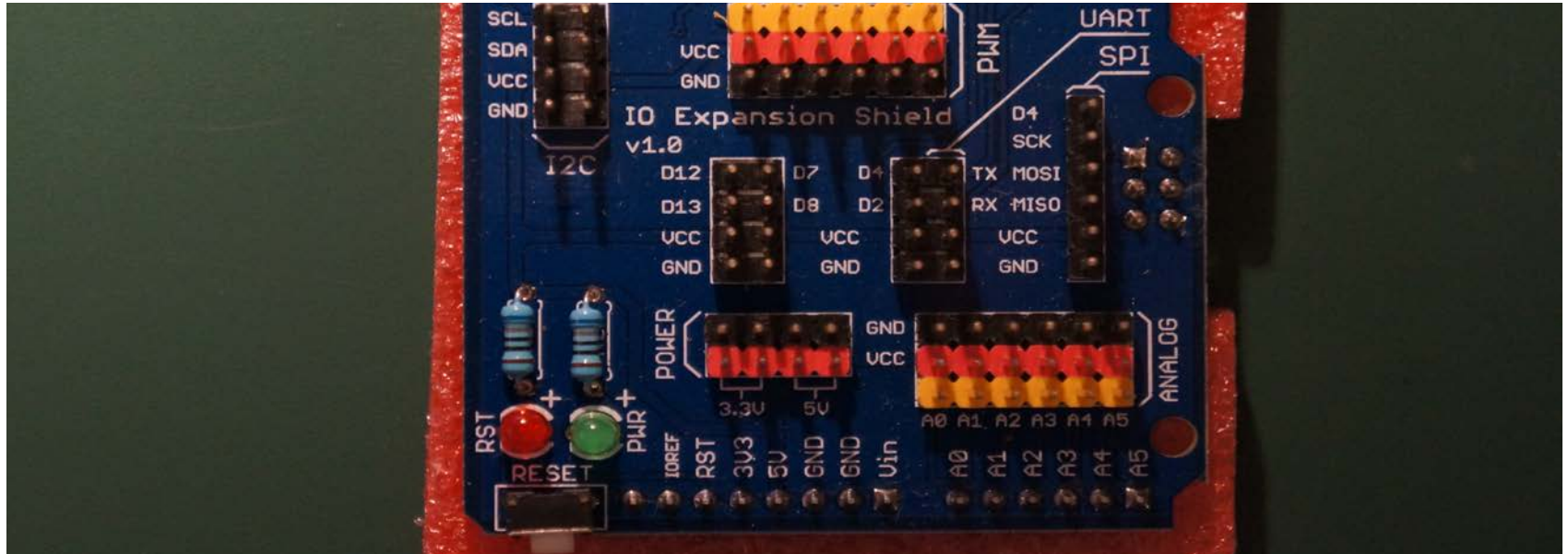

Demo: Arduino + LAN Shield

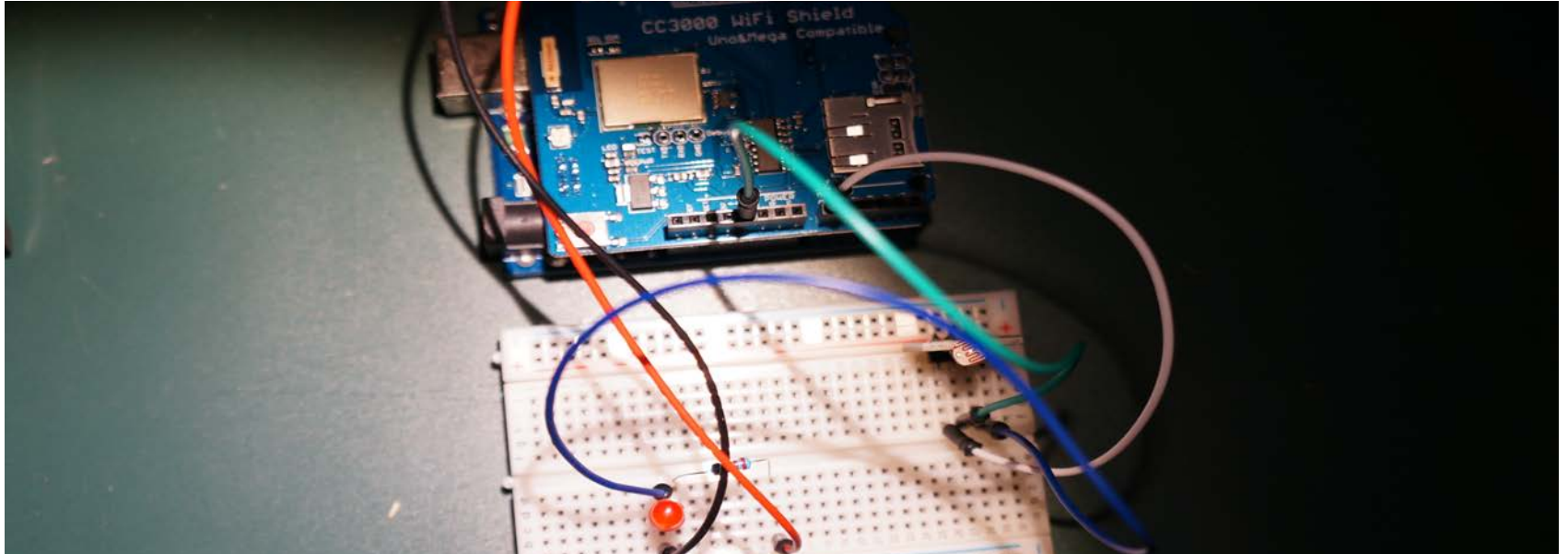

Using a Light Sensor

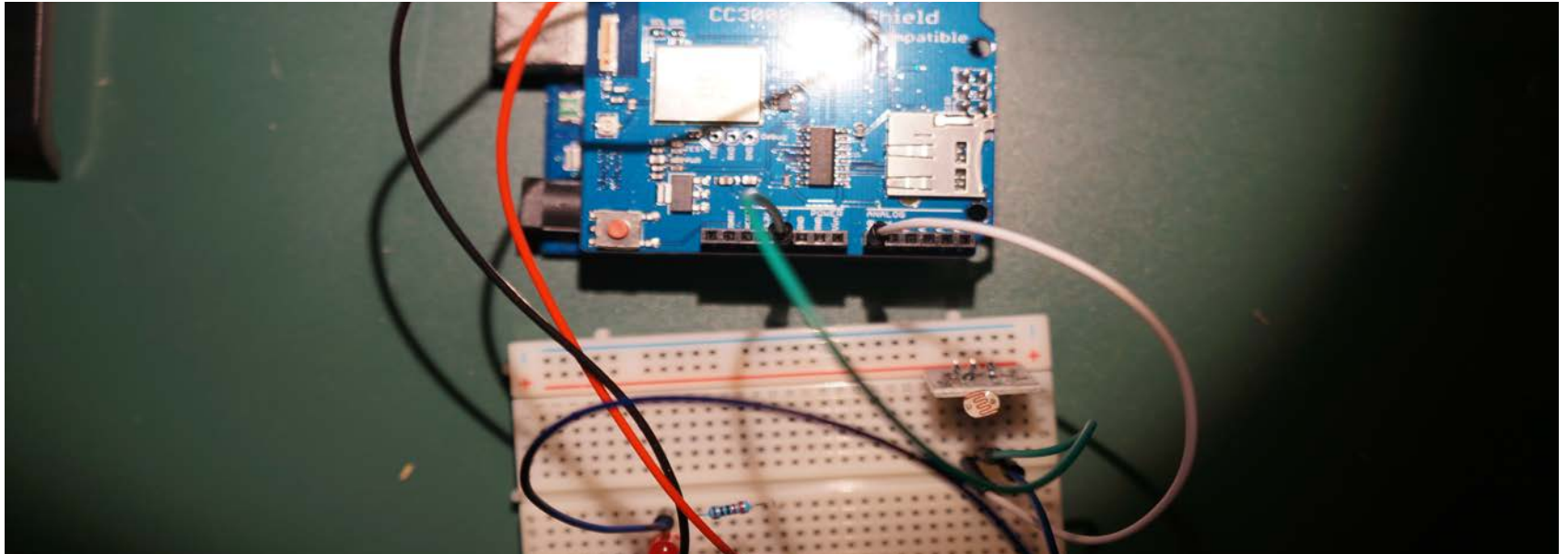

Using a Light Sensor

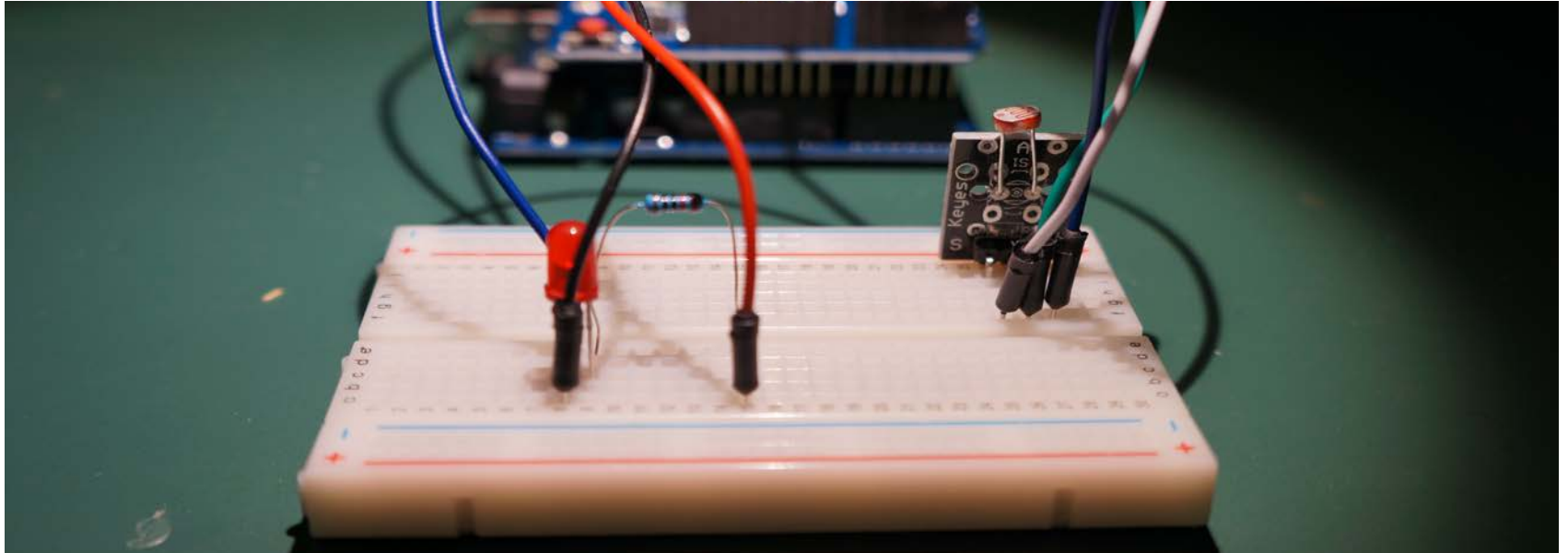

Mobile (GSM) Unit



Gesture Sensor

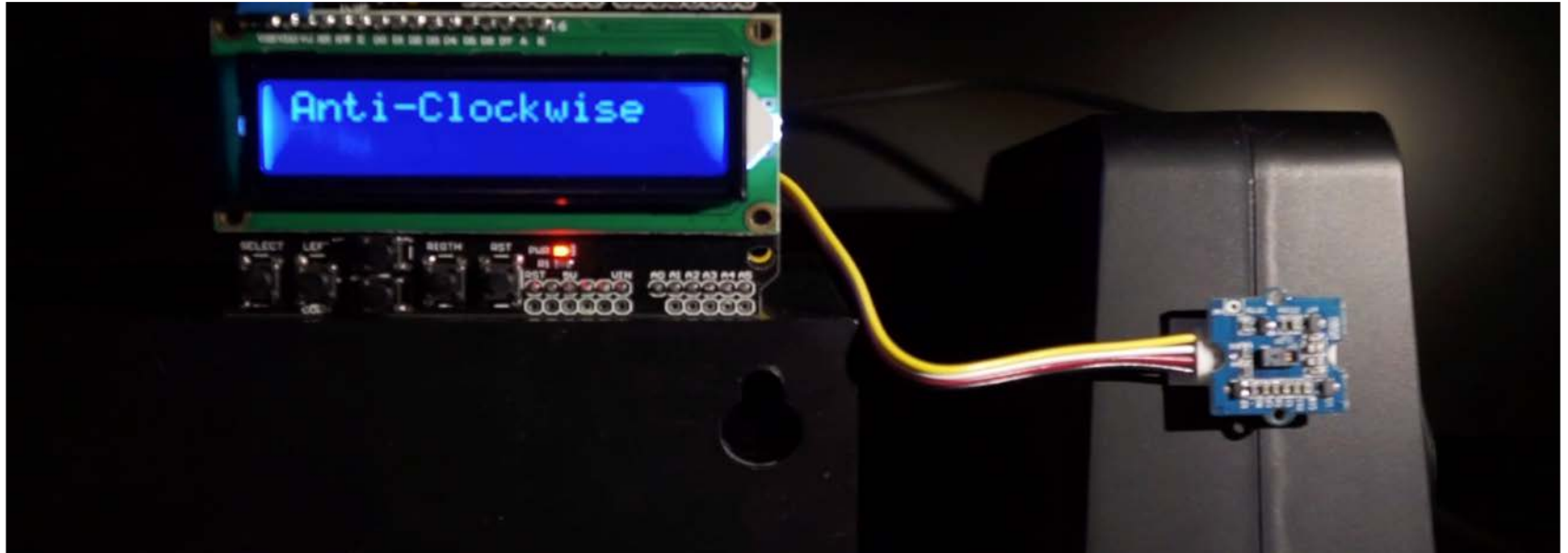

Arduino with LCD shield and gesture sensor

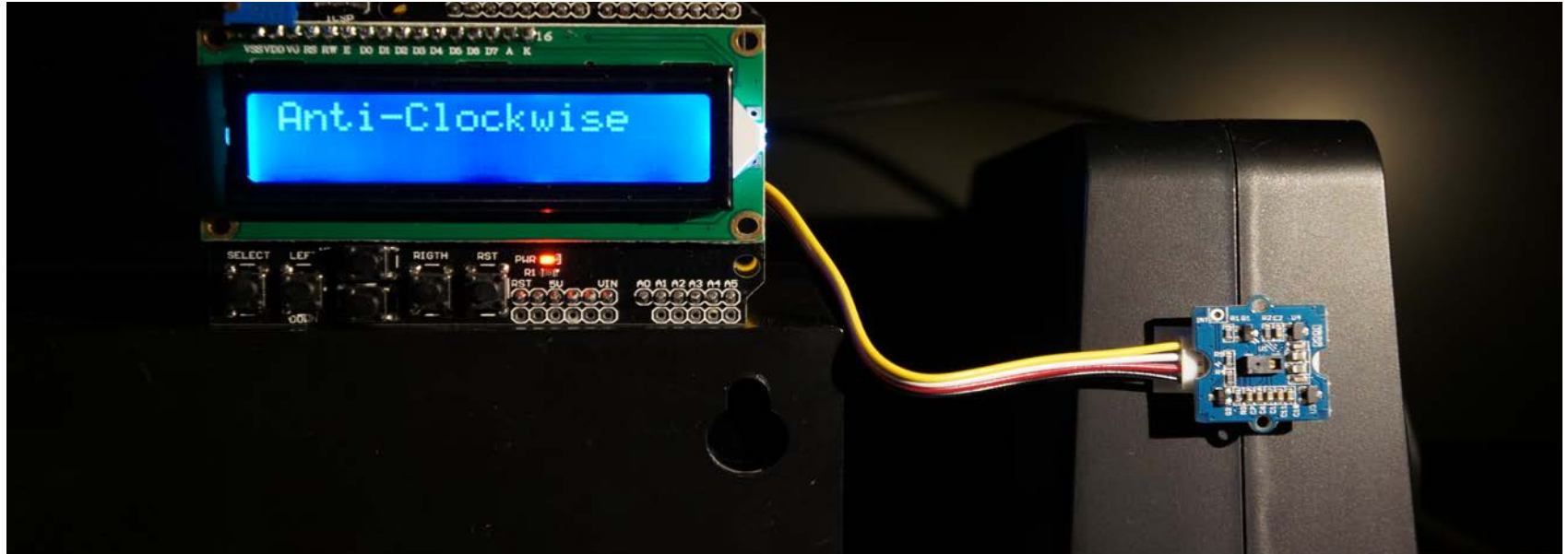

Citizens as Sensors

- Citizens collect data using their own senses and make an action to report their observations, but they can also be sensor platforms by carrying sensors around.
- We define a “human sensor” as a citizen that helps collect data about his/her surroundings.
- Examples:
 - FixMyStreet
 - Sauberes Wiesbaden

Monitoring Air Quality IoT in the Smart City

Lasse Berntzen



Introduction

- One of the key areas of smart cities is environment.
- Environmental monitoring provides current conditions and can be used to find trends
- The results can be used for decision making.

The Context

- Every winter, Oslo and Bergen, the capital and the second largest city of Norway, have severe problems with air quality.
- The air quality problems are caused by certain climatic conditions that put a lid on top of the cities.

Measures

- Bergen use the last digit on the number plate to decide what day you are allowed to drive in the city.
- Oslo is considering different approaches, like raising the toll fees or restricting the types of cars allowed to drive in the city.
- On Tuesday, January 17th 2017, cars using diesel were not allowed to drive in Oslo. The ban was lifted in the evening the same day.

How are Decisions Made?

- Each city has a limited number of stationary measurement units. Oslo has seven units.
- Pollution may vary with location
- Low granularity gives inaccurate readings
- Decisions may not reflect the real situation

Citi-Sense

- European Union – funded project
- Made mobile hand-held units
- Need people to carry them around

Our Goals

The ultimate goal is better decision making through improved analysis and data collection.

- More units provides better granularity
- Mobile units make it possible to measure at more locations
- Inexpensive units make data collection feasible

Our Approach

- Mobile unit
- Installed in cars
- Starts collecting information when car is parked
- Transmits information to central server.

Project Organization

- This project is done in collaboration between Faculty of Engineering, “Lucian Blaga” University of Sibiu”, Romania and University College of Southeast Norway.
- Three students built the first prototype during their mobility stay in Norway (Two from Sibiu, one from Craiova).
- EEA grant

First Prototype

- The first prototype used Intel Edison as processing unit
- Communication was handled through Bluetooth connection to a mobile phone
- GPS unit provided location information
- Sensors for barometric pressure, temperature, humidity, sound, and CO₂,

Lessons Learnt – First Prototype

- Use of Android phone for communication requires a phone with a subscription. App need to be installed. Not good for larger deployments.
- Sound sensor had limited use
- Intel Edison is a quite expensive processing unit

Second Prototype

- Based on LinkIt Duo, a cheap dual processing unit.
- Combined GPS and GSM unit
- No sound sensor
- Added a particle sensor
- Replaced CO₂ sensor with sensor able to also measure NO_x

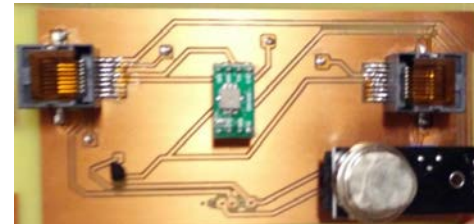
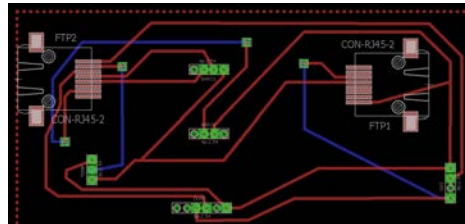

Second Prototype

- 16 environmental platform sensors has been made in Sibiu.
- First test in Sibiu, February 2017
- Collaboration with Romanian National Environmental Agency and CitizenAlert (NGO)
- Planning larger project with more than 100 units.
- Unit cost: Around Euro 120,-

Lessons Learnt – Second Prototype

- Availability of components may be a problem
- GSM modem need to be compatible with operator (2G/3G/4G)
- Quality of sensors should be verified

A Low-Cost Smart Parking System for Private Parking Space Management



STEPHAN BÖHM, HOLGER DRIEHAUS, LASSE BERNTZEN

29.09.2017



Hochschule RheinMain
University of Applied Sciences
Wiesbaden Rüsselsheim Geisenheim

UN University of
South-Eastern Norway

Media
Management



INFORMATIK 2017



Hub



New



Spaces



Cars



Menu

WI-AA-123

09/29/2017 – 8 am

09/30/2017 – 5 pm



Notify me when the guest arrives

Make Reservation



RESEARCH BACKGROUND

EXISTING SYSTEMS ARCHITECTURE

GENERAL ARCHITECTURE³

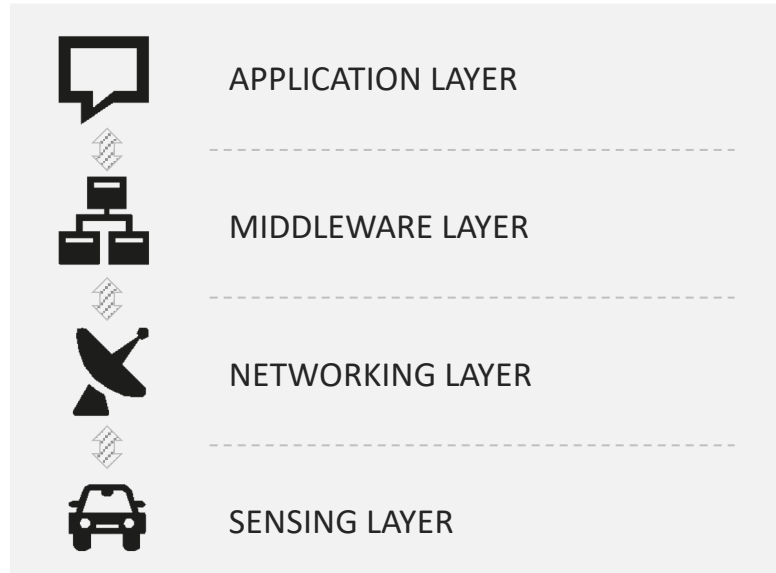

³ Bagula et al. (2015): On the design of smart parking networks in the smart cities: An optimal sensor placement model.



VARIANTS (2/2)

TASK ALLOCATION: IMAGE PROCESSING

MICROCONTROLLER

Capturing Image

⇒ image.jpg ⇒
⇐ response.txt ⇐

CLOUD/SERVER

License Plate Recognition
& Parking Management System



PROTOTYPE COMPONENTS (1/2)

ARDUCAM WITH ULTRASOUND

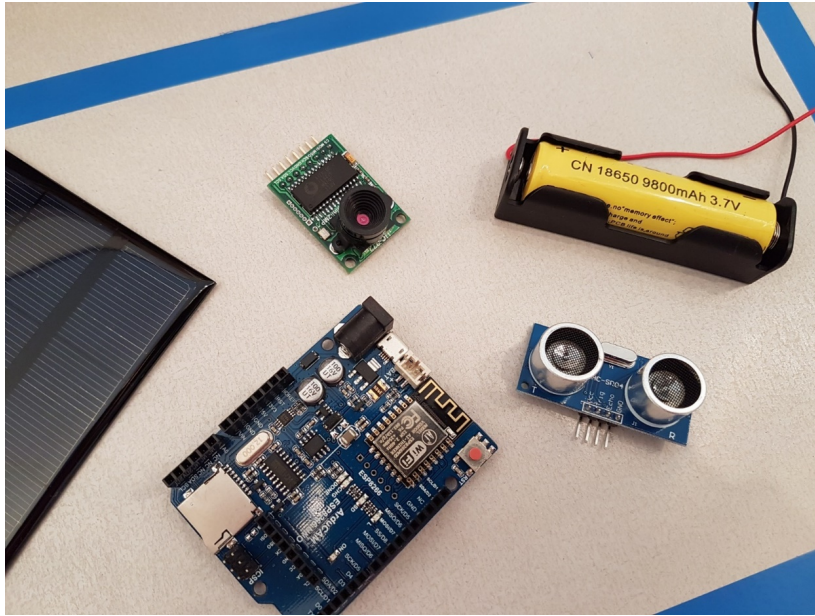

- ArduCam ESP8266 Uno V2 (16,50 EUR)
- ArduCam Mini 2MP (OV2640) (28,50 EUR)
- Ultrasound Module (HC-SR04) (4,50 EUR)

Future Components

- Solar Panel 5W
- Lithium Batteries 18650



PROTOTYPE COMPONENTS (2/2)

OPENALPR (CLOUD API)

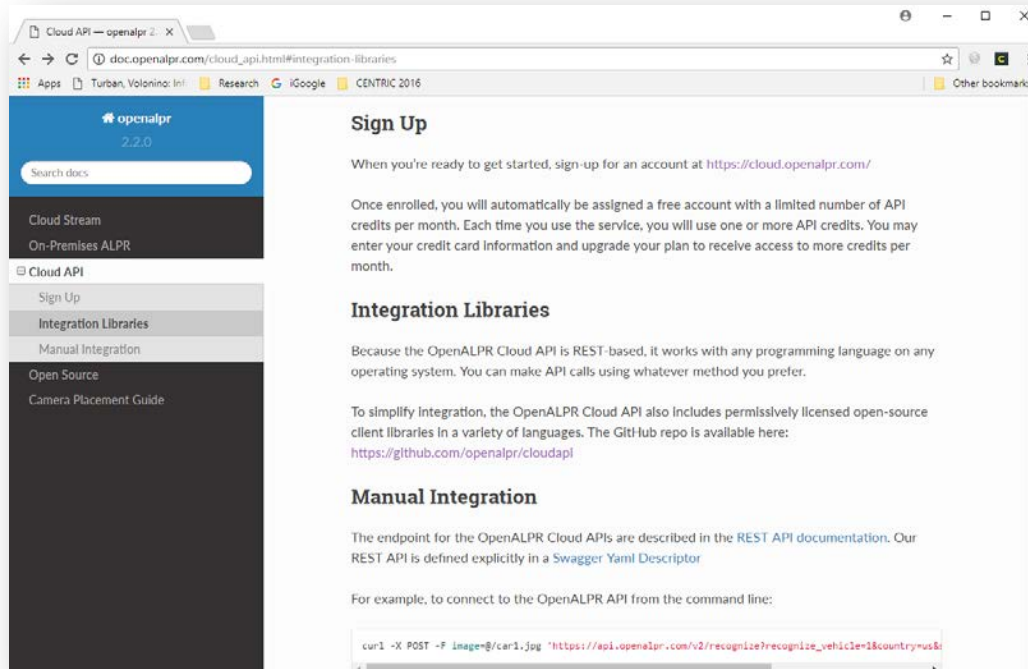

- Cloud-based Solution
- 2000 API credits per month free
- Web-based REST service
- Returns JSON data describing the license plate and vehicle
- Integration libraries available (GitHub repo)
- PHP library used for prototype



PRETEST IMPLEMENTATION

PROTOTYPE FOR TESTING (FUNCTIONAL MODEL/PROOF-OF-CONCEPT)

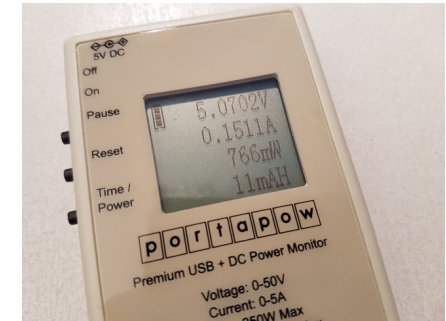

766 mW = 18,384 mWh/day
Sleep Mode/Wake-up Strategy
required!



PROTOTYPE IN ACTION

PROOF-OF-CONCEPT



- Distance is measured and triggers license plate recognition
- Image is captured by the ArduCam board and send to a webserver
- OpenALPR request is processed by a PHP library
- Recognition time could be reduced by a direct request
- Works quite robust but needs optimization



LOW-COST SYSTEM

KEY FEATURES



Opportunities

- The Internet of Things (IoT) provides the infrastructure for a data-driven Smart City
- Sensor data can be combined with other data to make better decisions

Making Better Decisions

- We need to:
 - Collect data from many sources
 - Convert to information elements
 - Store and analyze information
 - Visualize the information to give better background for decisions
 - Make the decisions
- Decisions may be automated

Key Challenges

- Overlapping, aging infrastructure
- Integration of subsystems / connectivity
- Using «Big Data» to make better decisions
 - Internet of Things (IoT)
 - Mining the web and open data sources
 - Visualize results
- Real participation
- Privacy

Thank you for listening

If you are interested, please stay in touch
lasse.berntzen@usn.no