



# Edge and fog computing - convergence of solutions?

**Eugen Borcoci**

University POLITEHNICA Bucharest (UPB)

*Eugen.Borcoci@elcom.pub.ro*



# Edge and fog computing - convergence of solutions?



## Acknowledgement

1. This overview is compiled and structured, based on several public documents belonging to different authors and groups, on Cloud/Fog, IoT, Multi-access Mobile Edge Computing, SDN, NFV, 4G/5G networking, etc.: conferences material, studies, research papers, standards, projects, overviews, tutorials, etc. (see specific references in the text and Reference list).

2. Given the extension of the topics, this presentation is a high level overview only.



# Edge and fog computing - convergence of solutions?



## Motivation of this talk

### Facts:

- **Novel services, applications and communication paradigms based on Internet technologies**
  - Internet of Things (IoT)- including industry and agriculture, Smart cities, M2M, Vehicular communications, Content/media oriented communications, Social networks, Big data applications, etc.
    - “Internet of Everything” (IoE)
- **Supporting technologies** (used in cooperative mode)
  - *Cloud Computing (CC)*
  - *Edge oriented computing*
    - *Multi-access/Mobile Edge Computing (MEC)*
    - *Fog Computing (FC/EC)*
    - *Cloudlets, ..*
- **Auxiliary technologies**
  - *Virtualization techniques*
  - *Software Defined Networks (SDN)*
  - *Network Function Virtualization (NFV)*



# Edge and fog computing - convergence of solutions?



## Motivation of this talk (cont'd)

### Facts and Trends:

- **Cloud computing (CC) services** offered by data centers (including public/private/community clouds) – intensively used
- **However, centralisation** (processing and storage) in traditional CC -> some **limitations**, being non-appropriate for specific classes of apps.
- **Services and apps. like IoT, mobility-related, M2M, ..**
  - **requirements:** Low latency/response time, high bandwidth, location and context awareness, reduction in amount of data transferred to CC and back
- **Network/Edge/User terminal devices: more powerful** (in terms of processing, storage, communication capabilities)
- **Solution:** to push additional CC capabilities to the network edge
- Different proposals exist for **edge-oriented** computing:
  - Multi-access/Mobile Edge Computing
  - Fog Computing
  - Cloudlets, ..
- **Question :** any convergence in terms of concepts, architecture and implementation of such solutions?

ComputationWorld 2018 Conference February 18, 2018, Barcelona



# Edge and fog computing - convergence of solutions?



## Motivation of this talk (cont'd)

- **Industry and Std. Organizations** –active in edge-oriented computing
  - **Fog Computing (FC)** - *CISCO* (~ 2012)
  - **Open Fog Consortium** (Nov. 2015) : founders: Cisco, ARM, Dell, Intel, Microsoft , Princeton Univ. Edge Laboratory
    - more than 60 members today
    - definition of FC and Open Reference Architecture
    - the first step in creating standards to enable interoperability in IoT, 5G, artificial intelligence, tactile internet, virtual reality and other complex data and network intensive applications
  - **ETSI (>2014): Mobile Edge Computing** Industry Specification Group
    - March 2017 - renamed as: **Multi-access Edge Computing ISG** - to better reflect non-cellular operators requirements
  - ..
- **Cooperation started between** *Open Fog Consortium* , *ETSI MEC ISG*, etc.
  - to give the industry a cohesive set of standards around fog computing in mobile environments, while eliminating redundancy



# Edge and fog computing - convergence of solutions?



## Motivation of this talk (cont'd)

- **Industry and Standardization Organizations** – active in edge-oriented computing
  - **Edge Computing Consortium** (Dec. 2016)
    - Founders : Huawei, Intel, ARM; now + others
  - **US National Institute for Science and Technology (NIST)**
    - definition of FC (draft closed in September 2017)
  - **IETF**
- **Market Predictions:** The FC market will exceed \$18bn by 2022 ..
- Several predictions (Gartner, IDC, HIS Markit, etc.): 20-30 billion of IoT devices installed until 2020 → Edge/fog computing will be a must
- Organizations that rely heavily on data are increasingly likely to use **cloud, fog, and edge** computing infrastructures



# CONTENTS



1. Introduction
2. Multi-access Edge Computing (MEC)
3. Fog Computing
4. Cloudlets
5. Convergence and open research topics
6. Conclusions



# CONTENTS



1. **➔ Introduction**
2. **Multi-access Edge Computing (MEC)**
3. **Fog Computing**
4. **Cloudlets**
5. **Convergence and open research topics**
6. **Conclusions**





# 1. Introduction



- **Edge-oriented computing**
- **Edge computing (EC) – generic definition**
  - Part of CC capabilities and operations are offloaded from **centralised CC Data Center (CCDC)** to the *network, edge and/or terminal devices*
  - EC provides context aware storage and distributed computing at the network edge
- **Specific definitions**
  - **Fog Computing (FC)** - (CISCO ~ 2012)
    - Initial definition (Bonomi- [1], [2-4]): *“highly virtualized platform providing **compute, storage and networking services** between end devices and traditional CCDC typically, but not exclusively located at the edge of the network”*.
    - Driving factor for FC: IoT
    - Initial vision on FC: it will not replace CC; they are complementary
    - FC is extended on a **continuum of devices from CCDC down to the edge of networks**, for secure management and control (M&C)
      - of domain specific HW/SW
      - and standard compute, storage and network functions within the domain
    - FC enable secure rich data processing applications across the domain
    - FC nodes (FCNs) are typically located away from the main cloud data centers



# 1. Introduction



## ■ Edge-oriented computing

- **Mobile Edge Computing (MEC)** – ETSI - an industry spec. ~2014, [5-7]
  - MEC was a model for enabling business oriented, CC platform within **the Radio Access Network (RAN)** close to mobile subscribers to serve delay sensitive, context aware applications
  - CC capabilities go close to the **Radio Access Networks** in 4G, 5G
  - **ETSI** : defined a system architecture and std. for a number of APIs
  - **Multi-access Edge Computing** – recent extension (>2016) of the initial MEC
    - MEC means today – **multi-access...to include non-cellular actors**
- **Cloudlet** – developed by *Carnegie Mellon University* ~2013) [8-9]
  - A cloudlet is middle tier of a 3-tier hierarchy: ‘**mobile device – cloudlet – cloud**’
  - Cloudlet ~ "**data center in a box**" whose goal is to "bring the cloud closer"
  - **Cloudlets are mobility-enhanced *micro data centers* located at the edge of a network and serve the mobile or smart device portion of the network**
    - designed to handle resource-intensive mobile apps. and take the load off both the network and the CCDC and keep computing close to the point of origin of information



# 1. Introduction



- **Edge-oriented computing**
  - **Micro data centre** – developed by *Microsoft Research*- ~2015 [10]
    - extension of today's hyperscale cloud data centers (e.g., Microsoft Azure)
    - to meet new requirements: lower latency, new demands related to devices (e.g. lower battery consumption)
  - **Edge computing**
    - **Open Fog consortium definition:** “also referred to as Mesh Computing, it places applications, data and processing at the logical extremes of a network. Placing data and data-intensive applications at the edge reduces the IoT volume and distance that data must be moved”
- **The above approaches include partially overlapping concepts and are complementary**



# 1. Introduction



- **Edge-oriented computing - visions**
- **Current status: no unique vision, terminology and definitions!!**
- **Examples**
- **OpenFog Consortium vision on FC and EC**
- **Fog computing :**
  - **A horizontal, system-level arch. that distributes computing, storage, control and networking functions closer to the users along a cloud-to-thing continuum.**
  - FC - extends the traditional CC model; implementations of the architecture can reside in multiple layers of a network's topology
  - the CC benefits are extended to FC (containerisation, virtualisation, orchestration, manageability, and efficiency)
  - FC can cooperate with CC
  - **OpenFog reference arch.** includes security, scalability, openness, autonomy, RAS (reliability, availability and serviceability), agility, hierarchy, and programmability
- **EC is seen as different from FC**
  - FC works with the cloud, whereas EC is defined by the exclusion of cloud.
  - FC is hierarchical, where edge tends to be limited to a small number of layers
  - In addition to computation, FC also addresses networking, storage, control and acceleration.

*Source[ 11-12]: OpenFog Reference Architecture for Fog Computing, 2017,  
[www.OpenFogConsortium.org](http://www.OpenFogConsortium.org)*

ComputationWorld 2018 Conference February 18, 2018, Barcelona



# 1. Introduction



- **Edge-oriented computing – visions**
- **Examples (cont'd)**
- **NIST visions of Fog Computing [13]**
  - **FC** : horizontal, physical or virtual resource paradigm that resides **between smart end-devices and traditional cloud or data centers.**
  - **FC** supports vertically-isolated, latency-sensitive applications by providing ubiquitous, scalable, layered, federated, and distributed computing, storage, and network connectivity
  - **Fog Computing Characteristics**
    - Contextual location awareness, and low latency
    - Geographical distribution with predominance of wireless access
    - Large-scale sensor networks
    - Very large number of nodes
    - Support for mobility
    - Real-time interactions
    - Heterogeneity
    - Interoperability and federation
    - Support for real-time analytics and interplay with the Cloud

*Source [13]: M.Iorga et. al., NIST Special Publication 800-191 (Draft) 1, The NIST Definition of Fog Computing, 2017*

# 1. Introduction

- Edge-oriented computing- visions
- Examples (cont'd)
- NIST definition of Fog Computing

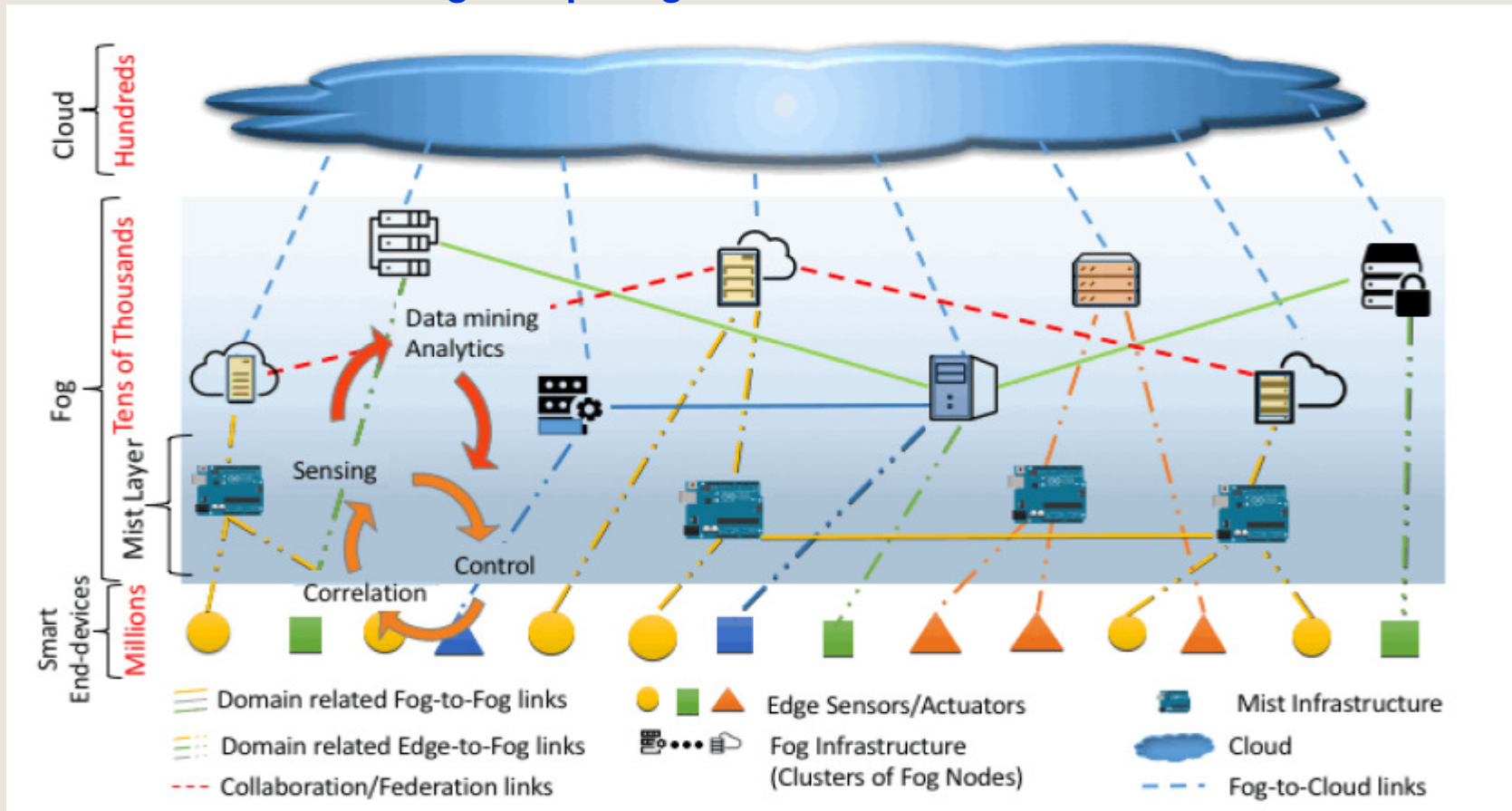

Source [13]: M.Iorga et. al., NIST Special Publication 800-191 (Draft) 1, The NIST Definition of Fog Computing, 2017

- **Edge-oriented computing - visions**
- **Examples (cont'd):**
  - **Multi-access Edge Computing (MEC) -ETSI:** cloud capabilities (compute, storage and networking infrastructure) moved close to the user, at the **edge of a network**.
  - **Main entities: MEC servers** - are usually hosted typically at access points, *one hop away from the user*.
  - **Fog computing** is seen here as a superset of edge computing
    - FC - essentially *including everything that is not a central cloud*.
  - *Source[14]: Innovations in Edge Computing and MEC (Latest in Multi-access Edge Computing, Fog Computing, Distributed Clouds), 2017, <http://www.linkedin.com/in/kmsabidurrahman/>*

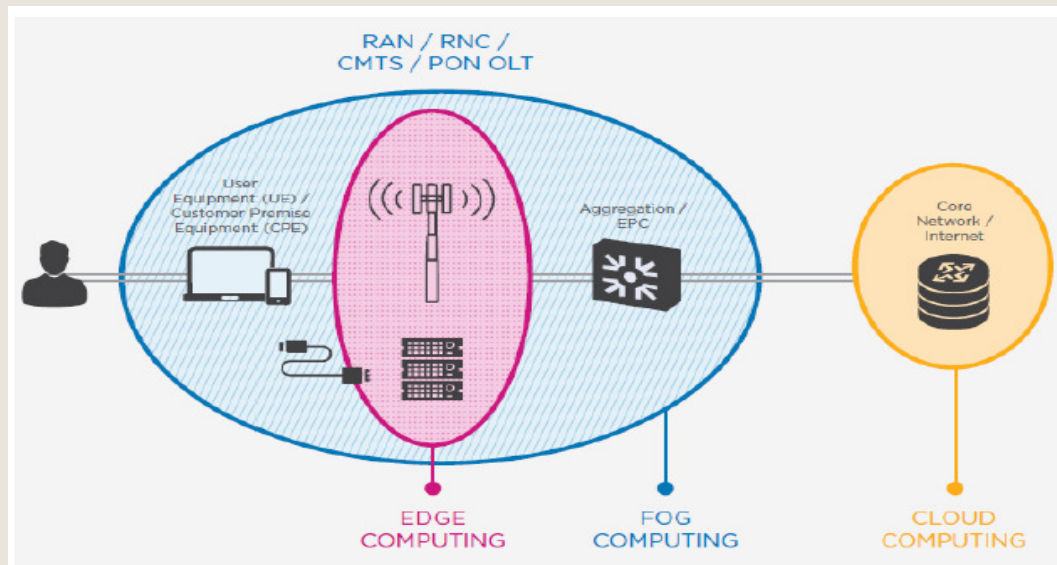

- **RAN** - Radio Area Network for LTE/5G
- **RNC**- Radio Network Controller for WiFi
- **CMTS**- Cable Modem Termination System
- **PON OLT** for fiber
- **EPC** – evolved Packet Core



# 1. Introduction



- **Edge-oriented computing – visions; Examples** (cont'd)
- **Traditional - Edge Computing (EC)** : M&C of a standalone end-point device individually or through a set SW functions in the fog domain (e.g.control of a printer, security camera, traffic light, robots, machines, etc.)
  - EC devices /entities within the domain are *standalone* or *interconnected through proprietary networks* with custom security and little interoperability.
- **Modern EC** redefine the EC scope by including some functions of FC (e.g., interoperability, local security etc.), but does not extend to the central cloud or across domains.
  - The current EC domain is a sub-set of Fog Computing domain.
- **Comparison of Cloud Computing, Fog Computing, and Edge Computing**

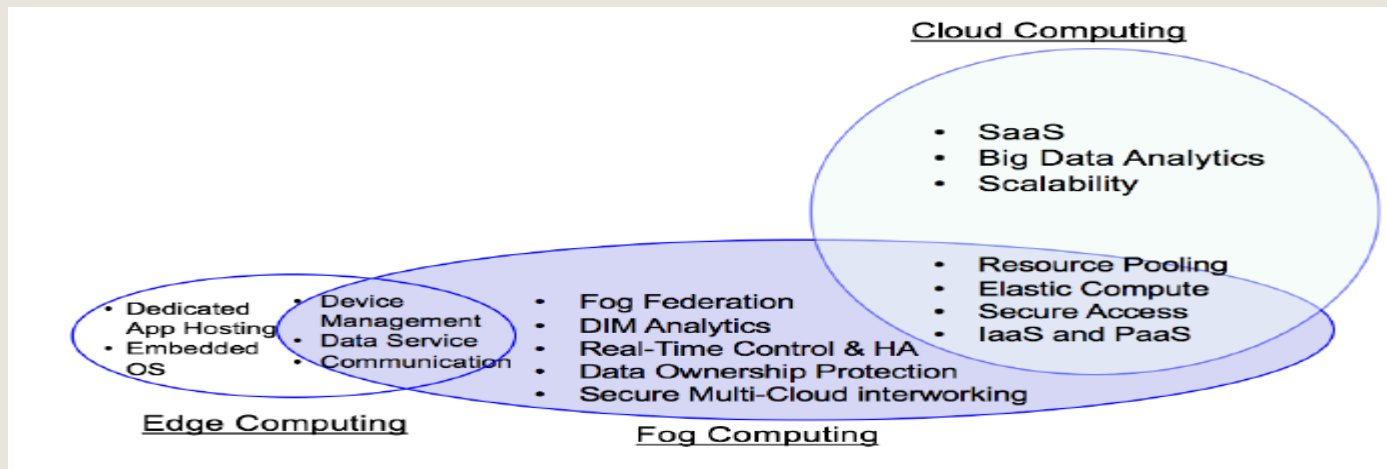

Source[15]: Fog vs Edge Computing, <https://www.nebbiolo.tech/wp-content/uploads/whitepaper-fog-vs-edge.pdf>

ComputationWorld 2018 Conference February 18, 2018, Barcelona





# 1. Introduction



- **Edge-oriented computing- visions**
- **Examples (cont'd)**
- **Industry (4.0) vision on Fog and IoT**
  - Industrial IoT and Industry 4.0 → need for extensive adoption of advanced IT features across **multiple Industry verticals**
  - **IT and Operational Technology (OT) convergence is aimed**
  - The next step : deployment of Cloud-like resources at the edge and within the Industrial Operational domain.
  - **Fog Computing**
    - Merges CC features with rt and safety OT features (efficiency, flexibility and resource management)
    - Applies resource virtualisation, rt and nrt computing, modern application management, data interoperability middleware, storage, analytics, advanced networking and security
  - **Complementary technologies**
    - ***Time-Triggered Technologies***
      - precise time distribution, time-sensitive networking and computing resource allocation (standardized as *IEEE Time Sensitive Networking TSN*).
      - **TSN is a key element of Industry 4.0 and a necessary component of FC in industrial environment**
        - It enables the convergence of Industrial wired protocols towards a unified standard.



# 1. Introduction



- **Edge oriented computing- visions**
- **Examples (cont'd)**
- **Industry 4.0 vision on Fog and IoT (cont'd)**

**ERP** - Enterprise Resource Planning  
**MES** - Manufacturing execution systems  
**SCADA** - supervisory control and data acquisition  
**AGV**- automatic guided vehicle  
**PLC** -Programmable Logic Controllers

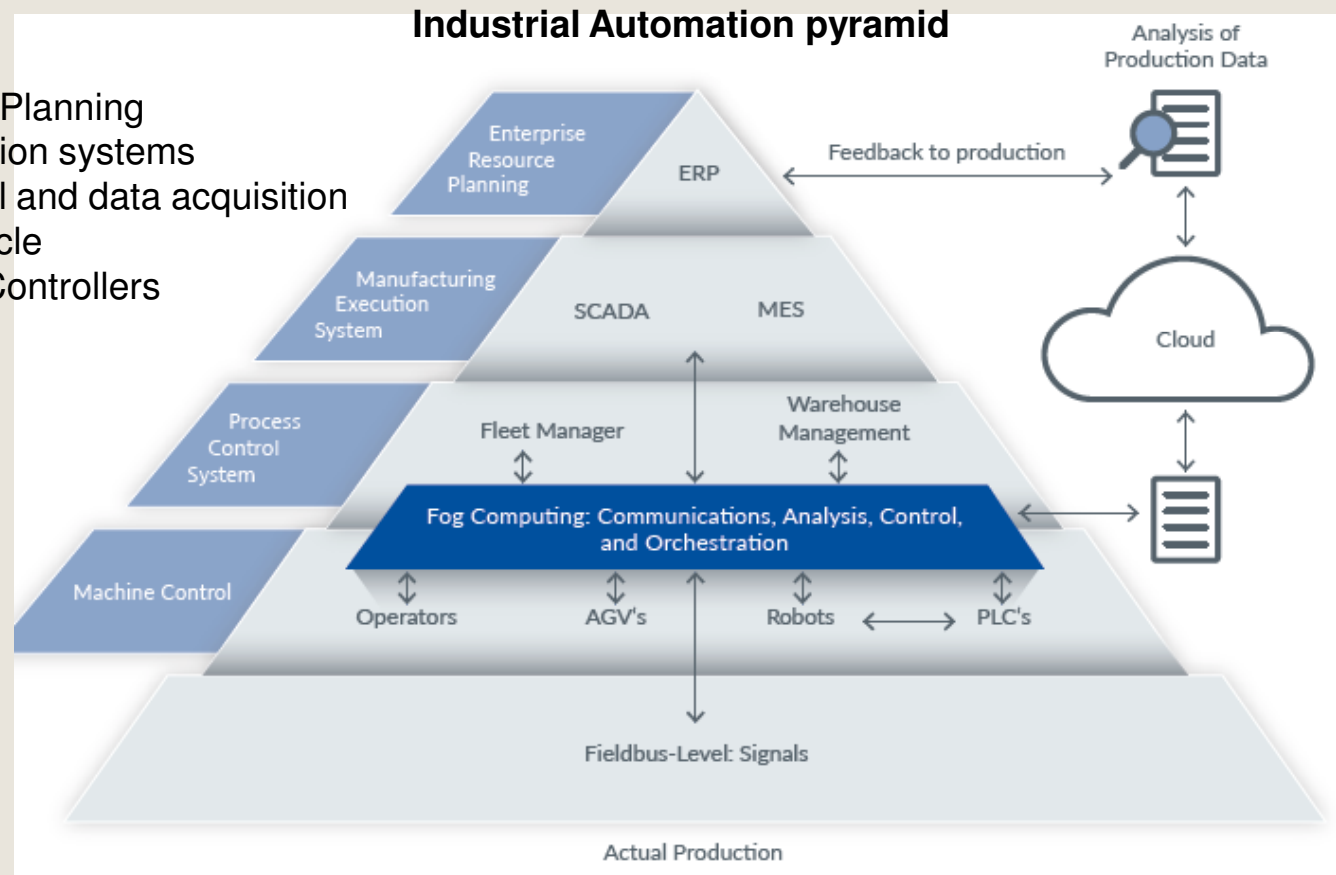

Source [16]: *Fog Computing: Keystone of Industrial IoT and Industry 4.0*,  
<https://www.fogworldcongress.com/conference/agenda/fog-computing-keystone-industry-40>

ComputationWorld 2018 Conference February 18, 2018, Barcelona

- **Edge-oriented computing- visions**
- **Examples (cont'd)**
- **Industry 4.0 vision on Fog and IoT (cont'd)**

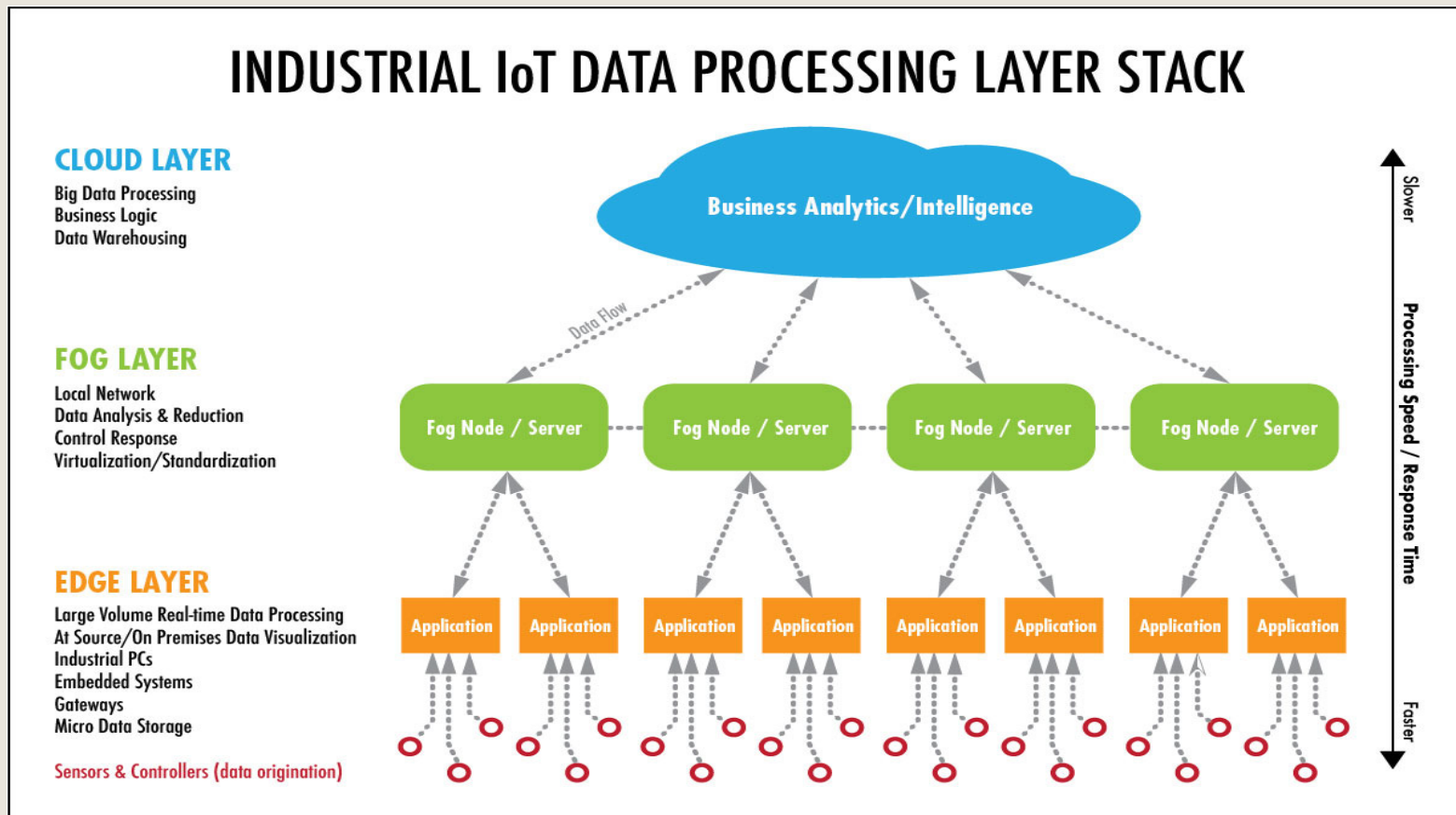

Source [17]: Cloud, Fog and Edge Computing – What’s the Difference?  
<https://www.winsystems.com/cloud-fog-and-edge-computing-whats-the-difference/>

ComputationWorld 2018 Conference February 18, 2018, Barcelona



# 1. Introduction



- **Edge-oriented computing- visions**
- Examples (cont'd)
- **Industry 4.0 vision on Fog and IoT (cont'd)**
- **FC and EC are similar:** both bring intelligence and processing closer to the data source
  - **IIoT sees difference FC/EC: where the location of intelligence and compute power is placed.**
    - **FC places intelligence at the LAN.** This architecture transmits data from endpoints to a gateway, where it is then transmitted to processing elements (in LAN) and then results are returned
    - EC places intelligence and processing power in devices such as embedded automation controllers
- **The IIoT architecture :** edge, fog and cloud architectural layers (EC and FC) complement each other
  - FC uses a centralized system that interacts with industrial gateways and embedded computer systems on a LAN
  - whereas EC performs much of the processing on embedded computing platforms directly interfacing to sensors and controllers
- **Note: this distinction is still not always clear (organizations can adopt various solutions in their approach to data processing)**

*Source [ 17]:Cloud, Fog and Edge Computing – What's the Difference?*

<https://www.winsystems.com/cloud-fog-and-edge-computing-whats-the-difference/>

ComputationWorld 2018 Conference February 18, 2018, Barcelona

## Relationship between Fog Computing, Cloudlet, and MEC

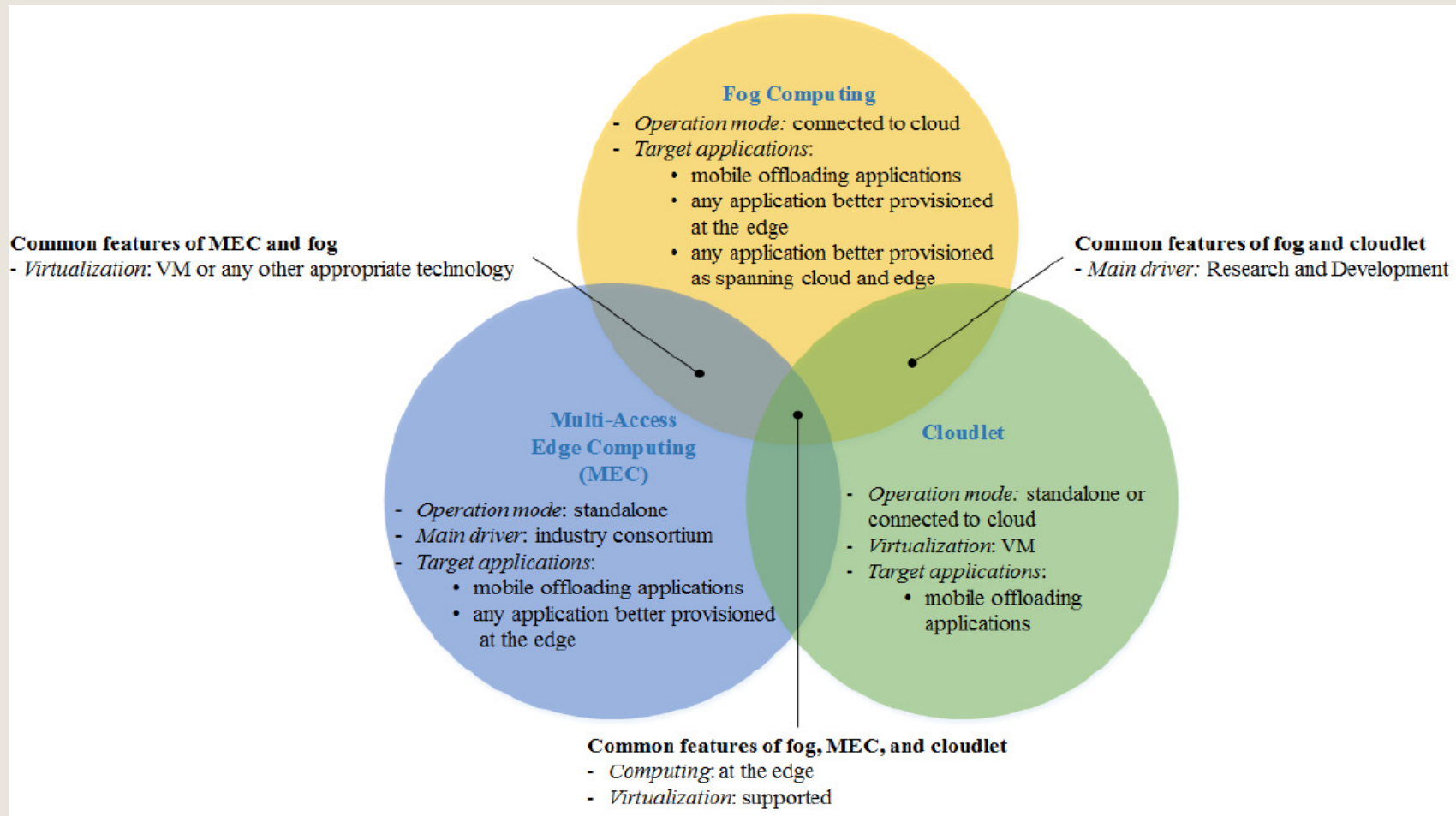

Source [18]: C. Mouradian, et.al., A Comprehensive Survey on Fog Computing: State-of-the-art and Research Challenges, IEEE Communications Surveys & Tutorials, 2017

ComputationWorld 2018 Conference February 18, 2018, Barcelona

- Computation domain of Cloud, Fog, Edge, Mobile Cloud and MEC

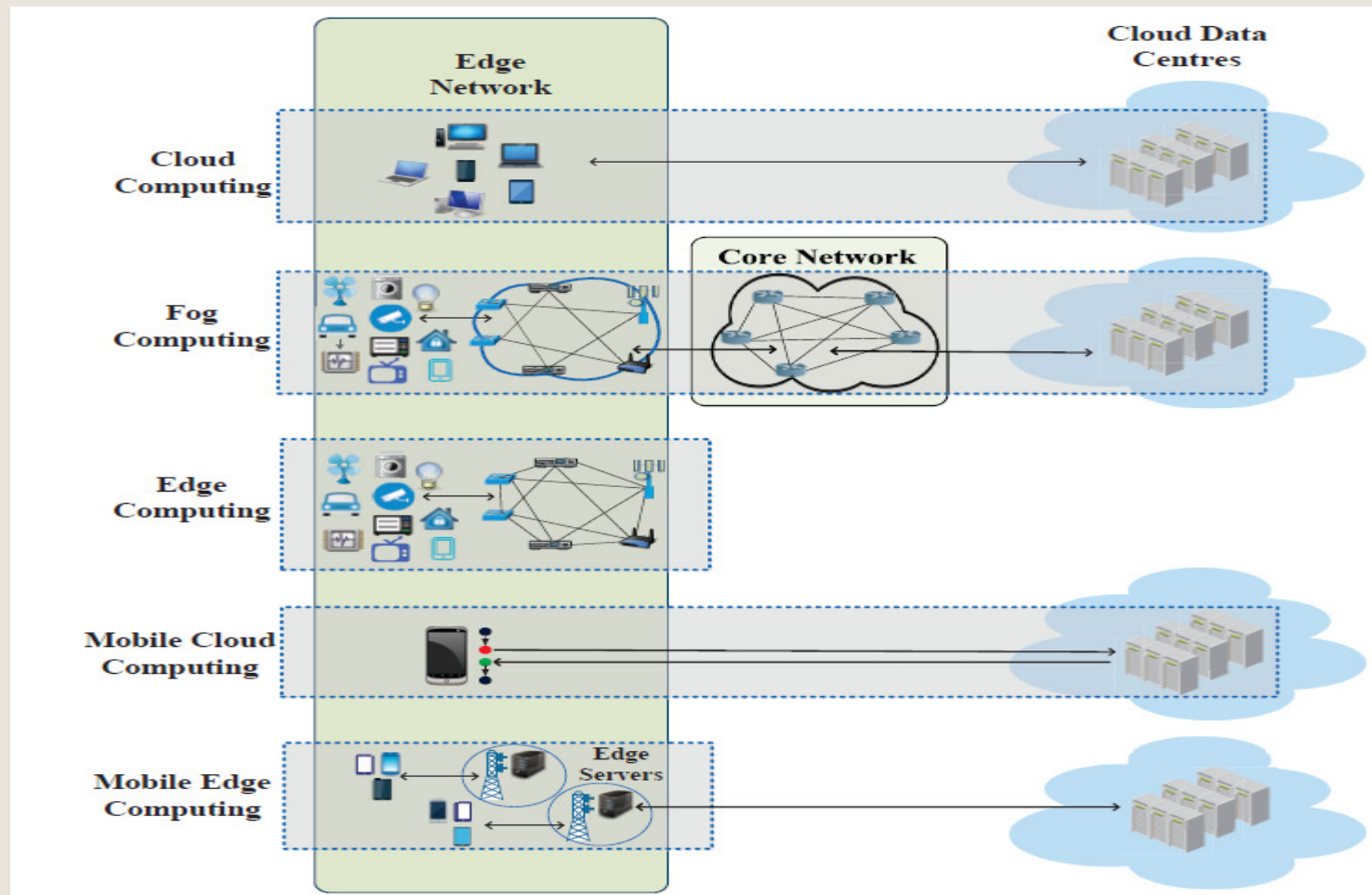

Source [19]: R.Mahmud and R.Buyya, *Fog Computing: A Taxonomy, Survey and Future Directions*, arXiv:1611.05539v3 [cs.DC] 24 Nov 2016



# 1. Introduction



- **Applications and use cases examples**
- **Fog Computing Applications and use cases**
  
- **IoT:**
  - Industrial IoT, automation
  - Smart Agriculture
  - Sustainable Smart Cities:
    - Transportation (safety, traffic mgmt., information and entertaining)
    - Health and Well-Being
    - Waste Management
    - Water Management
    - Greenhouse Gases Control
    - Power Grid
    - Retail Store Automation
    - Smart buildings, home
    - Safety and emergency applications
- Mobile Network / Radio Access Network
- Long-Reach Passive Optical Network / Power Line Communication
- Internet of vehicles (all applications), Vehicle to Grid systems
- Content Distribution Network



# 1. Introduction



- **Applications and use cases examples** (cont'd)
- **MEC applications and use cases**
  - **Subscribers:** better and more mobile broadband, and new services
    - Throughput guidance (video optimization)
      - User and network analytics
      - LTE coverage extender
    - Edge video orchestration: Augmented reality
    - User engagement, Indoor navigation
  - **Enterprises and corporates:** extends traditional footprint
    - Local breakout to enterprise network
    - Private LTE (local EPC, HSS, IMS)
    - Footfall analysis, Mission critical group communications, Video surveillance
    - Object tracking, Local content
  - **Internet of Things and Verticals:** new network-based service innovation
    - Edge video and audio analytics
    - IoT gateway
    - Deployable LTE system (network in a box)
    - Mission critical group communications
    - Car-to-car and car-to-roadside communications



- Fog/Edge (FC) use cases examples

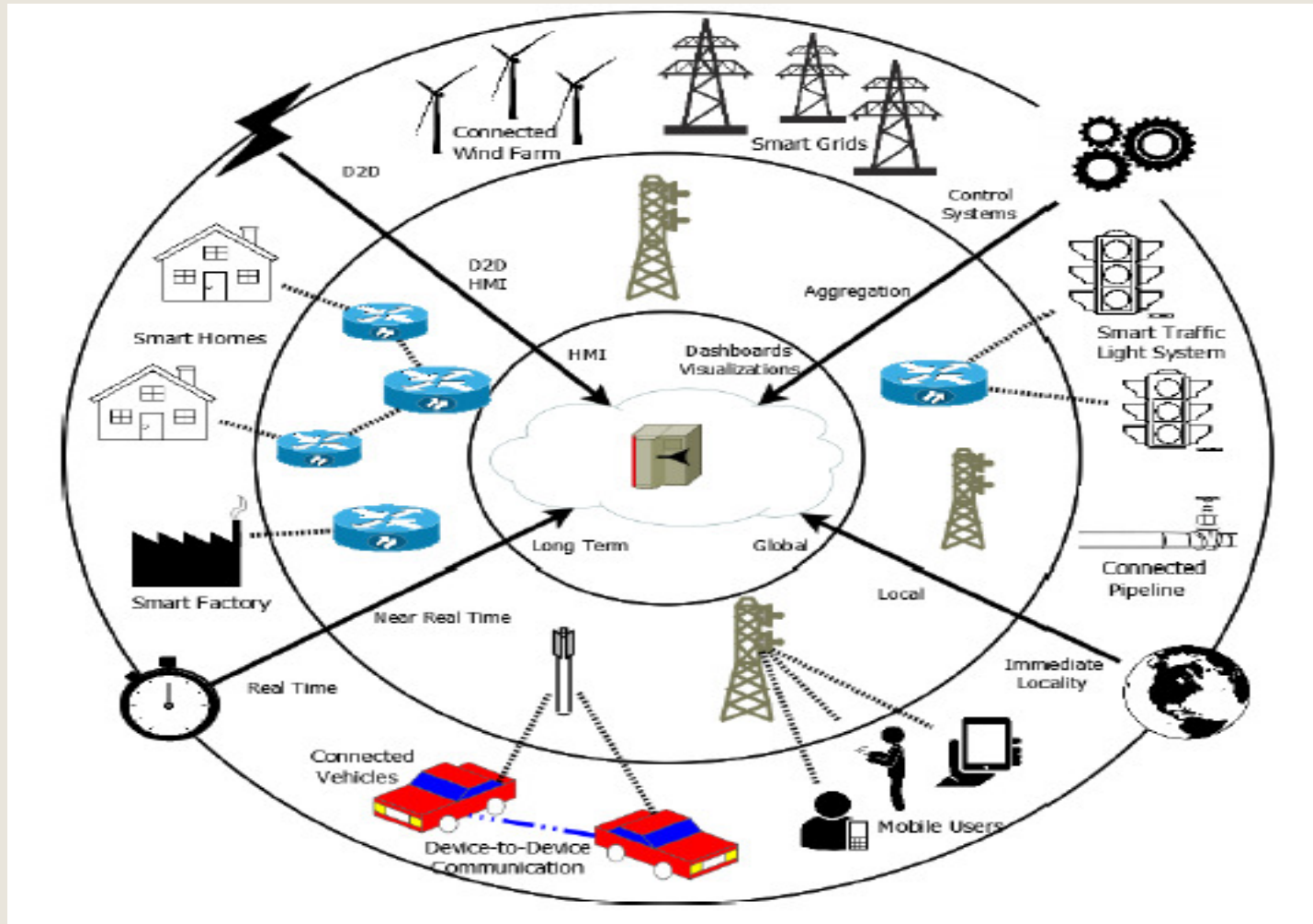

Source [20]: A.V. Dastjerdi, et.al., "Fog Computing: Principles, Architectures, and Applications", 2016, Book Chapter in Internet of Things: Principles and Paradigms, <http://arxiv.org/abs/1601.02752>

ComputationWorld 2018 Conference February 18, 2018, Barcelona



# CONTENTS



1. Introduction
2.  Multi-access Edge Computing
3. Fog Computing
4. Cloudlets
5. Convergence and open research topics
6. Conclusions



## 2. Multi-access Edge Computing



- **Why MEC?**
  - **Initially MEC provided IT and cloud-computing capabilities within the RAN in close proximity to mobile subscribers [5-7],** to improve services and applications responsiveness from the edge
  - **Main standardization actors:** ETSI (2014), 3GPP, ITU-T
  - Operators and industry are interested: DOCOMO, Vodafone, TELECOM Italia) IBM, Nokia, Huawei, Intel, etc.
  - RAN edge can offer **ultra-low latency, high-bandwidth and direct access to real-time RAN information**
    - (information like subscriber location, cell load, channels load, etc.) useful for applications and services to offer **context-related services**
  - **Operators can open the RAN edge to third-party partners**
  - **Features as proximity, context, agility and speed** → novel opportunities for Mobile Network Operators (MNOs), SP/CP, **Over the Top (OTT)** players and **Independent Software Vendors (ISVs)**

### MEC Taxonomy

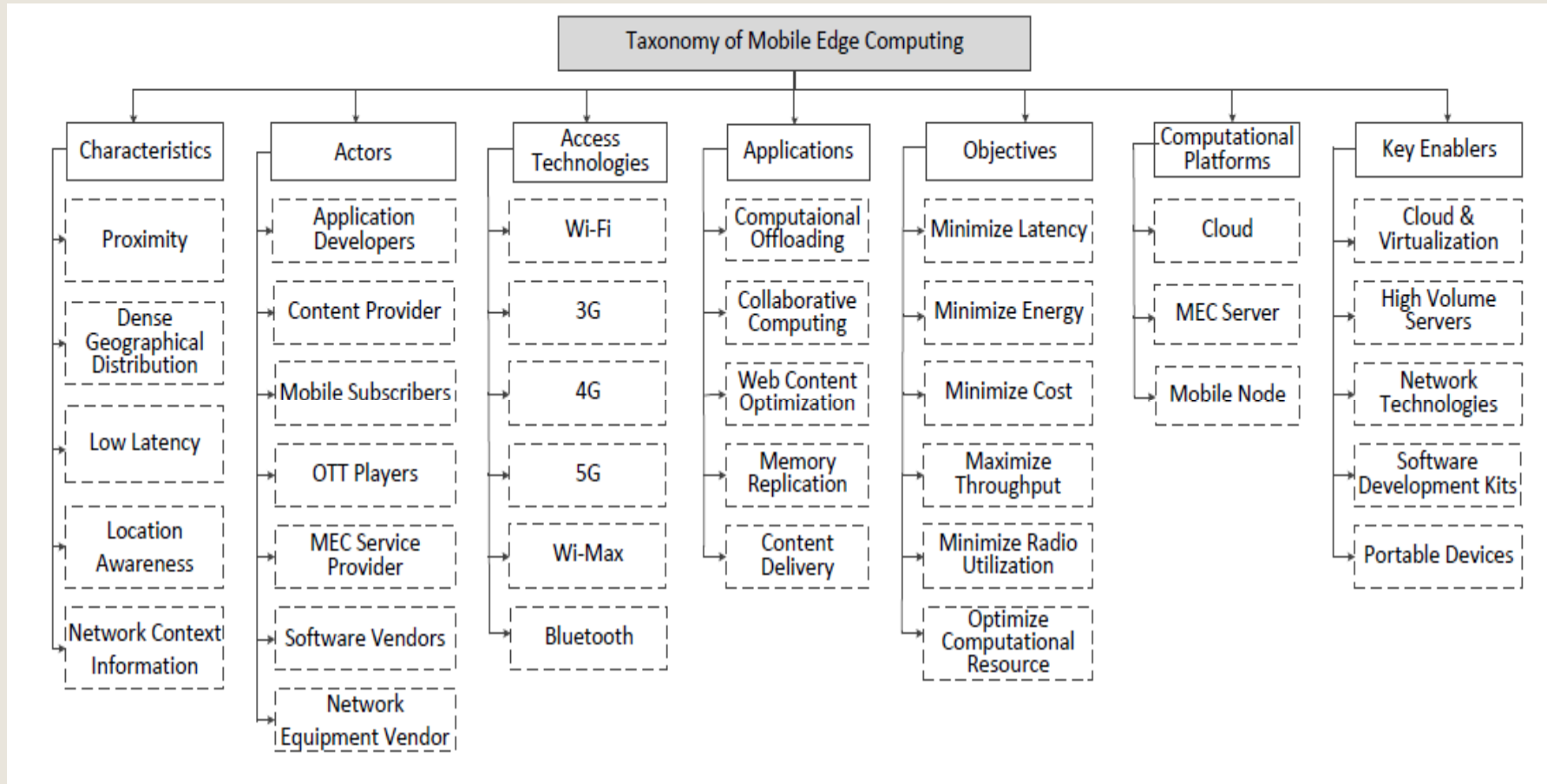

Source [21]: A. Ahmed, E. Ahmed, "A Survey on Mobile Edge Computing"  
 IEEE, Int'l Conf. on Intelligent System and Control ISCO 2016  
<https://www.researchgate.net/publication/285765997>

ComputationWorld 2018 Conference February 18, 2018, Barcelona



## 2. Multi-access Edge Computing



- **MEC Use Cases examples (content- oriented)**
  - **Consumer-oriented services (offloading)**
    - Augmented/assisted/virtual reality
    - Face recognition
    - Web accelerated browsing
    - Image/video editing
    - Gaming, Remote desktop
    - RAN-aware Content Optimization and delivery
    - Distributed Content and DNS Caching
  - **Network performance and QoE improvement services**
    - Traffic monitoring/shaping
    - Content caching
    - Radio/backhaul optimization
    - Application-aware cell performance optimization
  - **Operator and third party services**
    - Internet of Things (IoT)
    - Vehicular communications
    - Big Data
    - Video Analytics

Source[ 22]: [https://portal.etsi.org/Portals/0/TBpages/MEC/Docs/Mobile-edge\\_Computing\\_-\\_Introductory\\_Technical\\_White\\_Paper\\_V1%2018-09-14.pdf](https://portal.etsi.org/Portals/0/TBpages/MEC/Docs/Mobile-edge_Computing_-_Introductory_Technical_White_Paper_V1%2018-09-14.pdf)

ComputationWorld 2018 Conference February 18, 2018, Barcelona

- **MEC Use Cases examples (content- oriented)**

- **RAN-aware Content Optimization**

- The application exposes accurate cell and subscriber radio interface information (cell load, link quality) to the **content optimizer**, enabling **dynamic content optimization**, improving QoE, network efficiency
    - **Dynamic content optimization** enhances video delivery through reduced stalling, reduced time-to-start and ‘best’ video quality.

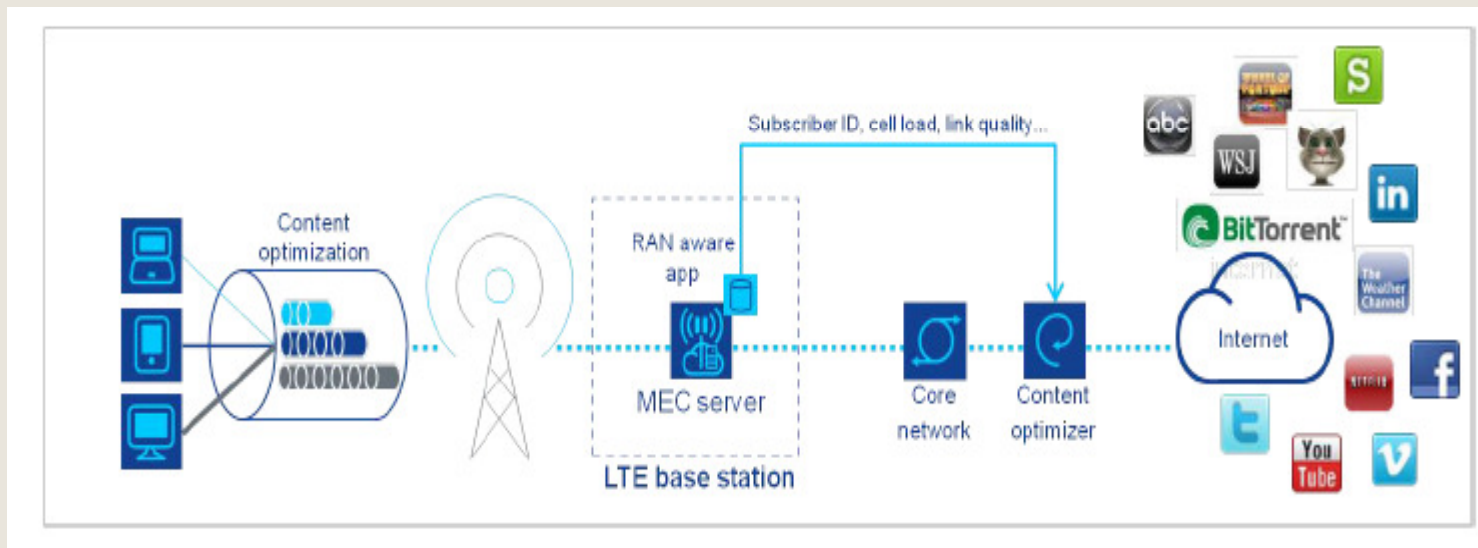

Source[5]: Patel, *Mobile-Edge Computing – Introductory Technical White Paper*  
[https://portal.etsi.org/Portals/0/TBpages/MEC/Docs/Mobile-edge\\_Computing\\_-\\_Introductory\\_Technical\\_White\\_Paper\\_V1%2018-09-14.pdf](https://portal.etsi.org/Portals/0/TBpages/MEC/Docs/Mobile-edge_Computing_-_Introductory_Technical_White_Paper_V1%2018-09-14.pdf)

ComputationWorld 2018 Conference February 18, 2018, Barcelona

- **MEC Use Cases examples**
- Internet of Things (IoT)
  - IoT generates additional messaging on telecoms networks, and requires GWs to aggregate the messages and ensure security and low latency
  - Required: real time capability; grouping of sensors and devices is needed for efficient service
  - IoT devices often have low capabilities (processor, storage capacity) → need to aggregate various IoT messages connected through the mobile network close to the devices
  - This also provides an analytics processing capability and a low latency response time.

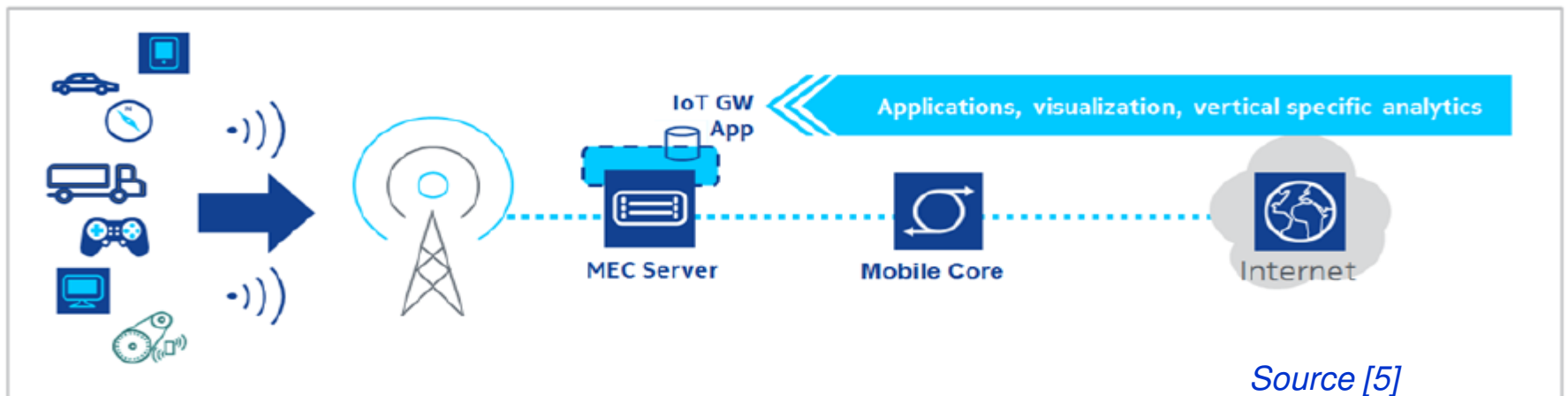

- **Possible Deployment Scenarios (ETSI)**
  - The **MEC server** can be deployed in several variants
  - Note: the multi-technology (LTE/3G) cell aggregation site can be indoor or outdoor

MEC at the LTE macro base station (eNB) site

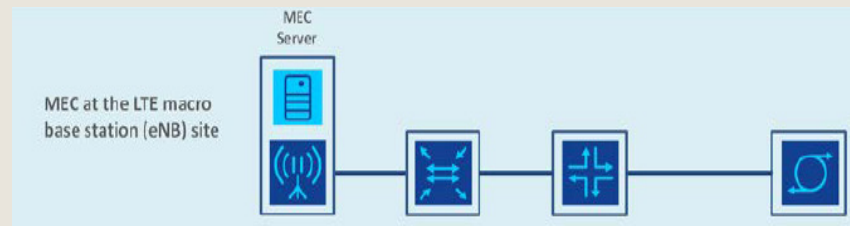

MEC at the multi-technology (3G/LTE) cell aggregation site

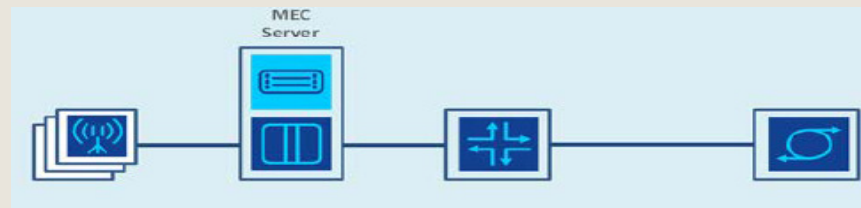

MEC at the 3G Radio Network Controller (RNC) site

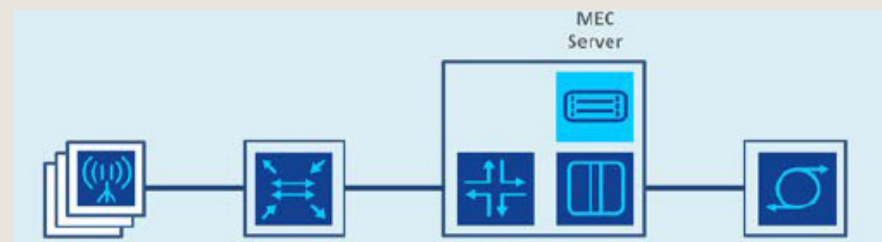

Source[5]: [https://portal.etsi.org/Portals/0/TBpages/MEC/Docs/Mobile-edge\\_Computing\\_-\\_Introductory\\_Technical\\_White\\_Paper\\_V1%2018-09-14.pdf](https://portal.etsi.org/Portals/0/TBpages/MEC/Docs/Mobile-edge_Computing_-_Introductory_Technical_White_Paper_V1%2018-09-14.pdf)  
 Mobile-Edge Computing – Introductory Technical White Paper  
 ComputationWorld 2018 Conference February 18, 2018, Barcelona





## 2. Multi-access Edge Computing



- **MEC Architecture (main source: ETSI)**
  - MEC → **distributed computing environment** : applications, services and content store/ processes - in close proximity to mobile users.
  - Applications **can benefit from rt radio and network information** and can offer a personalized and contextualized experience to the mobile subscriber.
  - The **mobile-broadband experience is more responsive** and opens up new monetization opportunities. This creates an ecosystem where new services are developed in and around the BS
  - **Key element : (MEC) IT application server** which is integrated in RAN (as in the slide above)
    - **The MEC server provides computing resources, storage capacity, connectivity, and access to user traffic and radio and network information**

*Source [7]: "Mobile edge computing (MEC); Framework and reference architecture," ETSI, Sophia Antipolis, France, Mar. 2016. [Online]. Available:*

*[http://www.etsi.org/deliver/etsi\\_gs/MEC/001\\_099/003/01.01.01\\_60/gs\\_MEC003v010101p.pdf](http://www.etsi.org/deliver/etsi_gs/MEC/001_099/003/01.01.01_60/gs_MEC003v010101p.pdf)*



## 2. Multi-access Edge Computing



- MEC Architecture (cont'd)

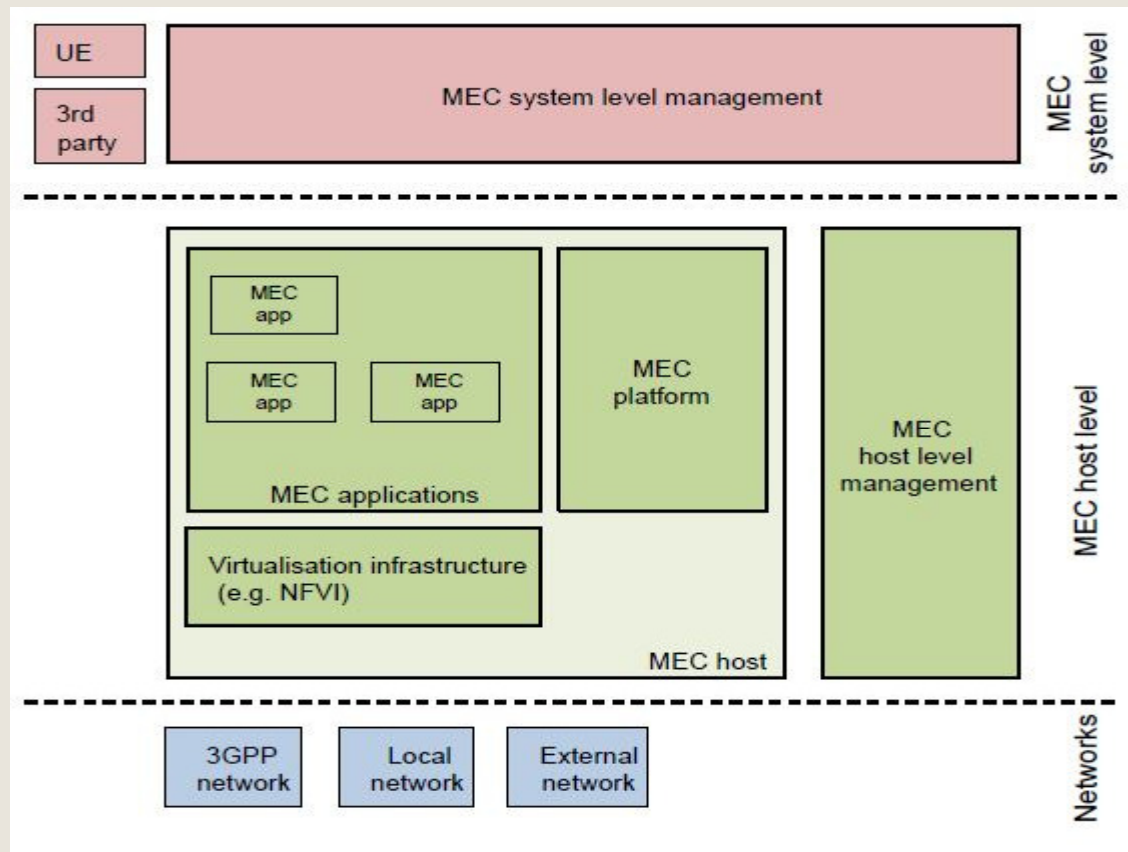

Source [7]: ETSI MEC ISG, "Mobile Edge Computing (MEC); Framework and reference architecture," ETSI, DGS MEC 003, April 2016.

[http://www.etsi.org/deliver/etsi\\_gs/MEC/001\\_099/003/01.01.01\\_60/gs\\_MEC003v010101p.pdf](http://www.etsi.org/deliver/etsi_gs/MEC/001_099/003/01.01.01_60/gs_MEC003v010101p.pdf)

ComputationWorld 2018 Conference February 18, 2018, Barcelona



## 2. Multi-access Edge Computing



- **MEC Architecture** (cont'd)
  - **(source: ETSI)**
  - **Network level entities** comprising connectivity to LANs, cellular networks and external networks (e.g., Internet)
    - Extending the type of the access to include non-cellular networks is a major goal of the current MEC activities (**Multi-access**)
  - **MEC host level** where the MEC host sits along with its associated management subsystem
    - The MEC hosts : platform and the virtualization infrastructure where the applications run
  - **MEC system level management has a** global view of the whole MEC system, i.e.:
    - the collection of MEC hosts
    - and the associated management subsystem



## 2. Multi-access Edge Computing



- **MEC Architecture** (cont'd)
  
- **ETSI MEC Terminology** - ETSI GS MEC 001 V1.1.1 (2016-03)
  - **ME application:** appl. instantiable on a ME host within the ME system
    - It can potentially provide or consume ME services
  
  - **ME host:** entity containing a **ME platform** and a **virtualisation** infrastructure to provide *compute, storage and network* resources to ME apps.
  
  - **ME platform:** set of functionality
    - required to run ME apps. on a specific ME host virtualization infrastructure
    - and to enable them to provide and consume ME services
    - It can provide itself a number of ME services
  
  - **ME host level management:** components handling the management of the ME specific functionality of a particular ME platform, ME host and the ME applications running on it

Source [7]:) ETSI GS MEC 003 V1.1.1 (2016-03), "Mobile Edge Computing (MEC); Framework and Reference Architecture"



## 2. Multi-access Edge Computing



- **MEC Architecture** (cont'd)
  
- ETSI MEC Terminology ETSI GS MEC 001 V1.1.1 (2016-03)
  - **ME system:** collection of ME hosts and ME management necessary to run ME apps. within an operator network or a subset of an operator network
  
  - **ME management:**
    - **system level management:** components which have the overview of the complete ME system
    - and **mobile edge host level management**
  
  - **ME service:** service provided via the ME platform either
    - by the **ME platform** itself
    - or, **by a ME application**

*Source [ 7]:) ETSI GS MEC 003 V1.1.1 (2016-03), "Mobile Edge Computing (MEC); Framework and Reference Architecture"*

### Network Function Virtualisation (NFV) Architecture (ETSI)

- **High level view of NFV framework (MEC arch. is based on this)**
- **Working domains**
- **VNF**, as the SW implementation of a NF
- **NFV Infrastructure (NFVI)** includes the PHY resources and how these can be virtualized
  - NFVI supports the execution of the VNFs.
- **NFV Management and Orchestration (NFV-MANO)**
  - orchestration and lifecycle management of physical and/or SW resources
  - NFV MANO focuses on all virtualization-specific management tasks

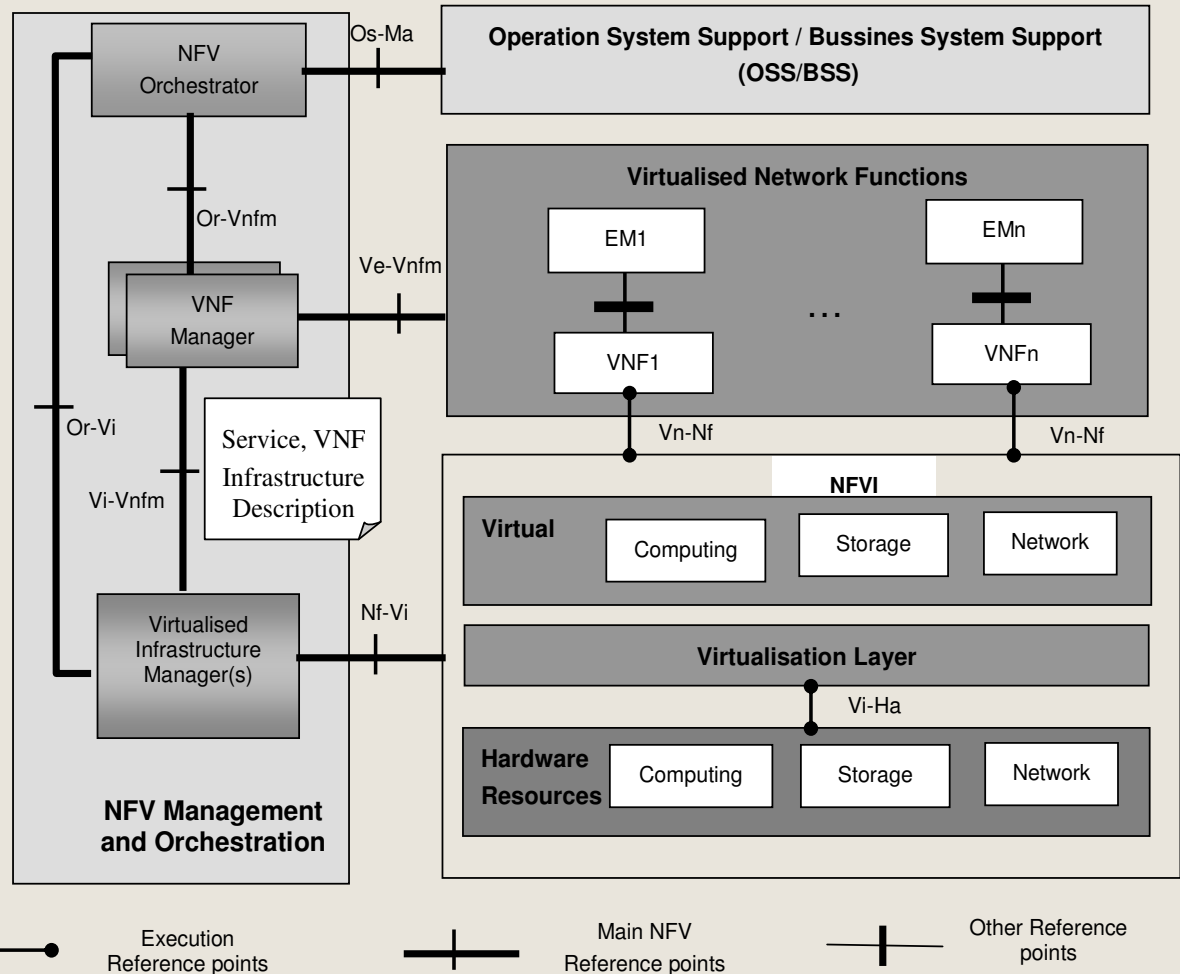

## 2. Multi-access Edge Computing

- MEC Reference Architecture -ETSI

Similar to NFV- MANO-stack

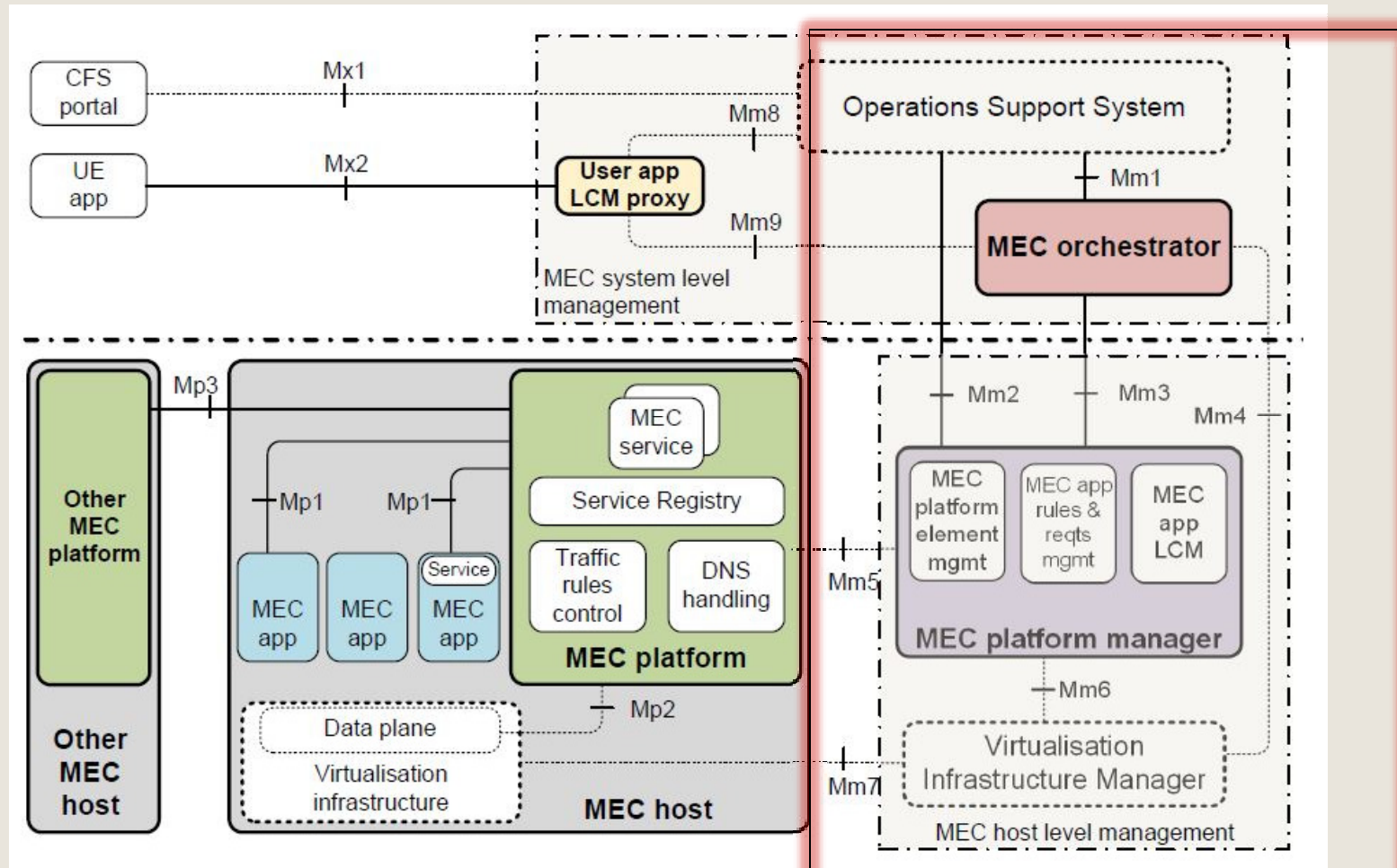

Source [ 7]:) ETSI GS MEC 003 V1.1.1 (2016-03), "Mobile Edge Computing (MEC); Framework and Reference Architecture"

ComputationWorld 2018 Conference February 18, 2018, Barcelona

- MEC Reference Architecture –ETSI- NFV implementation

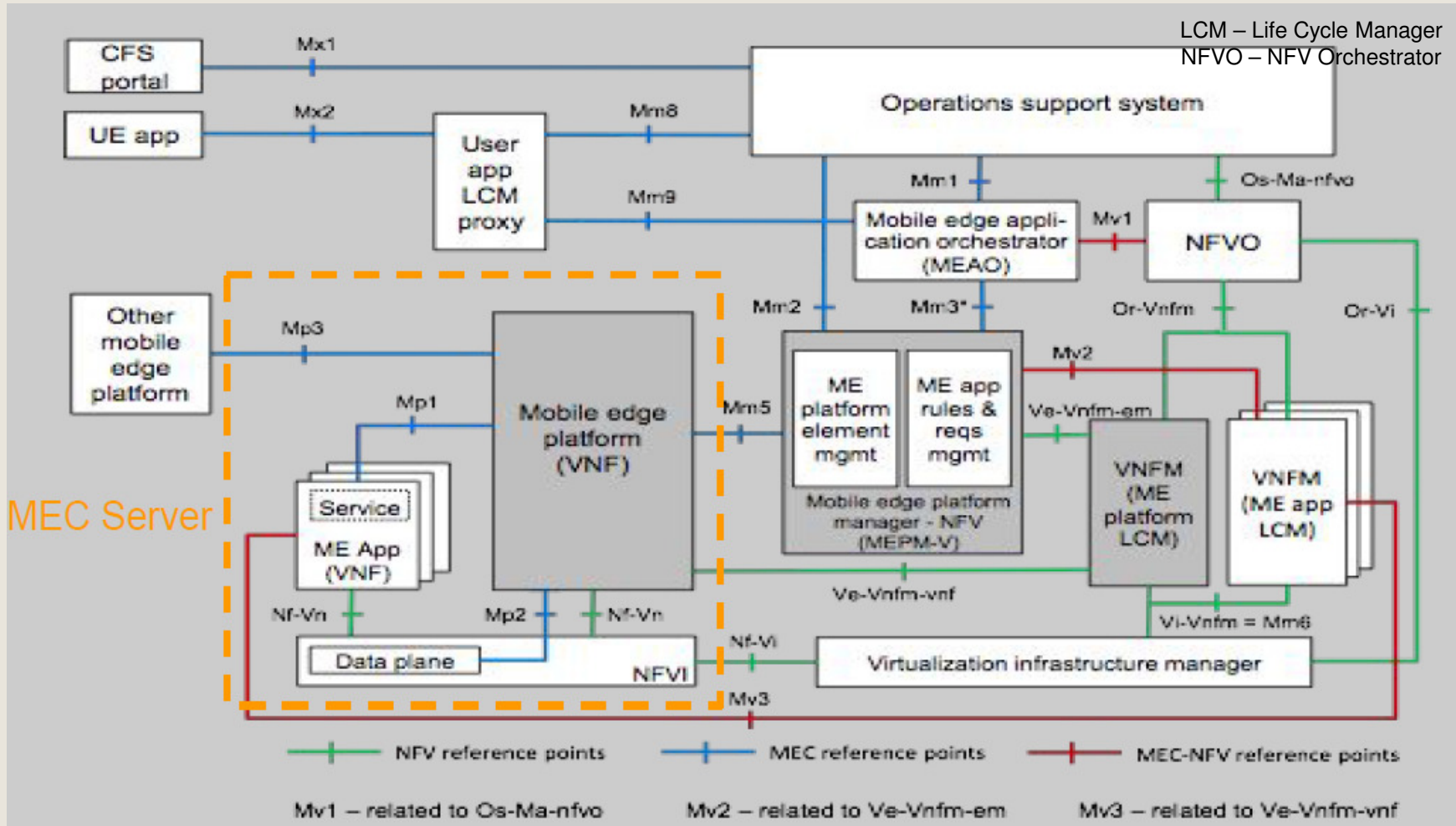

Source [ 7:): ETSI GS MEC 003 V1.1.1 (2016-03), "Mobile Edge Computing (MEC); Framework and Reference Architecture"

ComputationWorld 2018 Conference February 18, 2018, Barcelona



## 2. Multi-access Edge Computing

- MEC Platform Overview (*source: ETSI*)- NFV inspired arch

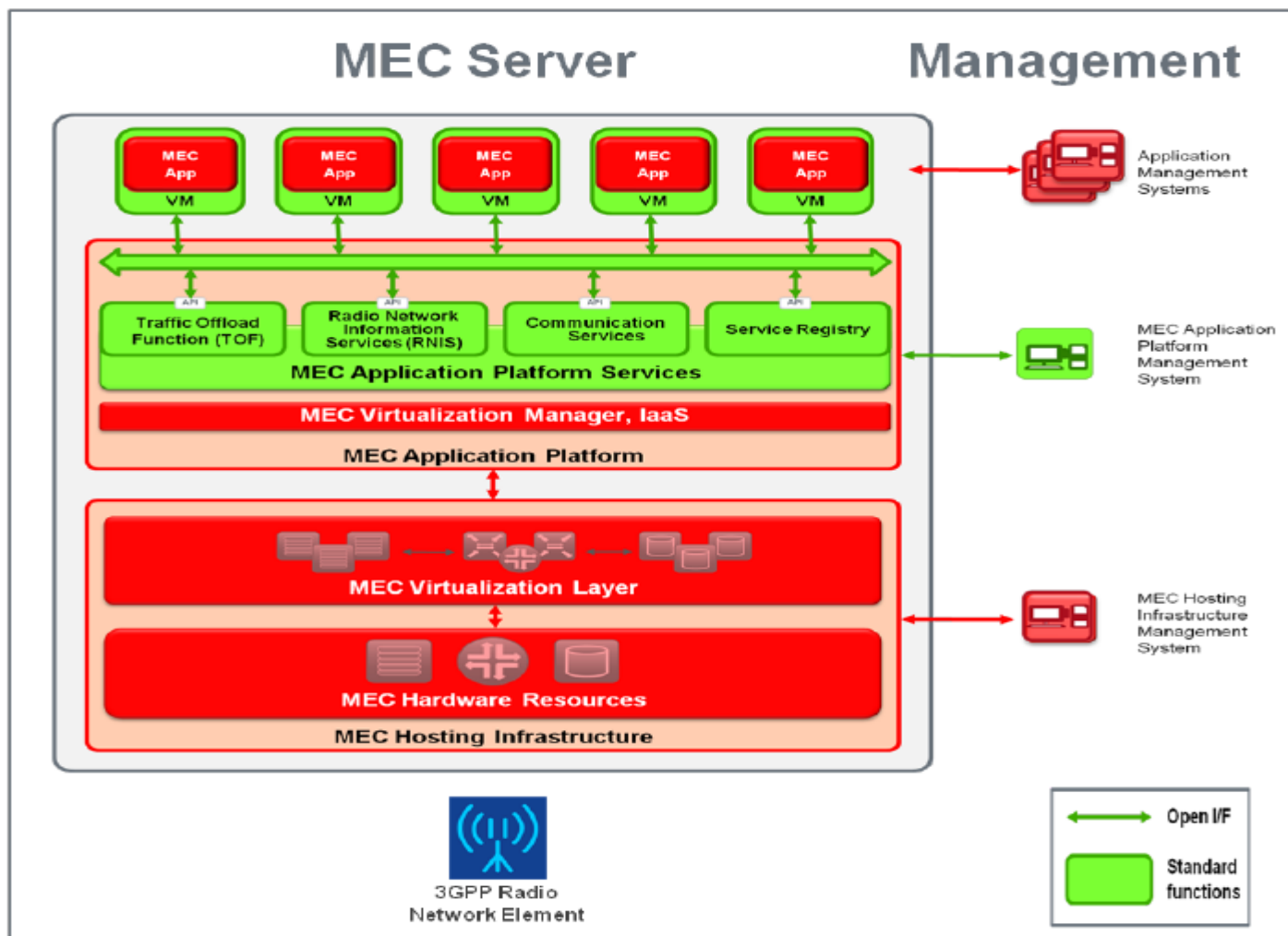



## 2. Multi-access Edge Computing



- **MEC extension** (2017)
- Name change for ETSI's MEC - **Multi-Access Edge Computing**
  - Trend: separate networks with separate requirements → to unified networks with unified requirements.
  - MEC (originally conceived to support 5G) becomes capable of solving many problems of the SPs
    - New services
    - Examples:
      - Micro-localized applications
      - Multi-access Management Services ( MAMS)
      - V2X use cases
      - network slicing
      - ..



## 2. Multi-access Edge Computing



- **Multi-access extension of MEC** ( 2017)
- **Example**
- **Multi-access Management Services ( MAMS)**

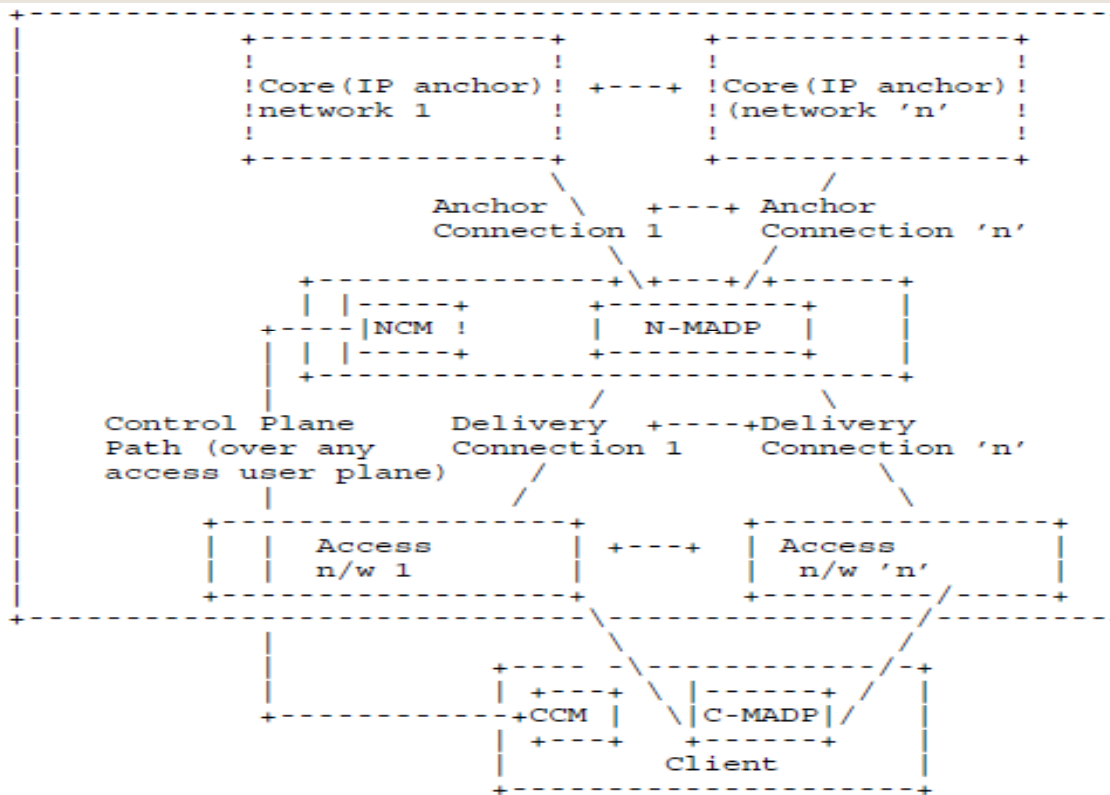

**Scenario of a client served by multiple (n) networks.**

CPI  
Network Connection Manager (NCM)  
Client Connection Manager (CCM)

DPI  
Network Multi Access Data Proxy (N-MADP)  
Client Multi Access Data Proxy (C-MADP)

*Source [23]: IETF, Kanugovi et. al., Multiple Access Management Services draft-kanugovi-intarea-mams-framework-00 July 2017*

ComputationWorld 2018 Conference February 18, 2018, Barcelona



## 2. Multi-access Edge Computing



- **Computation offloading problem in MEC**
  - A **decision on the computation offloading** to the MEC ( to determine whether the offloading is appropriate for the UE )
    - in terms of energy consumption
    - and/or execution delay
    - ....
  - If the **computation is offloaded: efficient allocation of the computing resources** is needed within the MEC in order to
    - minimize execution delay
    - balance load of both computing resources and communication links
  - **Mobility management** for the applications offloaded to the MEC
    - **guaranteeing service continuity** if the UEs exploit the MEC roams throughout the network-strong requirement

*Source [24 ]: P.Mach, Z.Becvar, Mobile Edge Computing: A Survey on Architecture and Computation Offloading, arXiv:1702.05309v2 [cs.IT], 13 Mar 2017*

- **Computation offloading problem in MEC ( offloading modes)**
  - The decision on computation offloading may select :
    - **Local execution** – all computation is done locally at the UE
      - no offloading to the MEC ( e.g., unavailability of the MEC computation resources or too high cost)
    - **Full offloading** – all computation is offloaded and processed by the MEC
    - **Partial offloading** - a part of the computation is processed locally and other part is offloaded to the MEC

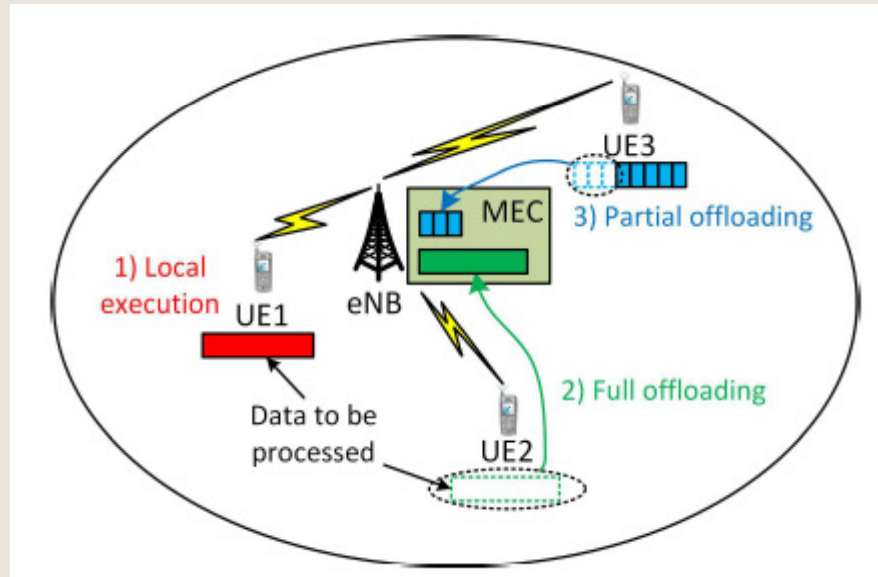

Source [24]: P.Mach, Z.Becvar, *Mobile Edge Computing: A Survey on Architecture and Computation Offloading*, arXiv:1702.05309v2 [cs.IT], 13 Mar 2017

ComputationWorld 2018 Conference February 18, 2018, Barcelona

### ■ Mobility management in MEC and service continuity

#### ■ Options

- **a. applicable for low mobility** (e.g. within a room) UEs ( i.e., no handover between Base Stations) : adaptation of the transmission power of the evolved Node B or Small Cell Node B (eNB/SCeNB) during the time when the offloaded application is processed by the MEC
- **b. UE performs handover** to the new serving eNB/SCeNB
  - *Virtual Machine (VM) migration* from the current computing node(s) to another, more suitable, or
  - selection of a new comm. path between the UE and the computing node

VM migration principle [25]

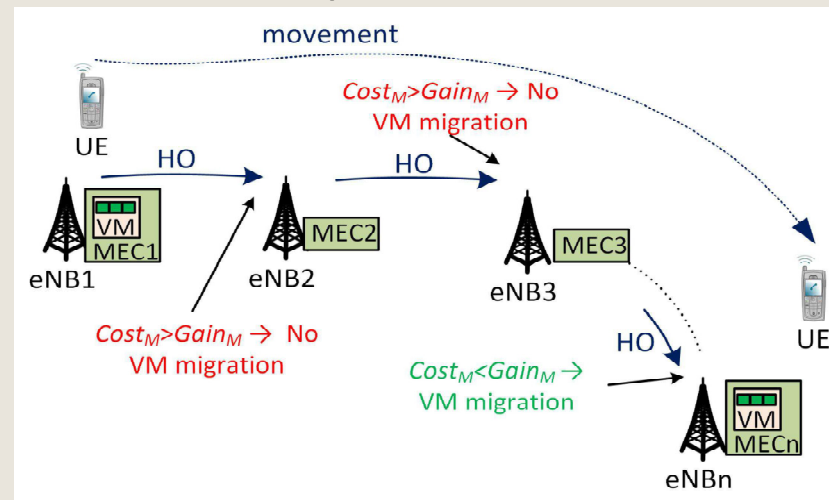

Source [25] : A. Ksentini, T. Taleb, and M. Chen, "A Markov Decision Process-based Service Migration Procedure for Follow Me Cloud", IEEE International Conference on Communications (ICC), 1350-54, 2014

ComputationWorld 2018 Conference February 18, 2018, Barcelona



# CONTENTS

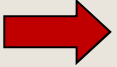

1. Introduction
2. Multi-access Edge Computing
3.  Fog Computing
4. Cloudlets
5. Convergence and Open research topics
6. Conclusions



## 3. Fog Computing



- **Fog Computing (FC) Introduction**
- FC performs/offers -*near the end-user*
  - *Computing, storage, communication, management (including network)*
- **OpenFog Consortium (2015) definition**
  - *Source: <http://www.openfogconsortium.org/resources/#definition-of-fog-computing>*
  - “**Fog computing is a system-level horizontal architecture** that distributes resources and services of computing, storage, control and networking **anywhere along the continuum from Cloud to Things**”
  - **FC Node (FCN)** physical and logical network element that implements FC services. ( ~ analogous to a server in CC)
- **FC main concepts :**
  - extends **cloud functions** into Fog domain at the edge in a **single continuum**.
  - applies across different types of domains, i.e., IoT verticals
  - enables **secure M&C** of multiple fog domain instances (**Fog Federation**), comprising of edge devices, computes, networking, storage, and services in a distributed and consistent manner.
  - enables **E2E security** from the **cloud to the edge devices** across IT domain, DMZ domains, and the OT domains.
  - brings the **data collection, processing and analysis closer to the data sources** at the edge enabling both edge and fog analytics



- Fog Computing general architecture

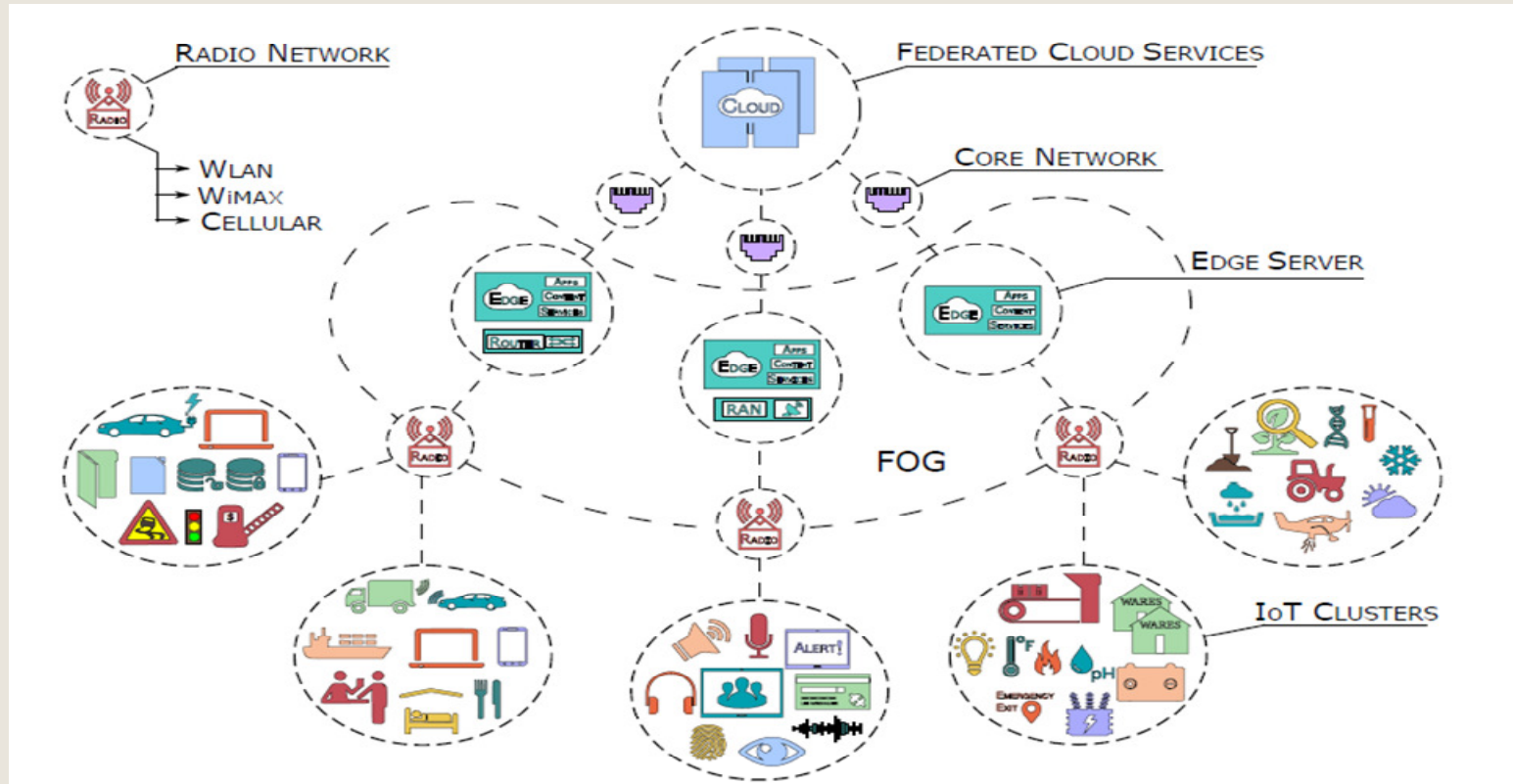

Source[26]: A.Munir, et.al., "IFCIoT: Integrated Fog Cloud IoT Architectural Paradigm for Future Internet of Things", arXiv:1701.08474v1 [cs.DC] 30 Jan 2017

- Fog Computing hierarchical infrastructure

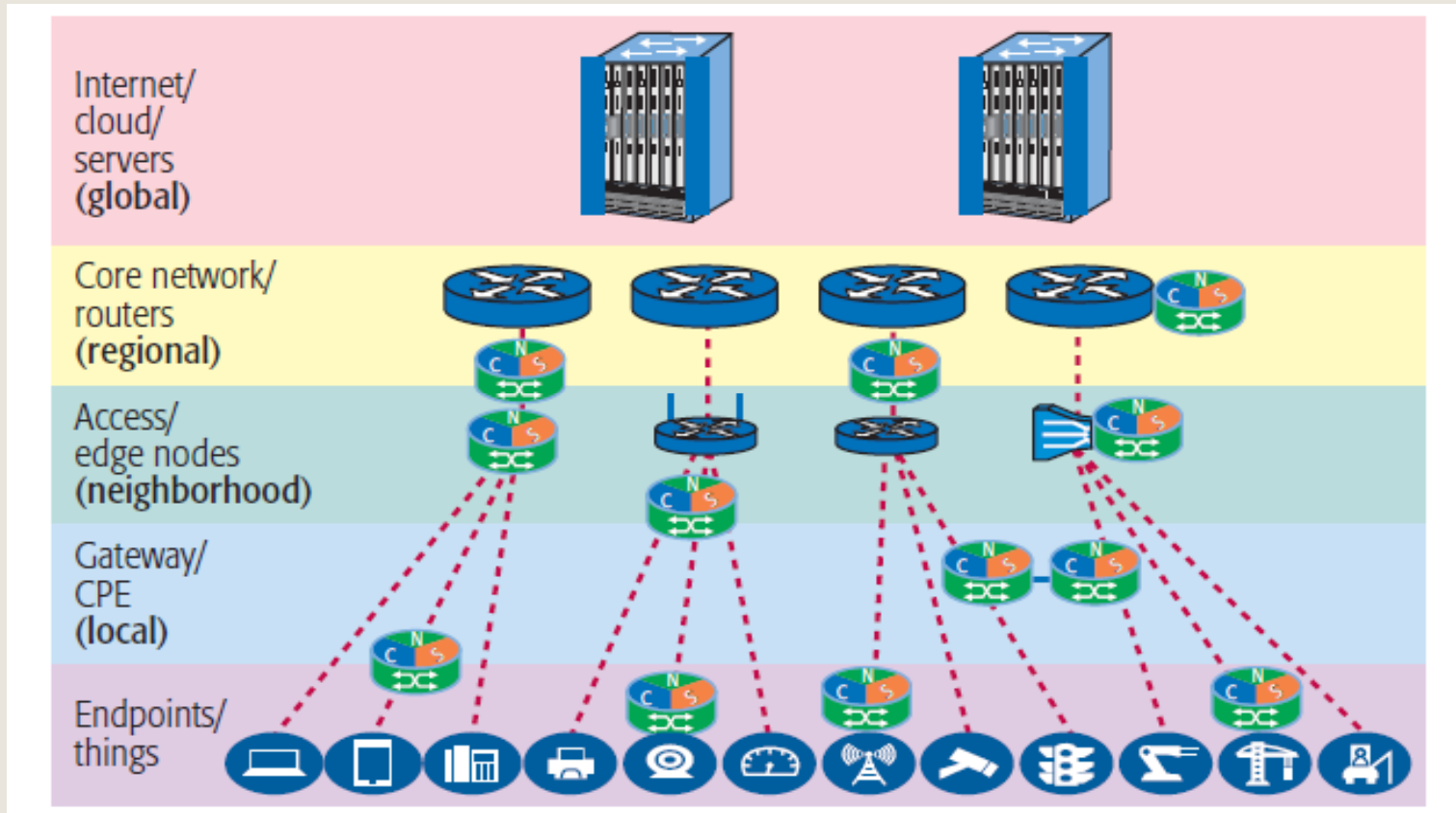

Source [27]: C.C. Byers, *Architectural Imperatives for Fog Computing: Use Cases, Requirements, and Architectural Techniques for Fog-Enabled IoT Networks*, IEEE Communications Magazine, August 2017, pp.14-20



# 3. Fog Computing



## Fog Computing Taxonomy

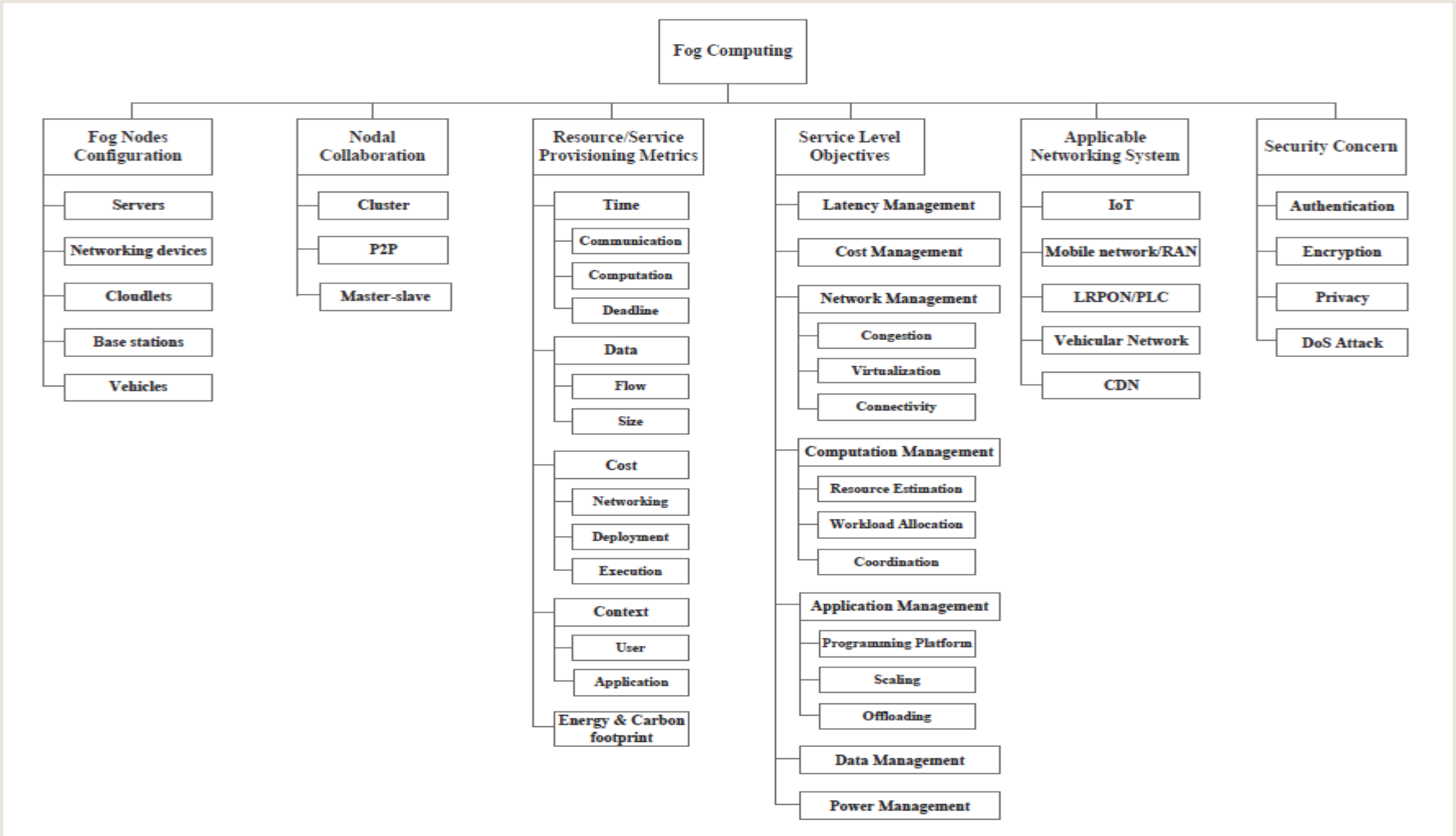

Source [19]: Redowan Mahmud and Rajkumar Buyya, *Fog Computing: A Taxonomy, Survey and Future Directions*, arXiv:1611.05539v3 [cs.DC] 24 Nov 2016

ComputationWorld 2018 Conference February 18, 2018, Barcelona



# 3. Fog Computing



- **Comparison Cloud Computing versus Fog Computing**
- **FC provides**
  - **light-weight cloud-like facility** close of mobile users
  - users with a **direct short-fat** connection versus **long-thin** mobile cloud connection
  - customized and engaged **location-aware** services
- **FC is still new and there is a lack of a standardized definition**
- **Comparison between Fog (FC) and Conventional Cloud Computing**

	<b>Fog Computing</b>	<b>Cloud Computing</b>
Target User	Mobile users	General Internet users.
Service Type	Limited localized information services related to specific deployment locations	Global information collected from world-wide
Hardware	Limited storage, compute power and wireless interface	Ample and scalable storage space and compute power
Distance to Users	In the physical proximity and communicate through single-hop wireless connection	Faraway from users and communicate through IP networks
Working Environment	Outdoor (streets, parklands, <i>etc.</i> ) or indoor (restaurants, shopping malls, <i>etc.</i> )	Warehouse-size building with air conditioning systems
Deployment	Centralized or distributed in regional areas by local business (local telecommunication vendor, shopping mall retailer, <i>etc.</i> )	Centralized and maintained by Amazon, Google, <i>etc.</i>

Source [28] T H. Luan et.; al. , "Fog Computing: Focusing on Mobile Users at the Edge" arXiv:1502.01815v3 [cs.NI] 30 Mar 2016



## 3. Fog Computing



- **Comparison Cloud Computing versus Fog Computing (cont'd)**
  - **Comparisons on different parameters:**

Parameters	Cloud Computing	Fog Computing
Server nodes location	Within the Internet	At the edge of the local network
Client and server distance	Multiple hops	Single/multiple hop
Latency	High	Low
Delay Jitter	High	Low
Security	Non-locally controllable	Locally controllable
Location awareness	No	Yes
Vulnerability	Higher probability	Lower probability
Geographical distribution	Centralized	Dense and Distributed
Number of server nodes	Few	Very large
Real time interactions	Not fully supported	Supported
Usual last mile connectivity	Leased line /wireless	Mainly wireless
Mobility	Limited support	Supported

*See also [29] K.P.Saharan, A.Kumar "Fog in Comparison to Cloud: A Survey", Int'l. Journal of Computer Applications (0975 – 8887) Volume 122 – No.3, July 2015*



# 3. Fog Computing



- Comparison Cloud Computing versus Fog Computing (cont'd)**

	Cloud	Fog
<i>Latency</i>	High (eventual consistency)	Low (locality)
<i>Access</i>	Fixed and wireless	Mainly wireless
<i>Explicit mobility</i>	NA	Lispmob <sup>8</sup>
<i>Control</i>	Centralised/hierarchical (full control)	distributed/hierarchical (partial control)
<i>Service access</i>	through core	at the edge/ on handheld device
<i>Availability</i>	99.99%	Highly volatile/ highly redundant
<i># of users/devices</i>	Tens/Hundreds of millions	Tens of billions
<i>Price per server device</i>	\$1500-3000	\$50-200
<i>Main content generator</i>	Humans	Devices/sensors
<i>Content generation</i>	Central location	Anywhere
<i>Content consumption</i>	End devices	Anywhere
<i>Software virtual infrastructure</i>	Central corporate servers	User devices

Source [4] :L.M. Vaquero, L.Rodero-Merino, "Finding your Way in the Fog: Towards a Comprehensive Definition of Fog Computing", ACM SIGCOMM Computer Comm. Review, Vol. 44, No 5, October 2014



## 3. Fog Computing



- **Fog/Edge (FC) computing applications areas**
- Fog is considered to be an appropriate platform for a large number of Internet of Things (IoT) services and applications- including critical ones:
  - Connected Vehicle
  - Smart Grid
  - Smart Cities
  - Wireless Sensors and Actuators Networks (WSANs)



## 3. Fog Computing



- **Fog (FC) computing enabled applications**
- **Data plane (DPI):**
  - **Pooling of clients idle computing/storage/bandwidth resources and local content**
  - **Content caching at the edge** and bandwidth management at home
  - Client-driven distributed beam-forming
  - **Client-to-client direct** communications (e.g., FlashLinQ, LTE/WiFi Direct, Air Drop)
  - **Cloudlets** (mobility-enhanced small-scale cloud data center located at the edge of the Internet) and micro data-centers
- **Control plane (CPI)**
  - Over the Top (OTT) content management
  - **Fog-RAN: Fog driven radio access network**
  - **Client-based HetNets control**
  - Client-controlled Cloud storage
  - **Session management and signaling load at the edge**
  - Crowd-sensing inference of network states
  - Edge analytics and real-time stream-mining
- **On top of CPI + DPI - appls. as: 5G Mobile, IoT, Cyber-Physical, Data analytics**

*Source [30]: M.Chiang, "Fog Networking: An Overview on Research Opportunities", December 2015, <https://arxiv.org/ftp/arxiv/papers/1601/1601.00835.pdf>*





## 3. Fog Computing



- **Architectural Requirements for Fog** - are related to:
  - Low Latency , Reduced Network Bandwidth
  - Enhanced Security and Privacy
  - Geographic Locality of Control
  - Environmental Constraints
  
  - Hierarchical Organization
  - Multi Tenancy
  - Data Rich Mobility
  
  - Energy Efficiency
  
  - Programmability at Multiple Levels
  - Virtualisation, Orchestration, and Management
  - Supporting Advanced Analytics and Automation
  
  - Scalability
  - Reliability and Robustness
  - Agility, Modularity, Openness

- FC reference architecture

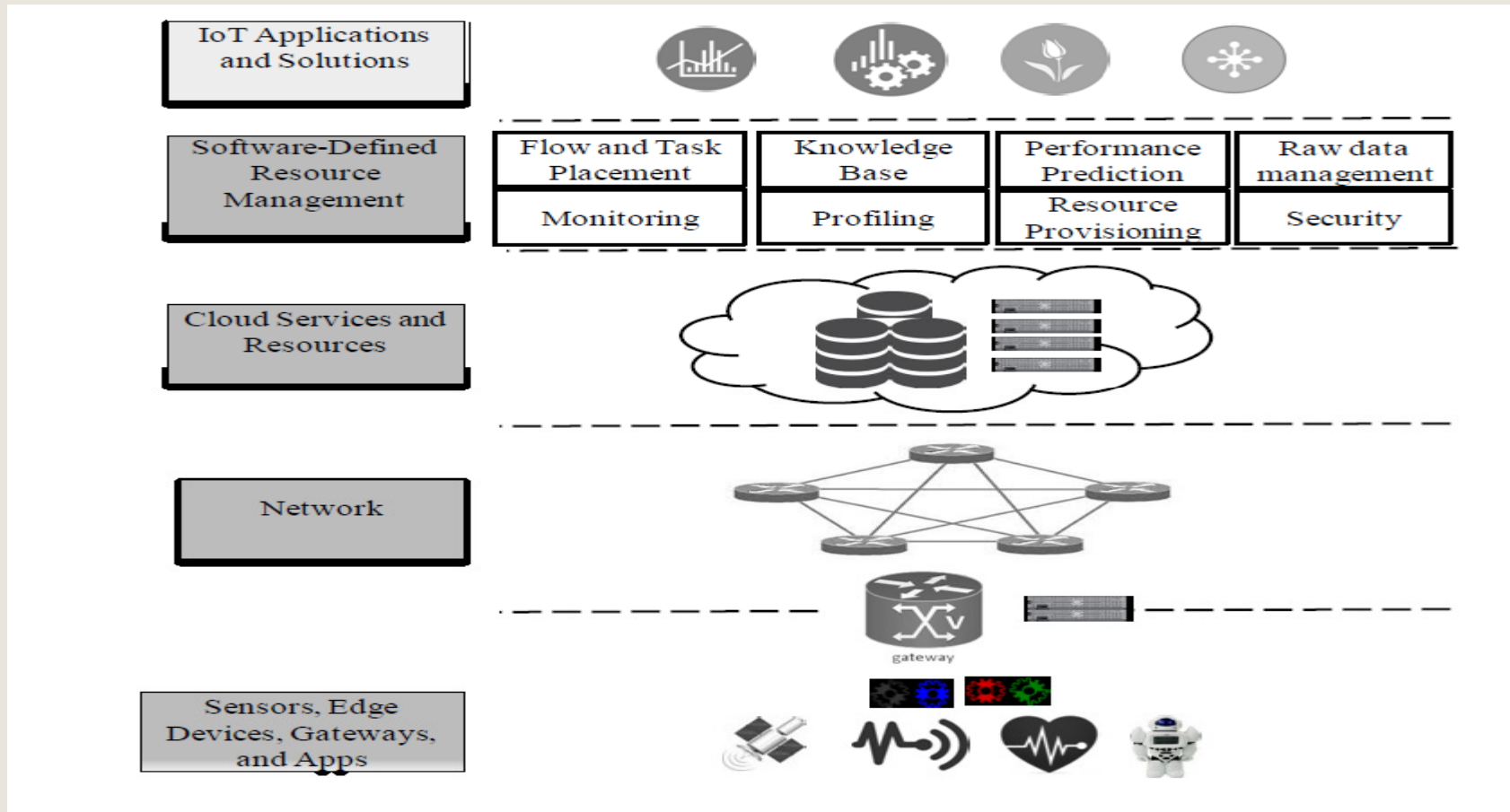

Source [20 ]: A. V.Dastjerdi, et.al., *Fog Computing: Principles, Architectures, and Applications*, 2016  
<https://arxiv.org/abs/1601.02752>,

■ **FC reference architecture Source: CISCO**

- Edge location, location awareness, low latency
- Geographical distribution
- Large-scale sensor networks to monitor the environment, and the Smart Grid
- Very large number of nodes
- Support for mobility
- Real-time interactions
- Predominance of wireless access
- Heterogeneity
- Interoperability and federation
- Support for on-line analytic and interplay with the Cloud

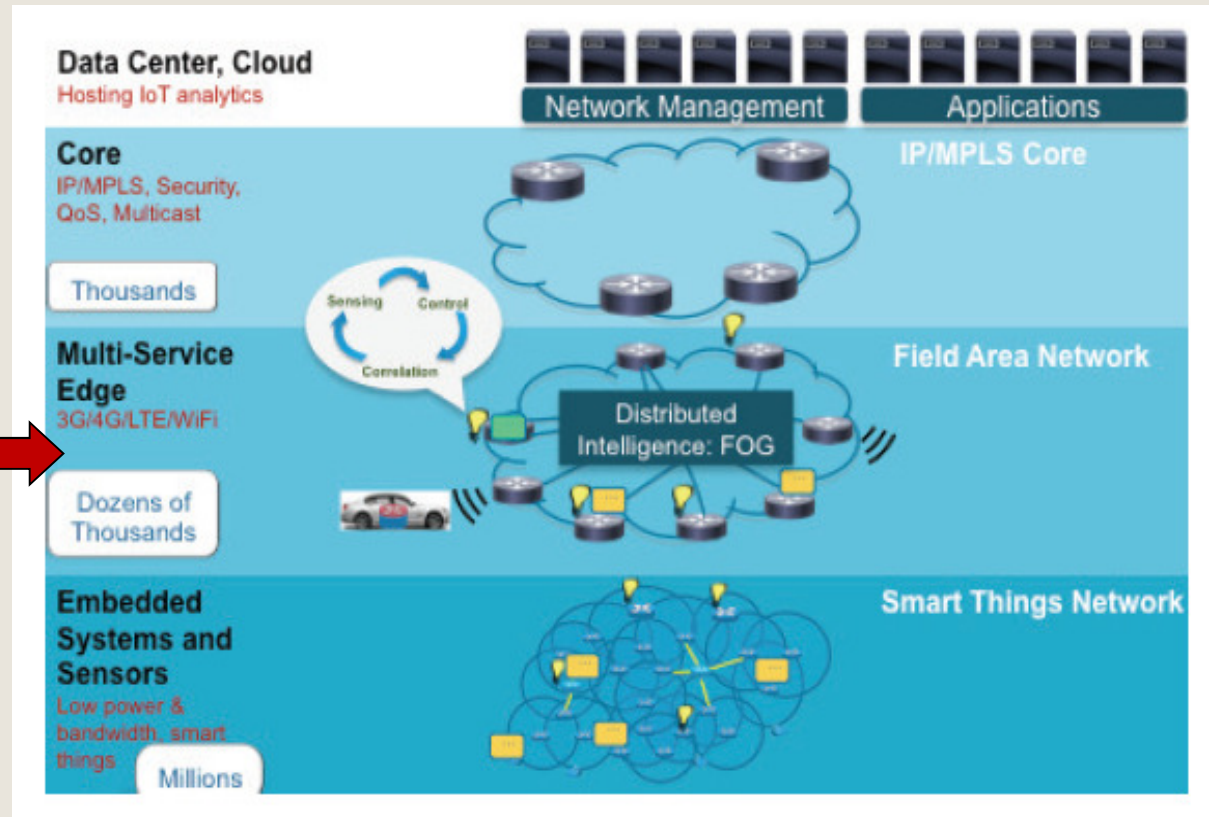

Source [1] :F. Bonomi, R. Milito, J. Zhu, and S. Addepalli, "Fog computing and its role in the internet of things," in *Proceedings of the First Edition of the MCC Workshop on Mobile Cloud Computing, ser. MCC'12. ACM, 2012, pp. 13–16.*

- **Fog and Big Data - Architecture**

- Big Data : characterized by Volume, Velocity, Variety and
    - *geo-distribution* – in case of Fog applications
    - data are processed in several layers

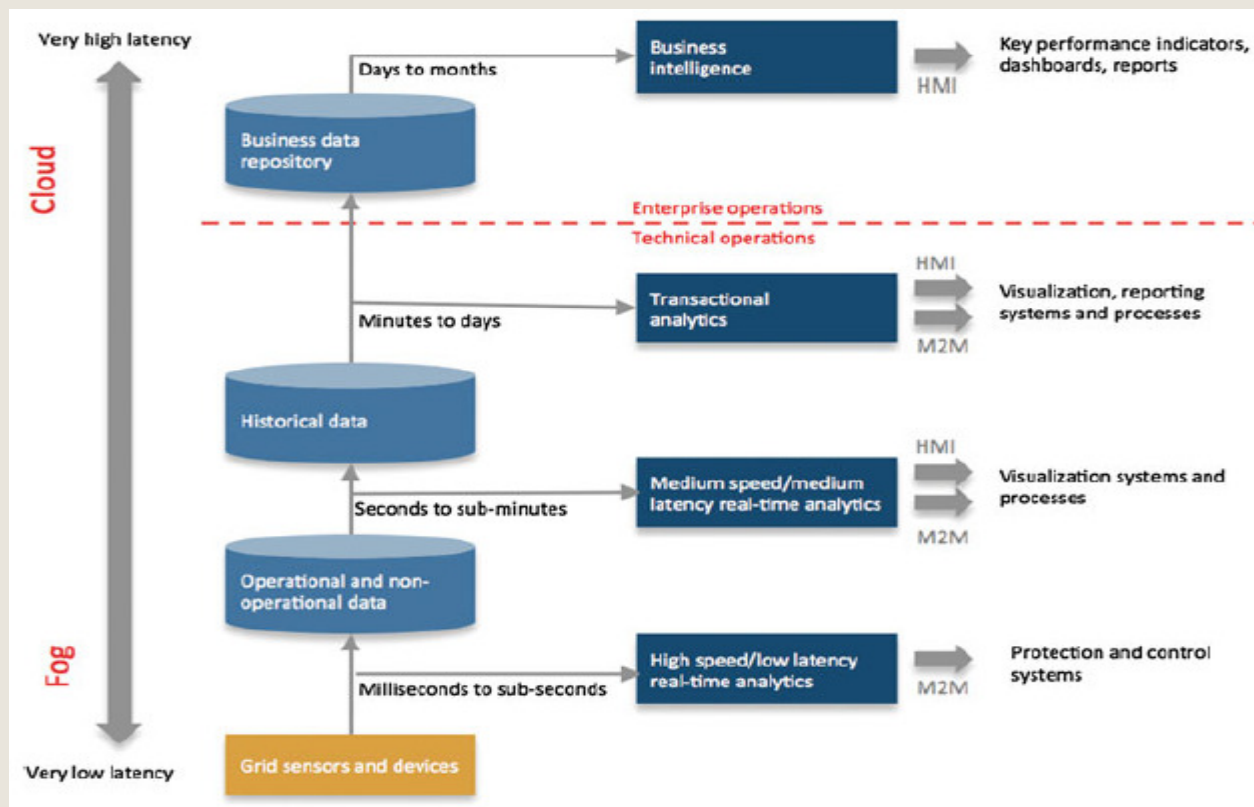

Source [2]: F.Bonomi, R.Milito, P.Natarajan and J.Zhu, "Fog Computing: A Platform for Internet of Things and Analytics", in N. Bessis and C. Dobre (eds.), "Big Data and Internet of Things": 169 A Roadmap for Smart Environments, Studies in Computational Intelligence 546, Springer Int'l Publishing ,2014

- **FC in future smart cities**
  - **Example: Hierarchical distributed FC layered architecture for smart cities**

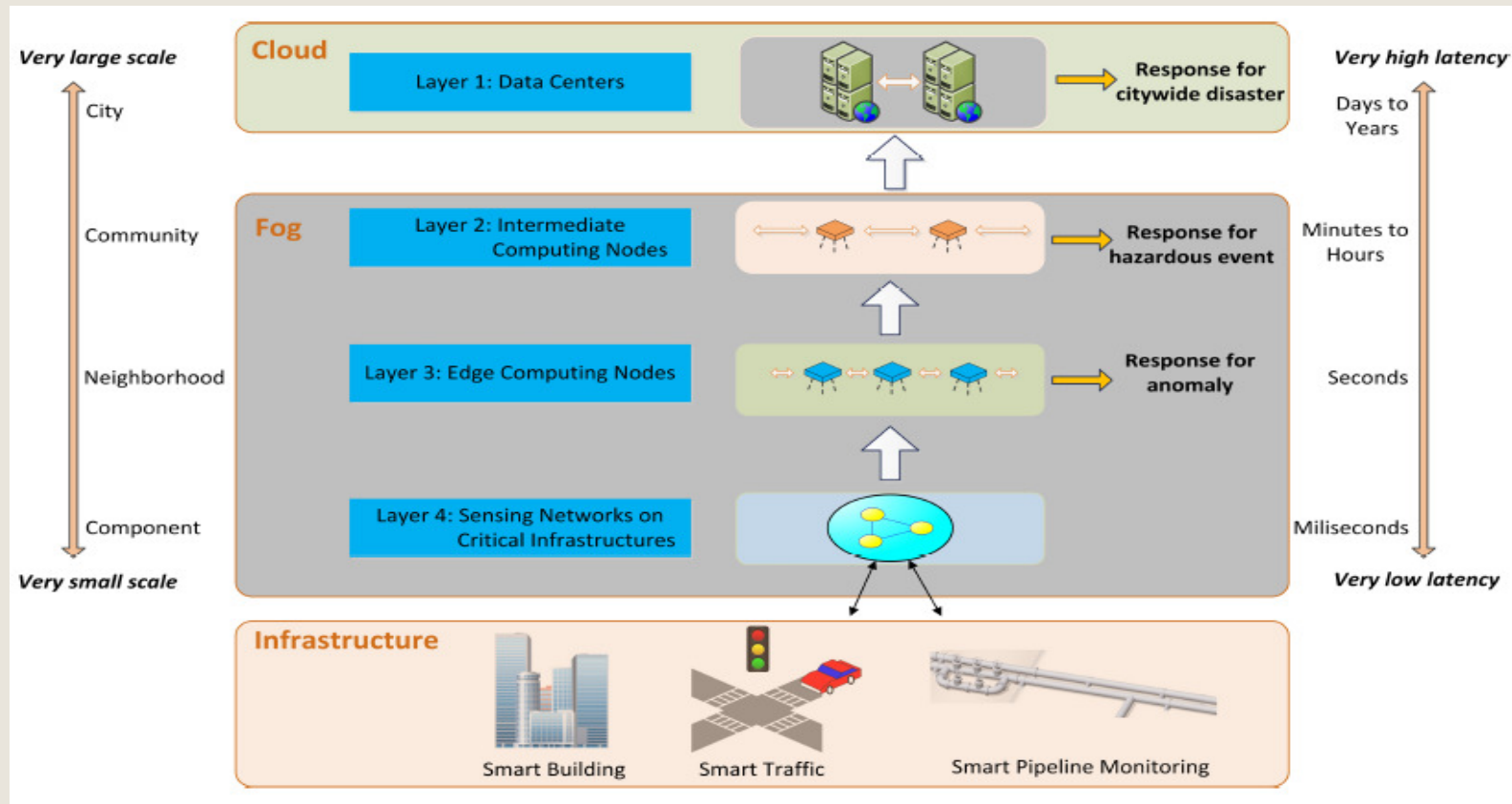

Source [31]: B.Tang, et.al., „A hierarchical distributed fog computing architecture for big data analysis in smart cities”, ASE BD&SI 2015, October 07-09, 2015, Kaohsiung, Taiwan, ACM, <https://www.researchgate.net/publication/281287012>, ISBN 978-1-4503-3735-9

# 3. Fog Computing

- **Distributed IoT/loE applications on the fog infrastructure**

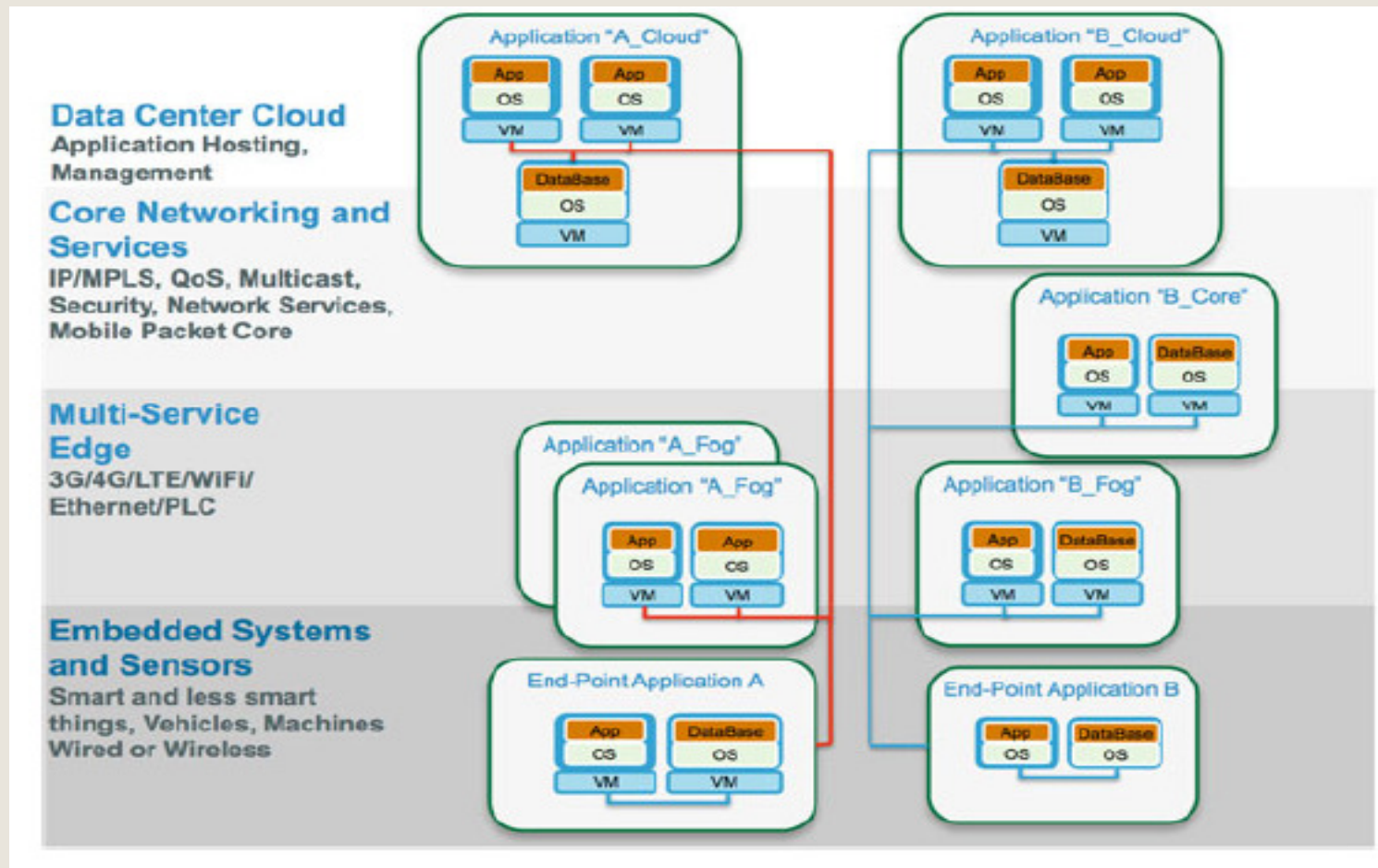

Source [ 2]: F.Bonomi, R.Milito, P.Natarajan and J.Zhu, "Fog Computing: A Platform for Internet of Things and Analytics", in N. Bessis and C. Dobre (eds.), "Big Data and Internet of Things": 169  
*A Roadmap for Smart Environments, Studies in Computational Intelligence 546, Springer Int'l Publishing 2014*

# 3. Fog Computing

- Fog Computing Infrastructure as a Service- architecture example

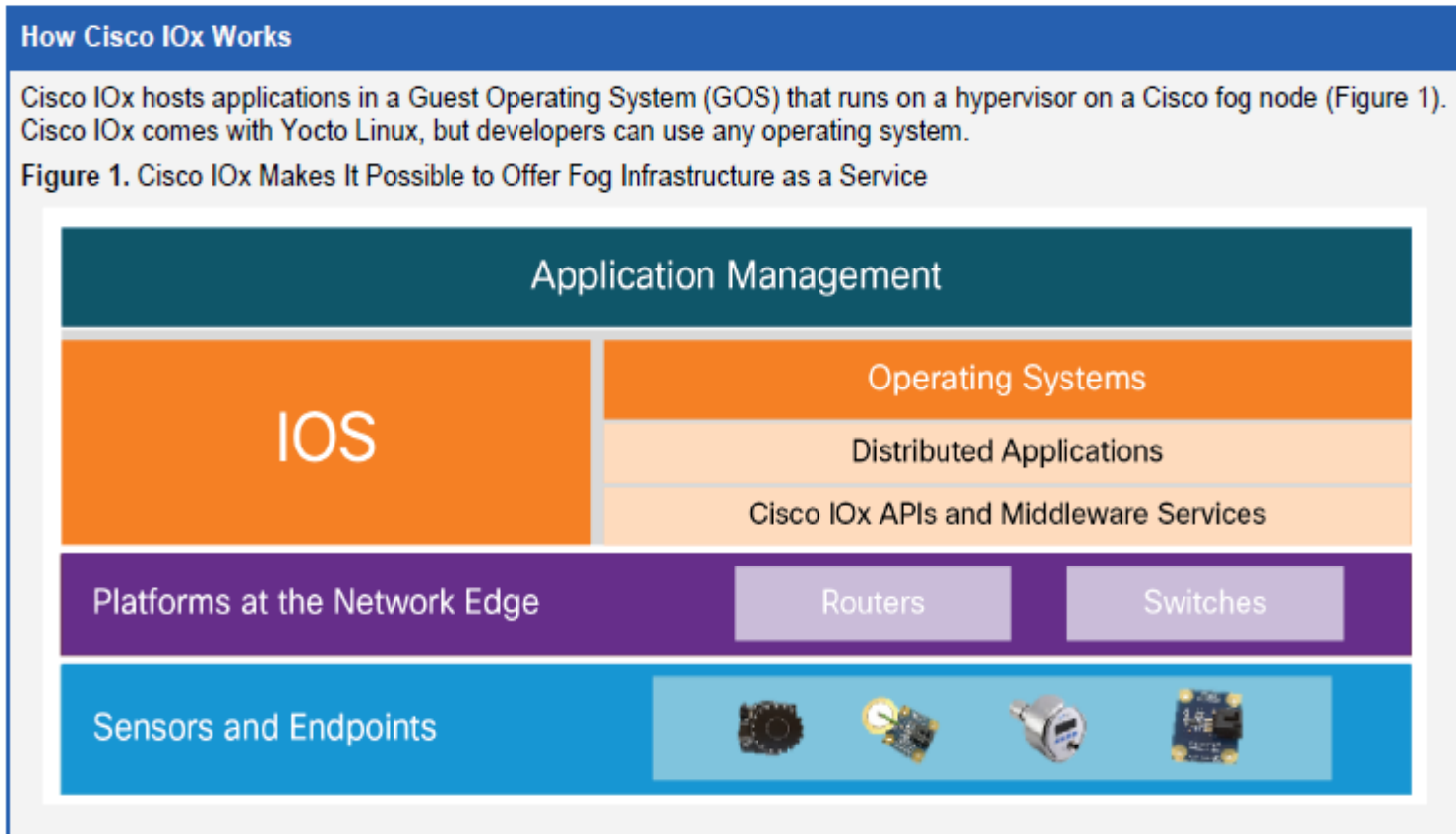

Source [49]: White Paper, "Cisco Fog Computing Solutions: Unleash the Power of the Internet of Things", [https://www.cisco.com/c/dam/en\\_us/solutions/trends/iot/docs/computing-solutions.pdf](https://www.cisco.com/c/dam/en_us/solutions/trends/iot/docs/computing-solutions.pdf)



# 3. Fog Computing



- Example of view on FC software- simplified stack

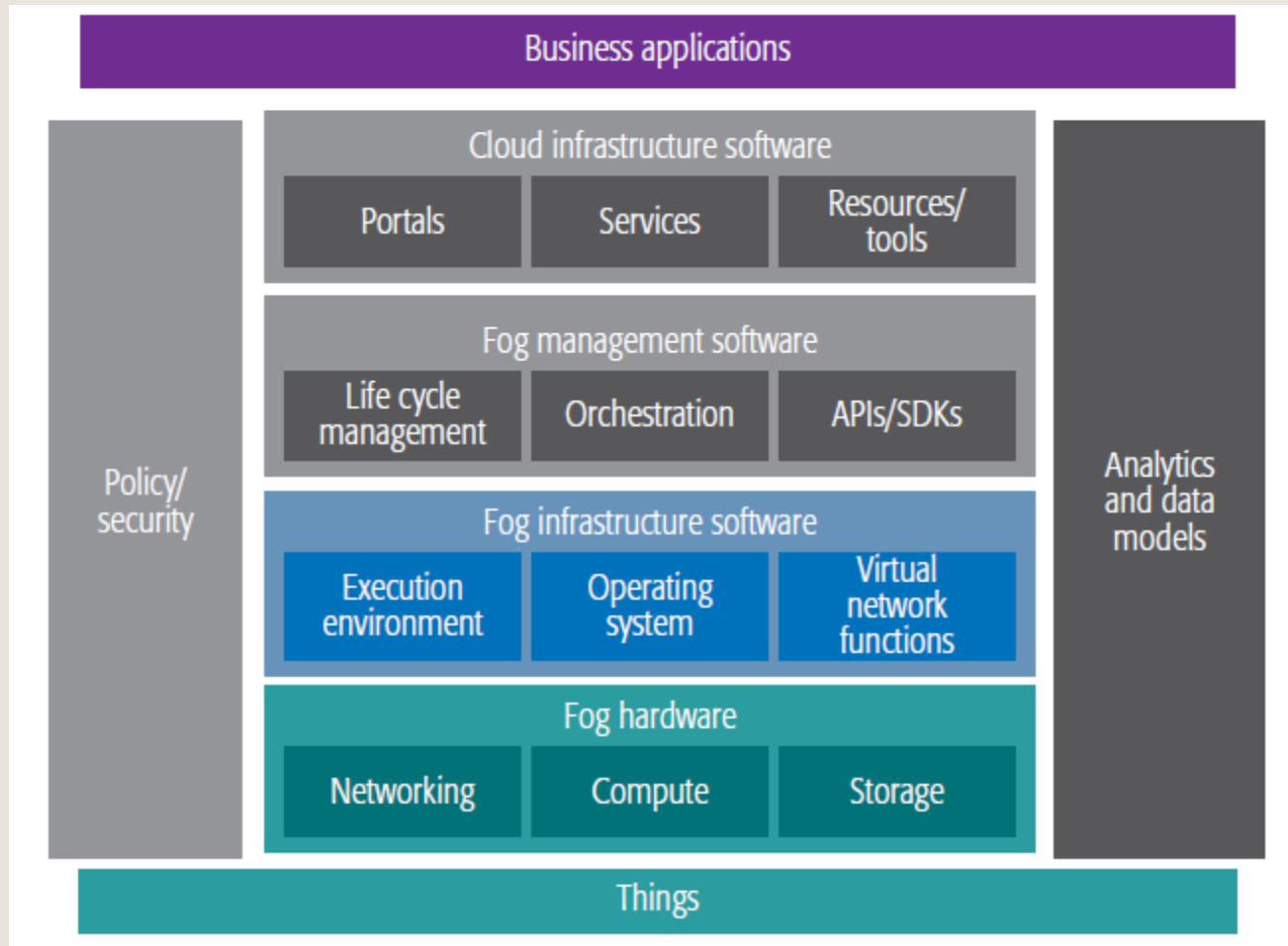

Source[ 27]: C.C. Byers, *Architectural Imperatives for Fog Computing:Use Cases, Requirements, and Architectural Techniques for Fog-Enabled IoT Networks*, *IEEE Communications Magazine*, August 2017, pp.14-20

ComputationWorld 2018 Conference February 18, 2018, Barcelona





# 3. Fog Computing



- OpenFog Consortium vision on FC architecture with perspectives (cont'd)

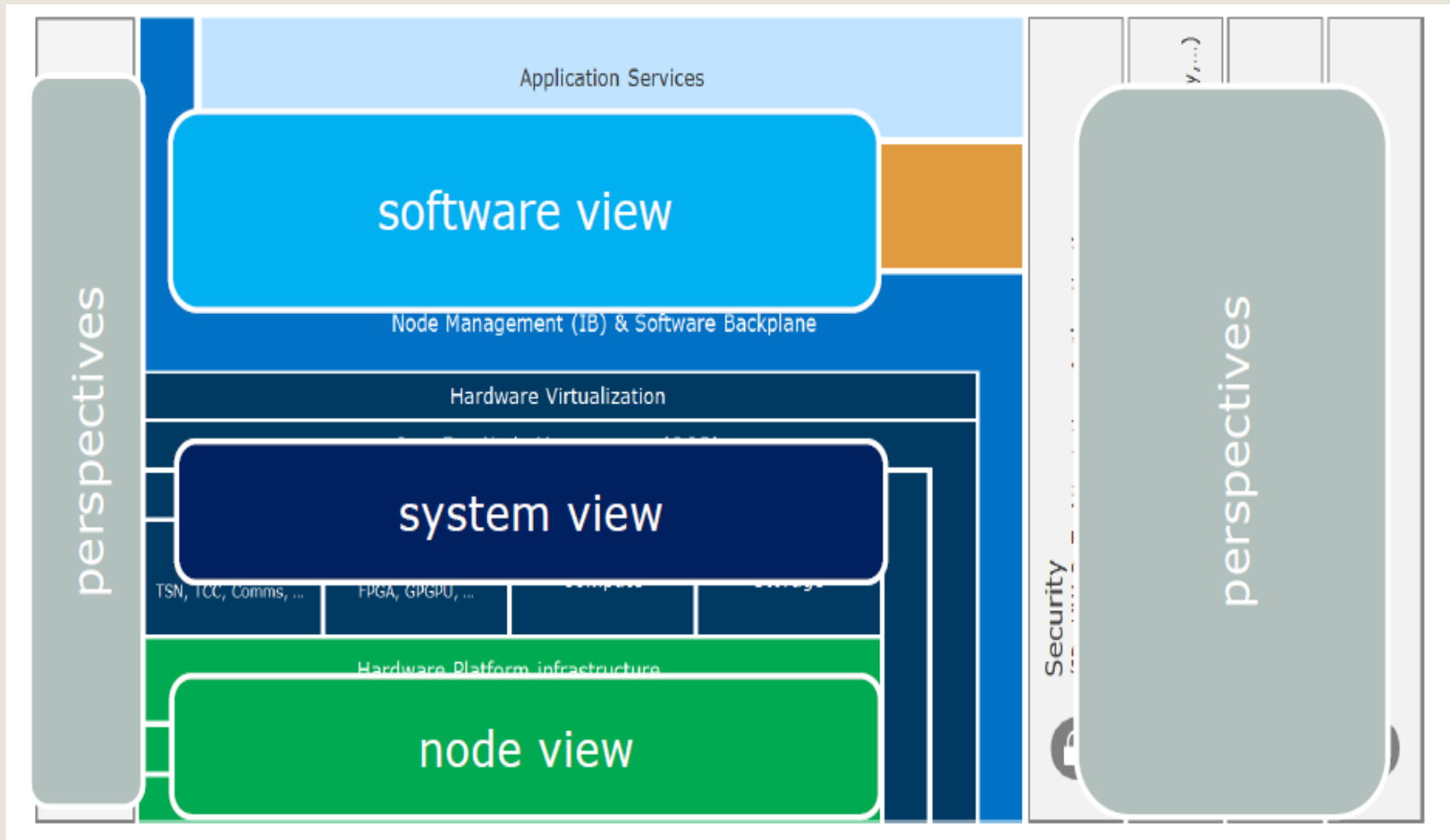

Source [12]: \*\*\* OpenFog Reference Architecture for Fog Computing, February 2017, OpenFog Consortium Architecture Working Group, [www.OpenFogConsortium.org](http://www.OpenFogConsortium.org)

ComputationWorld 2018 Conference February 18, 2018, Barcelona

# 3. Fog Computing

- OpenFog Consortium vision on architecture and perspectives (cont'd)

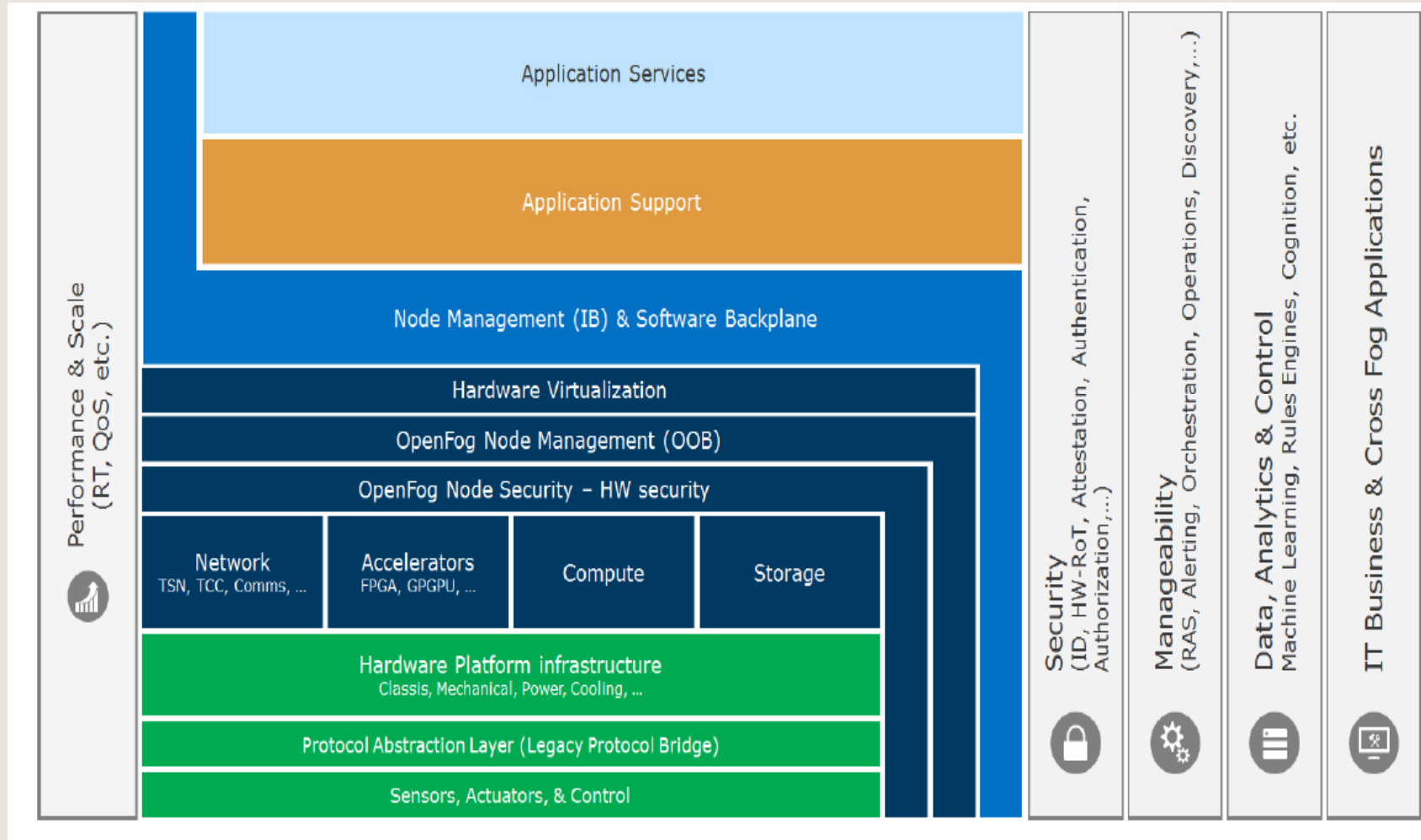

Source [12]: \*\*\* OpenFog Reference Architecture for Fog Computing, February 2017, OpenFog Consortium Architecture Working Group, [www.OpenFogConsortium.org](http://www.OpenFogConsortium.org)



## 3. Fog Computing



- **Technology components needed in FC for scalable virtualisation of the resource classes:**
  - **Computing**, requiring the selection of hypervisors, to virtualise both the computing and I/O resources.
  - **Storage** - needs a Virtual File System and a Virtual Block and/or Object Store.
  - **Networking** - needs a Network Virtualisation Infrastructure (e.g., SDN, NFV)
  - Fog leverages (similar to CC) a **policy-based orchestration** and **provisioning mechanism** on top of the resource virtualisation layer for scalable and automatic resource management.
  - Fog architecture **should expose APIs** for application development and deployment.

- Example of HW/SW Components in Fog architecture

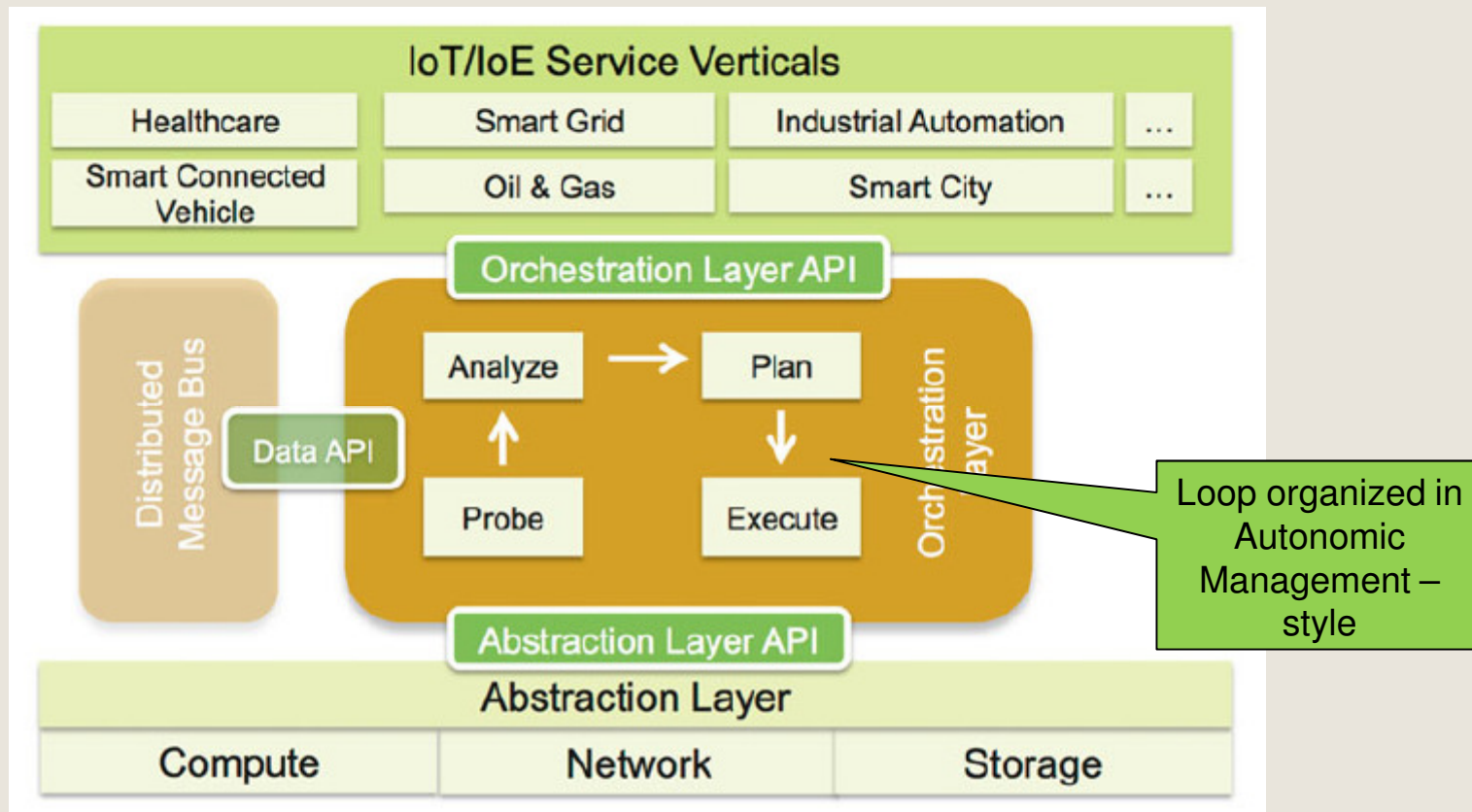

Source [2]: F.Bonomi, et.al., "Fog Computing: A Platform for Internet of Things and Analytics", in N. Bessis and C. Dobre (eds.), "Big Data and Internet of Things": 169  
 A Roadmap for Smart Environments, Studies in Computational Intelligence 546, Springer Int'l Publishing 2014



## 3. Fog Computing



- **HW/SW Components in Fog architecture**
- **Heterogeneous Physical Resources**
  - **Fog: heterogeneous infrastructure of FCNs** (servers, routers, APs, set-top boxes..) and multiple wireless access technologies
  - **Need an abstraction layer on top of these**
- **Fog Abstraction Layer**
  - hides the platform heterogeneity and exposes a uniform and programmable interface for seamless resource M&C
  - provides generic APIs and virtualisation support
  - support **multi-tenancy**
- **Fog Service Orchestration Layer**
  - provides dynamic, **policy-based** life-cycle management of Fog services
  - this functionality is as distributed as the underlying Fog infrastructure and services
- **Management of services** –components :
  - a **SW agent, Foglet** to bear the orchestration fct. and perf. requirements
  - a **distributed, persistent storage to store policies** and resource meta-data (capability, performance, etc)
  - a **scalable messaging bus** for service orchestration and resource mgmt.
  - a **distributed policy engine** with a single global view and local enforcement



## 3. Fog Computing



- **HW/SW Components in Fog architecture**
- **Foglet Software Agent (FSA)**
  - The **distributed Fog orchestration framework** – is implemented by several FSAs, one running on every node in the Fog platform.
  - The FSA uses **abstraction layer APIs** to monitor the health and state associated with the PHY machine and services deployed on it
  - Foglet also performs **life-cycle management** activities
- **Distributed Database (DDB)**
  - **fast storage and retrieval** of data
  - stores both application data and meta-data to aid in Fog service orchestration
- **Policy-Based Service Orchestration**
  - E.g. : **policy-based service routing**, i.e., routing an incoming service request to the appropriate service instance
  - **Examples of policies** : definitions for- **thresholds, QoS requirements, config. policies, power management, security, isolation, privacy, etc.**
  - The **policy manager** – central element
- Business policies are pushed to a distributed policy database



# CONTENTS



1. Introduction
2. Multi-access Edge Computing
3. Fog Computing
4.  Cloudlets
5. Convergence and Open research topics
6. Conclusions



## 4. Cloudlets



- **What is a Cloudlet?**
- Carnegie Mellon University (CMU) has developed *Cloudlets*
- A cloudlet
  - represents **the middle tier of a 3-tier hierarchy**: “mobile device – cloudlet – cloud”
  - can be viewed as a **"data center in a box"**, with no hard state, whose goal is to "bring the cloud closer to the user"
  - CMU have also implemented various mechanisms as open source code which is e.g. available at [35].
- Related proposal- Microsoft Research [10]:
  - concept of micro datacentre as an extension of today's hyperscale cloud data centres (as Microsoft Azure)
  - to meet new application demands like lower latency and new demands related to devices (e.g. lower battery consumption)

*Source [9] M.Satyanarayanan, et.al., "Cloudlets: at the Leading Edge of Mobile-Cloud Convergence", 2014 6th International Conference on Mobile Computing, Applications and Services (MobiCASE) [http://ieeexplore.ieee.org/xpls/abs\\_all.jsp?arnumber=7026272](http://ieeexplore.ieee.org/xpls/abs_all.jsp?arnumber=7026272)*

*Source [10]: Victor Bahl, Microsoft, interview about micro datacentres, Sept 2015. <http://www.networkworld.com/article/2979570/cloud-computing/microsoft-researcher-why-micro-datacenters-really-matter-to-mobiles-future.html>*

*Source [35] :Cloudlets: all about cloudlet-enabled mobile computing. <http://elijah.cs.cmu.edu/>*





## 4. Cloudlets



- **Cloudlet – short overview**
- Cloudlet: architectural element realizing convergence between CC and mobile computing, middle tier of the hierarchy [Cloud-cloudlet- device]
- Cloudlet ~ “data center in a box”
- **Main characteristics**
  - **Technology:**
    - based on standard cloud technology
    - encapsulates offload code from mobile devices in virtual machines (VMs)
    - may have specific role and functionality
    - Similar infrastructure to clouds based on Openstack
  - **Soft state only**
    - no hard state, but may contain cached states from the cloud
    - may buffer data originating from a mobile device and going to the cloud
    - after installation it is entirely self-managing
  - **Location**
    - “Logical proximity” of the mobile devices, i.e., capable to have low E2E latency and high bandwidth (e.g., one-hop Wi-Fi)
  - **Resources and connectivity**
    - sufficient CPU, RAM, etc. to offload resource-intensive computations from several mobile devices
    - good connectivity (bandwidth) to the cloud
    - not limited by electric power supply

ComputationWorld 2018 Conference February 18, 2018, Barcelona



## 4. Cloudlets



### ■ Cloudlet – achievements

- Carnegie Mellon University has created an open source platform
- *Open- Stack++* (<http://elijah.cs.cmu.edu>) [34]
  - derivative of the widely used OpenStack platform for cloud computing (<http://openstack.org>).
  - The “++” refers to the unique extensions necessary for use of OpenStack in cloudlet environments.
- Some key components of OpenStack++ such as cloudlet discovery and just-in-time provisioning have already been developed and are available as open source.
- **Cloudlet is included in Fog technologies by some authors**



# CONTENTS



1. Introduction
2. Multi-access Edge Computing
3. Fog Computing
4. Cloudlets
5.  Convergence and Open research topics
6. Conclusions



## 5. Convergence and open research topics



- **General note:**
  - many common characteristics of the FC, MEC, Cloudlets
  - synergy/convergence is possible and natural
- **General characteristics (FC, MEC, Cloudlets)**
  - **Location, access**
    - Geo-distributed and usually located **between end device and main data center**
    - Cloudlets and even some FC may run on terminal devices
    - Usually located in BSs, APs, aggregation points, routers, switches, GWs
    - Generally – **wireless access**, but not excluding the fixed one
    - Enabling **low latency and jitter**
    - Ruggedized for **outdoor usage- possible**
  - **Multi-tenancy** of apps at the edge and use of virtualized IaaS platform
    - **Many apps. can be served by MEC, FC, Cloudlet**
  - **Typically they are extensions of the cloud** (MEC might be independent)
  - **IoT – is a driving factor** (services requiring distributed computing and storage)
    - Essentially for FC , less for MEC and Cloudlets)
  - **Mobility support for** End devices
  - **Context awareness** of the applications
    - Yes for FC and MEC, it can be added for cloudlets

ComputationWorld 2018 Conference February 18, 2018, Barcelona



## 5. Convergence and open research topics



- **General characteristics (FC, MEC, Cloudlets)** (cont'd)
  - **Federation of services across domains of different edge node ownership and providers**
    - **FC**- yes, however need interoperability features ( Open Fog Consortium)
    - **MEC** ( specified in stds.)
    - **Cloudlet** – yes , need API included in OpenStack
  - **On-line data analytics** and interaction with cloud
    - **FC** – yes
    - **MEC, Cloudlets**- N.A
  - Support for appl. developed on **N-tier hierarchy**- yes, N = 3-FC, (2,3)-MEC, 3-Cloudlet
  - **Near-real-time interaction** amongst same apps. on different edge nodes
    - **FC**- yes, inter-fog node communication can support a fully distributed app.
    - **MEC, Cloudlets** – partial (so far only to support device mobility: the device disassociates from edge node 1 and associates with a new edge node 2 )
  - Specify the need of efficient communication between edge nodes
    - **FC**- yes, **MEC** – yes, **Cloudlet** - No

Notes: *Data analytics* :examining raw data, to draw conclusions about that information  
*DA* focuses on inference, the conclusion are derived solely on what is already known  
*Data mining* - to sort through huge data sets using sophisticated algorithms to identify undiscovered patterns and establish hidden relationships

ComputationWorld 2018 Conference February 18, 2018, Barcelona



## 5. Convergence and open research topics



- **General characteristics (FC, MEC, Cloudlets)** (cont'd)
  - **Providing APIs for provisioning and monitoring virtual resources** for compute, storage, network
    - **FC** – **Fog Abstraction Layer** - provides such APIs. Foglet SW agents use such APIs and constitute a distributed fog orchestration framework
    - **MEC**- this is done via a **Mobile Orchestrator** (borrowing from ETSI network function virtualization (NFV) MANO and service orchestration for NFV)
    - **Cloudlets** - such **APIs** are exposed via **OpenStack** and extensions to OpenStack
  - **Life-cycle management** of distributed cloud apps
    - **FC**- Fog Service Orchestration Layer
    - **MEC**- Mobile Orchestrator and OSS/BSS of the telecoms network operator
    - **Cloudlets**- partially specified
  - **Support for different use cases** from multiple vertical industries
    - **FC** - yes, e.g., smart cities with smart traffic lights, energy (wind farms)
    - **MEC**- yes, e.g., security industry, content delivery industry
    - **Cloudlet**- yes , e.g. health sector, security sector, consumer services discretionary with cognitive assistance



## 5. Convergence and open research topics



- **Open Edge Computing (OEC) – novel general approach**
  - **Edge Computing:** **small data centers** at the **network edge** offering computing and storage resources next to the user
- **Carnegie Mellon University**- early work on Cloudlets at the edge
- **2015: overlapping interests in MEC → a few parties joined research efforts under the open source banner of Open Edge Computing (OEC)**
  - Currently, OEC ecosystem includes **CMU**, **Intel**, **Huawei**, **Vodafone**, ..
- **Main OEC goals :**
  - To promote Cloudlets as enabling technology
  - **To drive**
    - The necessary technology for various use cases (low latency and computation at the edge) (e.g. extensions to OpenStack, KVM, QEMU).
    - prototyping of applications that leverage EC pushing the boundaries and demonstrating benefits
    - the eco system development for OEC and use current IT solutions
  - Engaging with
    - target service industries/sectors through demonstrators and joint projects
    - developer communities, seeking feedback and driving EC acceptance
  - Synchronising work with other efforts incl. ETSI ISG MEC and OPNFV.

*Source [36] <http://openedgecomputing.org/about-oec.html>*

ComputationWorld 2018 Conference February 18, 2018, Barcelona

## 5. Convergence and open research topics

- **Open Edge Computing (OEC) : OEC status** – (cont'd)
  - **Basic Edge Server** technology – market-available from several telco vendors (~2013); ~ All vendors work on edge solutions.
  - Many telecom operators - perform trials with edge technology
  - Some operators have already launched edge services (e.g. edge caching)
  - EC initiatives exist in several industries
    - ETSI Industry Specification Group **MEC** - develops req., arch. and specs
    - IT industry initiatives: **OpenStack Foundation, OpenFog**

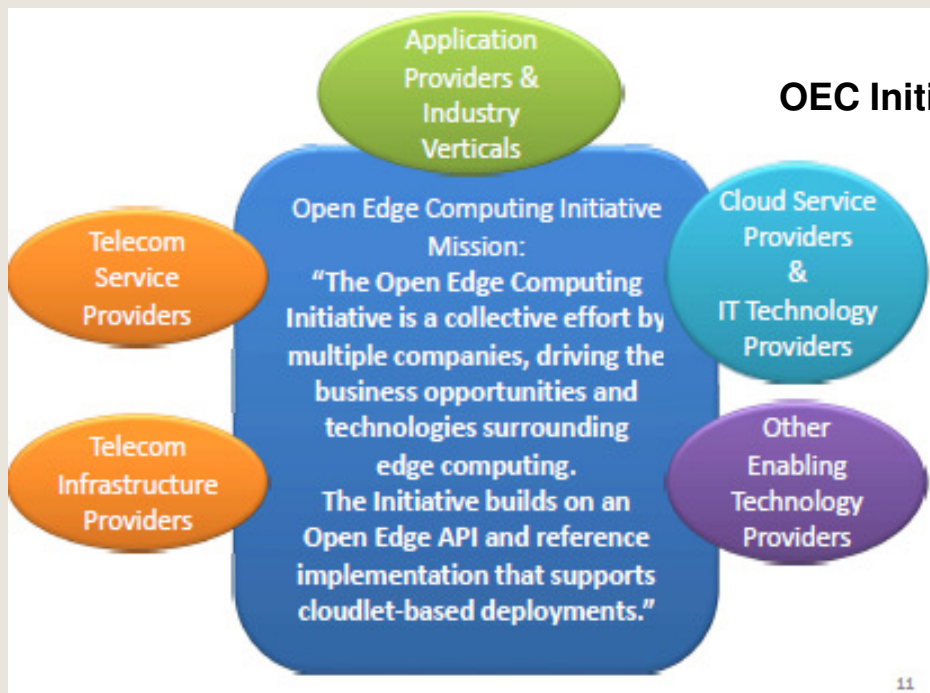

**Main target: provide an OE API and reference platform for OEC and align it with the IT industry and the telecoms industry**

*Source [37] : R.Schuster, P. Ramchandran, OPEN EDGE COMPUTING – FROM VISION TO REALITY -2016, OPNFV Design Summit, Berlin, Germany*



- **Open Edge Computing (OEC) - general approach**
- The OEC servers can be located close/associated to Base Stations, Access Points, Small Cells, ...or even in the Operator Core Network
- **Edge Computing** will utilize the **Network Function Virtualisation (NFV)** infrastructure wherever possible
- This will reduce deployment cost of EC significantly

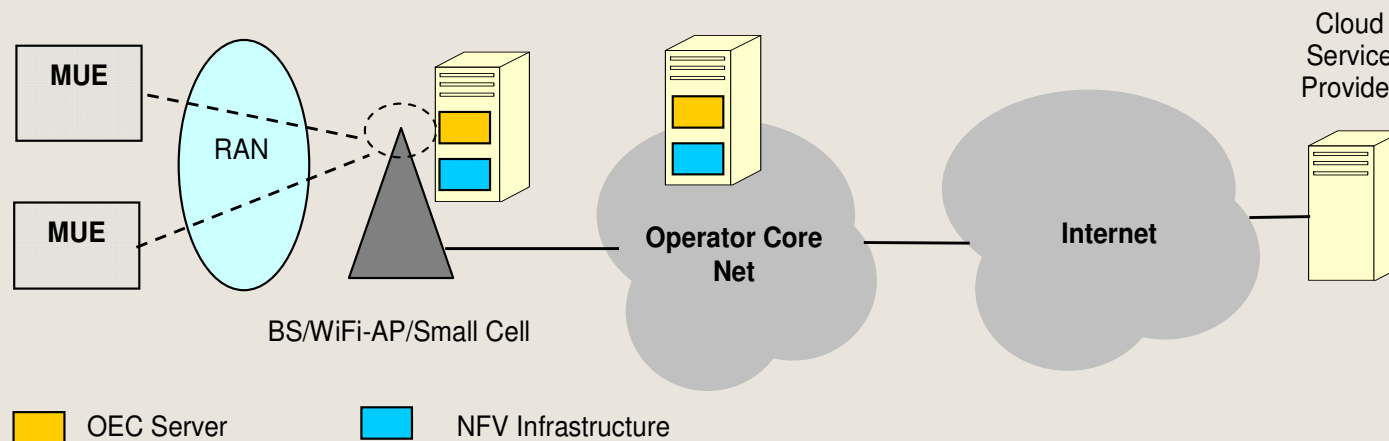

*Adapted from Source [37] : R.Schuster, P. Ramchandran, OPEN EDGE COMPUTING – FROM VISION TO REALITY -2016, OPNFV Design Summit, Berlin, Germany*

ComputationWorld 2018 Conference February 18, 2018, Barcelona

- **OEC (cont'd): Open Edge Services main Requirements**
  - to have a globally agreed structure and to be available everywhere
  - to be **independent** of
    - the communication bearer and network provider
    - the underlying technology and its provider
  - **open to all application categories + technologies**
  - to support all relevant business scenarios
- **Edge Operator –novel business entity**, placed between the users and **App. Service Provider** or **Cloud Provider**

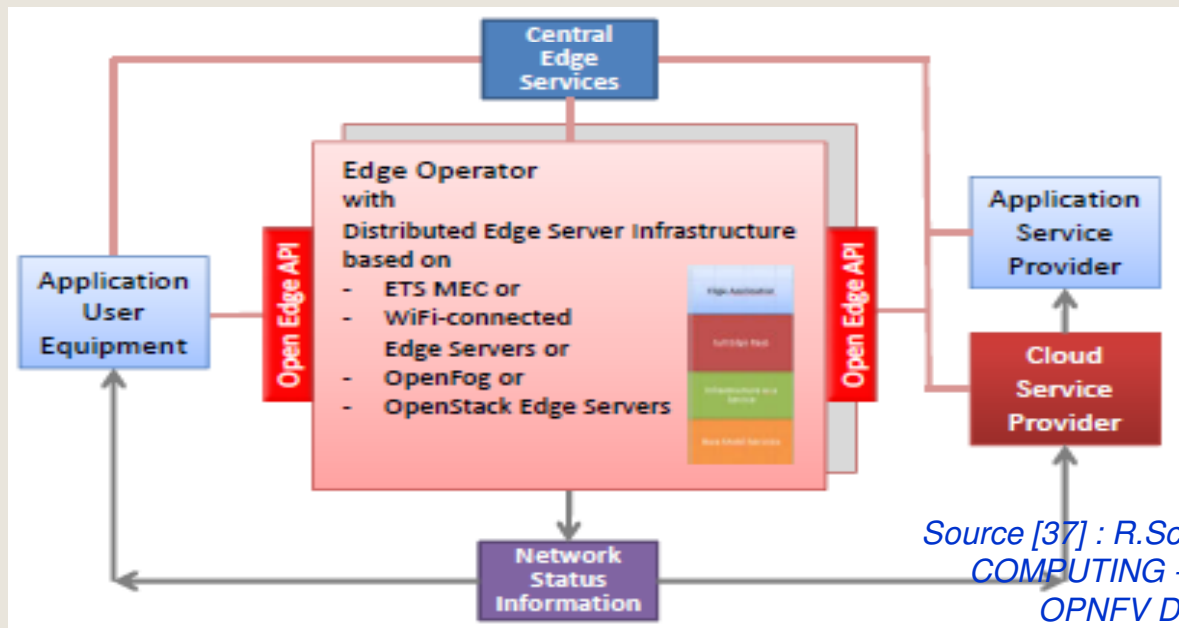

OEC:  
OpenEdge API

Source [37] : R.Schuster, P. Ramchandran, OPEN EDGE COMPUTING - FROM VISION TO REALITY -2016 OPNFV Design Summit, Berlin, Germany

- **OEC (cont'd): Key Reference Platform Functions and API**
  - A -Edge Server (Cloudlet) Discovery – discover the best and closest edge server
  - B- VM Provisioning – fast provisioning of VM and app on selected edge server
  - C-VM Handoff – handoff of application to next edge server in case of movement

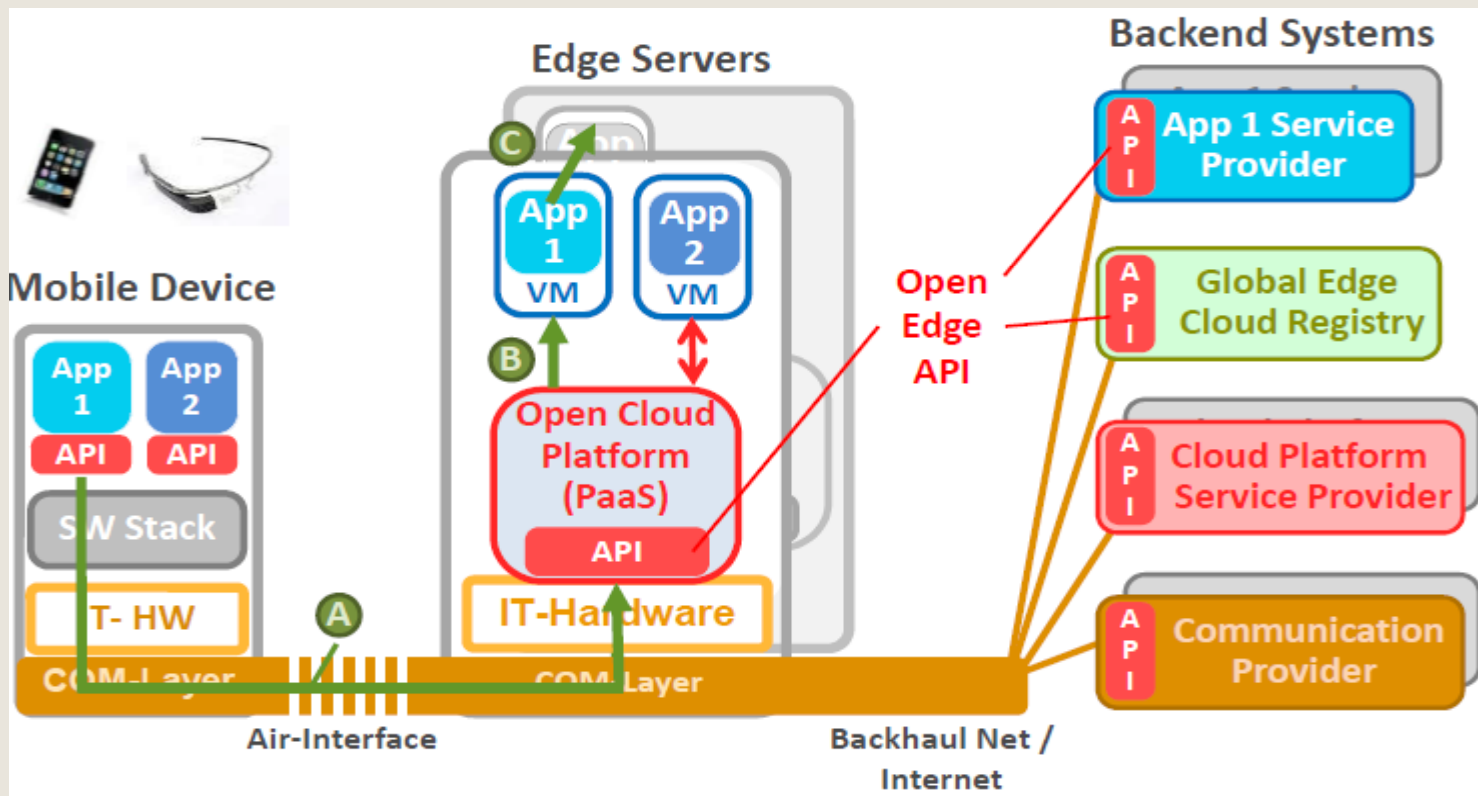

Source [37] : R.Schuster, P. Ramchandran, OPEN EDGE COMPUTING - FROM VISION TO REALITY -2016, OPNFV Design Summit, Berlin

ComputationWorld 2018 Conference February 18, 2018, Barcelona



## 5. Convergence and open research topics



- **Recent proposals – convergence oriented**
- **1. NFV, 5G, and Fog: A Model-Driven Approach to fuse Cloud and Edge**
- CC and FC have been defined as complementary
- A modified architecture (below) is an attempt **to fuse fog and cloud**
  - *Source [50] Frank van Lingen, et.al., “The Unavoidable Convergence of NFV, 5G, and Fog: A Model-Driven Approach to Bridge Cloud and Edge”, IEEE Communications Magazine, August 2017, pp.28-35*
  - **CC + FC = one computing fabric**, managed as a single entity, in a srv.-centric way; i.e., The infrastructure (fog, network, and cloud nodes ) is managed as a unified resource fabric.
  - Admin. can decide where to instantiate resources according to the service requirements.
  - **CC and FC nodes are treated architecturally the same**; the service management platform unifies the services LCM ,that might require instances running in the **fog, cloud, or a combination**.
  - **Distinctive features** (fog, network, or cloud node) are captured by their corresponding YANG models [51].
  - **Advantage** : different IoT services can coexist and be managed in a uniform way.
  - *[51] “YANG — A Data Modeling Language for the Network Configuration Protocol (NETCONF),” IETF RFC 6020; <http://www.rfc-editor.org/rfc/rfc6020.txt>, accessed May 10, 2017.*

ComputationWorld 2018 Conference February 18, 2018, Barcelona

## 5. Convergence and open research topics

- **Novel proposals – convergence oriented**
- **NFV, 5G, and Fog: A Model-Driven Approach to fuse Cloud and Edge** (cont'd)
  - ETSI MANO arch. extended to cover service management beyond the traditional NFV and networking domains.

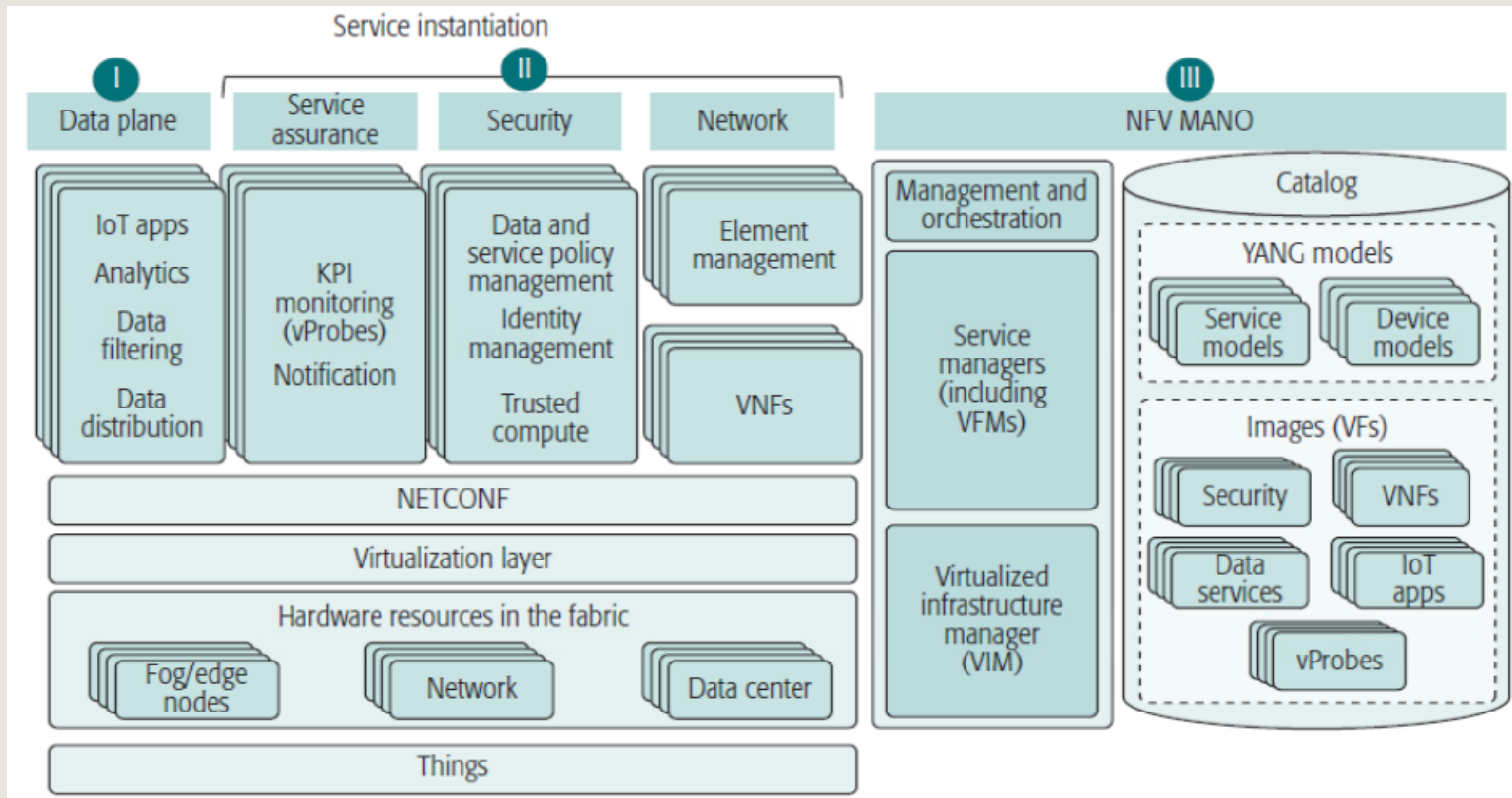

Source [50] Frank van Lingen, et al., "The Unavoidable Convergence of NFV, 5G, and Fog: A Model-Driven Approach to Bridge Cloud and Edge", *IEEE Communications Magazine*, August 2017, pp.28-35



## 5. Convergence and open research topics



- **Novel proposals – convergence oriented (cont'd)**
- **NFV, 5G, and Fog: A Model-Driven Approach to fuse Cloud and Edge (cont'd)**
- Two-layer abstraction:
  - Separation of the “service intention” ( “what”) from the “service instantiation” ( “how”)
  - Service instantiation decoupling from the deployment location (specific devices- in the cloud or network, or at the edge)
- The building blocks are split into three parts
  - the data plane
  - basic components to support data plane functionality (service assurance, security, and networking)
  - management plane based on NFV MANO.
- **Open research issues on this architecture: business model, scalability ?**

*Source [50] Frank van Lingen, et.al., “The Unavoidable Convergence of NFV, 5G, and Fog: A Model-Driven Approach to Bridge Cloud and Edge”, IEEE Communications Magazine, August 2017, pp.28-35*



## 5. Convergence and open research topics



- **Recent proposals – convergence oriented (cont'd)**
- **2.Unified FC and CC architecture : TelcoFog for 5G networks**
  - *Source [52]: R. Vilalta, et.al., “TelcoFog: A Unified Flexible Fog and Cloud Computing Architecture for 5G Networks”, IEEE Communications Magazine, August 2017, pp.36-43*
  - **Novel FC infrastructure** - secure, highly distributed, programmable and ultra-dense, allocated at the edge of a wired/wireless network of a telecom operator
    - to provide multiple unified, cost-effective, and new 5G services, such as NFV, MEC, and services for third parties (e.g., smart cities, vertical industries, and IoT)
  - **TelcoFog is designed to integrate NFV, MEC, and IoT services** for an operator
  - Three main **types of building block** :
    - **TelcoFog nodes** - scalable and seamlessly integrated in the telecom infrastructure;
    - **TelcoFog controller**, focused on service assurance and based on service data modeling (YANG) - integrated in the management and orchestration architecture
    - **TelcoFog services** - running on top of the TelcoFog and telecom infrastructure.

## 5. Convergence and open research topics

- Recent proposals – convergence oriented (cont'd)
- 2.Unified FC and CC architecture : TelcoFog for 5G networks (cont'd)
  - TelcoFog architecture

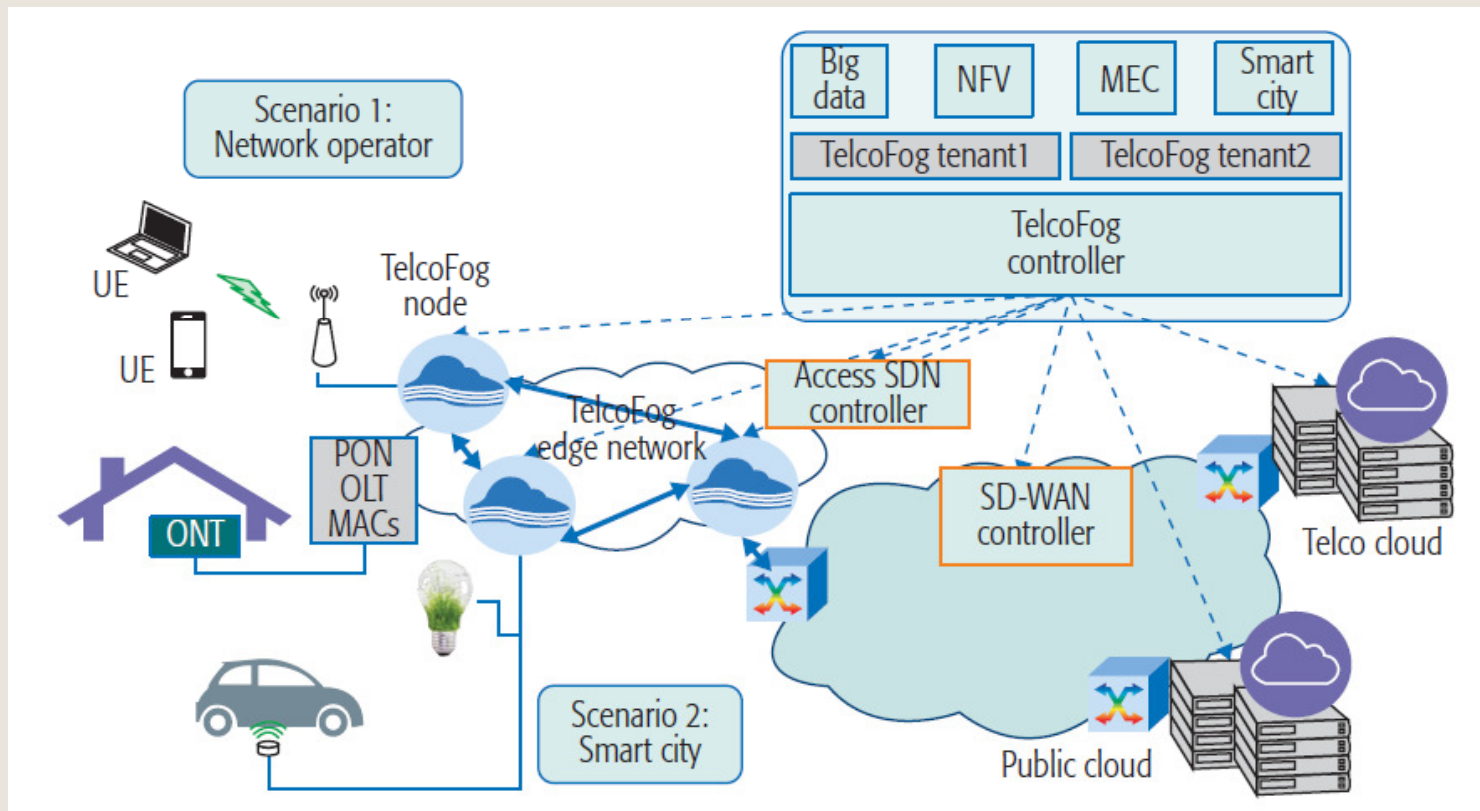

Source [52]: R. Vilalta, et.al., "TelcoFog: A Unified Flexible Fog and Cloud Computing Architecture for 5G Networks", *IEEE Communications Magazine*, August 2017, pp.36-43

ComputationWorld 2018 Conference February 18, 2018, Barcelona





## 5. Convergence and open research topics



### ■ Technical/research open topics

- **Interworking** between **edge clouds**
  - (in FC, ETSI MEC server, Cloudlet) and **main clouds** (e.g., Microsoft, HP, IBM, Google etc.) belonging to different domains (operated by different providers)
- **Design techniques for cloud-native applications** (e.g., for IoT) to be deployable in a distributed cloud environment (e.g., IoT device, a fog platform or Cloudlet of provider X, and a main cloud).
  - Example use case: smart traffic light
- **Extension of**
  - IP routers to become fog nodes (e.g., Cisco IOX),
  - LTE base stations to become MEC nodes (e.g., NOKIA)
  - Hyper-scale cloud data center to reach out to the edge as well (e.g. Microsoft Azure)
- **Design of distributed cloud applications** for deployment across the chain :
  - a main data center + multiple FC nodes + end points (the “things” in the Internet)
- **Develop methodology to deploy edge/fog appl. in a 3+ tier way** , similar to the smooth way, as for today’s cloud offerings (e.g. Amazon EC2, Microsoft Azure etc.)
  - Fog/edge architectures have to further develop APIs for application development and deployment



## 5. Convergence and open research topics



### ■ Business cooperation needs

- Stronger **cooperation** between
  - FC and EC interested players and traditional CC big players
  - ETSI ISG MEC and traditional CC the big players (Microsoft, Amazon, ..) and also with OEC
- Bridging the gap between “the novel concept” FC, MEC, Cloudlet and the industrial corporate clients/actors
  - e.g. to sell the concept to industry leaders in CC, and convince them to promote and introduce the new technology to their clients
- **Conventional Cloud – to migrate towards Intelligent Cloud** (including IoT, IoE)
- **Specific steps already started-** examples
  - Expanding the coverage of the public cloud data centers into more regions
  - Adding cloud GWs close to the IoT data sources and inject data into the main cloud
  - Adding PaaS or SaaS features (e.g., machine learning software - Microsoft Azure ML)
  - Adding real-time analytics engines to the clouds
  - Adding tools for corporate clients to deploy IoT applications across the Cloud.
  - Partnering with key players in the IoT device platform market



## 5. Convergence and open research topics



- **Technical/research open topics** (cont'd)
  - Determining the needs/requirements and constraints of vertical industries for **security and privacy** in the context of distributed cloud, edge cloud and fog.
  - Studying possible **operational /business models**:
    - Who would operate E2E appl. ?
    - Where/which part of the application is hosted
      - in a big public or hybrid cloud,
      - in edge cloud computing nodes and fog nodes
      - on the devices?
    - Develop the **service guarantees** (QoS, QoE) , framework ( SLAs..)
      - how do service guarantees fit together
      - **which party is responsible** for the E2E quality of the distributed cloud application?



## 5. Convergence and open research topics



- **Technical/research open topics** (cont'd)
- **Fog Computing specific issues**
- **Communications between Mobile User Equipment and Fog Servers**
  - **Cross-layer Design:**
    - The **fog server manages an autonomous network**, by providing both service applications and wireless communications to mobile users.
    - It can manage all layers and enable the cross-layer design to provide the best service quality to users (e.g., caching a number of videos)
  - **Predictable User Feature and Demand:**
    - A **Fog server needs to adapt to RAN interfaces** to fully explore the localized user features and service demand
    - It may run specific **prediction algorithms** (e.g., for shopping malls, bus, V2X, etc.) to evaluate estimate the evolution of the demand



## 5. Convergence and open research topics



- **Technical/research open topics** (cont'd)
- **Fog Computing specific issues** (cont'd)
  
- **Communications between Fog Servers – Central Cloud**
  - The cloud DC is the central controller and store - it manages and coordinates the distributed Fog servers
  - Different Fog servers select the information contents from the cloud and then deliver the replicas from its cache to the mobile users
  - A cloud server manages the applications and contents for the entire system
  - At a particular Fog server, selective localized applications should be provisioned and synchronized with the cloud

- **Technical/research open topics** (cont'd)
- **Fog Computing specific issues**
  - **Fog - Cloud Communications** (cont'd)
  - If SDN approach is adopted then the cloud
    - manages the network with a global (SDN principle) view
    - the cloud establish the routing path of data to update the geo-distributed Fog servers (+ control plane and data plane separation).

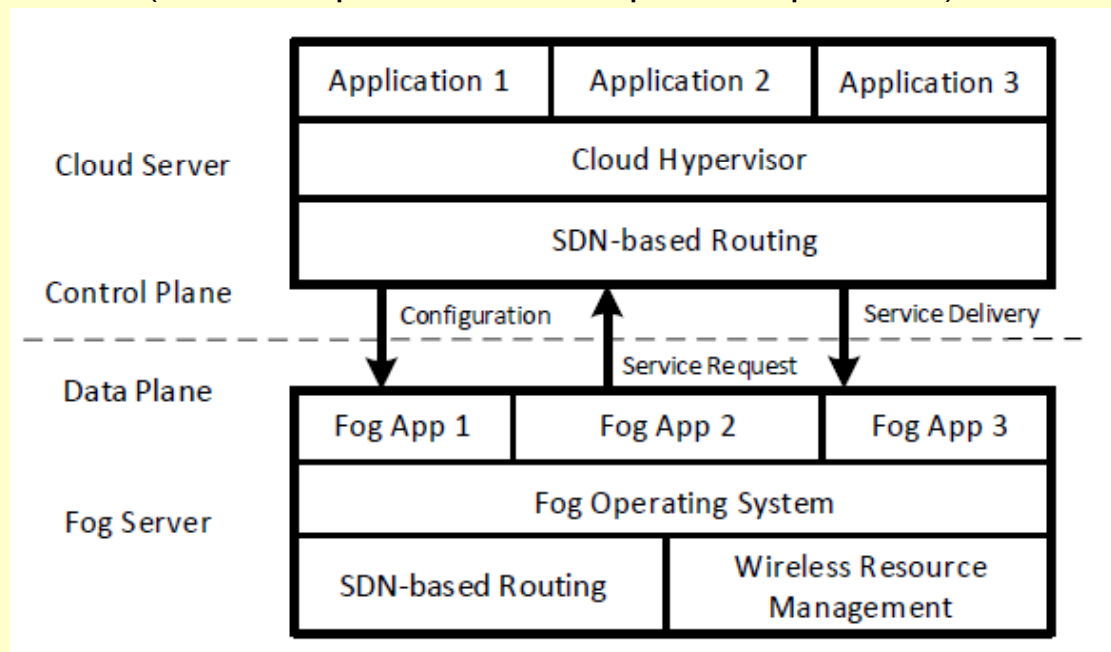

Source [28]: T H. Luan et.; al. , "Fog Computing: Focusing on Mobile Users at the Edge",  
arXiv:1502.01815v3 [cs.NI] 30 Mar 2016

ComputationWorld 2018 Conference February 18, 2018, Barcelona



## 5. Convergence and open research topics



- **Technical/research open topics** (cont'd)
- **Fog Computing specific issues** (cont'd)
- **Communications between Fog Servers**
  - A **Fog Server (FS) manages** a pool of resources **locally** → need of collaborative service provision and content delivery among peered FSs
  - The data routing among FSs can be managed
    - either by a centralized manner using the SDN-based approach,
    - or, by a fully distributed manner ~ traditional routing mechanism (e.g., OSPF).
- **Data transmission challenges:**
  - **Service policy:**
    - the FSs at **different locations** may belong to **different business actors**
    - they may conform to **different policies** defined by owners → data routing among FSs needs to address the heterogeneous service policies.
  - **Topology:**
    - If FSs co-located in the same region are connected to the Internet through the same ISP with the high-rate low-cost connections,
    - then direct communications via Internet can alleviate the traffic between cloud and FSs
  - **Connection:**
    - **Optimization problem is open** - the data routing among FSs (wired connections over Internet or wireless connections through opportunistic connections)

ComputationWorld 2018 Conference February 18, 2018, Barcelona



## 5. Convergence and open research topics



- **Technical/research open topics** (cont'd)
- **Fog Computing specific issues** (cont'd)
  
- **Fog Computing Deployment**
  - Additional computing and storage resources at the edge is necessary
  - The **FS needs to adapt its services** → extra management and maintenance cost.
  
  - The FC operator Should address challenges
    - **Application:** customize the applications embedded in each of the FS based on the local demand
  
    - **Scaling:** anticipate the demand of each of the FSs and deploy adequate fog resources so as to sufficiently provision
  
    - **Placement:** A group of FS can collaboratively provide service applications to mobile users nearby





## 5. Convergence and open research topics



- **Technical/research open topics**
- **Fog Computing specific issues**
  
- **Supporting Technologies: 5G, SDN, NFV**
  - 5G: The Fog layers can be adapted by using the existing accessing networks, e.g., WiFi, or emerging 5G wireless technologies with a virtualized architecture
  - Usage of FC approach in 5G slicing
  - **Network Function Virtualization (NFV)** - enable VNFs inside network nodes, e.g., switches and routers
  - FC enable virtualized location-based applications at the edge device and providing desirable services to localized mobile users.
  - With a global network view, the cloud can manage the entire network using a SDN approach



## 5. Convergence and open research topics



- **Technical/research open topics** (cont'd)
  - **Mobile Edge computing – specific issues**
    - Standardized open environment - further developed to allow seamless and proficiently integration of traditional apps. across the MEC platform
    - **Multi-access further development of MEC architecture**
    - Simulation platform/ PoCs to experiment for various MEC scenario can cut costs of development
    - Implementing a **mobility management** (V/H) allowing users to seamlessly access edge applications **including service continuity**
    - Heterogeneous access management : 3G, 4G, 5G, WiFi, WiMAX, Bluetooth, ..
    - **MEC and 5G slicing**
    - Combining MEC with Fog in CRAN/H-CRAN architectures
    - Pricing models
    - Scalability assurance ( application migration, load balancing, ..)
    - Security problems for applications running in MEC
  - **Cloudlet specific issues**
    - optimal cloudlet selection and seamless cloudlet handoff ?
    - **OpenStack++**
      - effort to become a universally deployable cloudlet platform
      - above and below which many proprietary HW/SW and service innovations can emerge

ComputationWorld 2018 Conference February 18, 2018, Barcelona



## 5. Convergence and open research topics



- **Technical/research open topics** (cont'd)
- **Identified by OEC Initiative**
- ETSI ISG MEC to continue work on
  - Requirements for MEC , Edge arch. focusing on mobile BS
  - Standard API's for telecom related edge applications
- **Current Gaps:**
  - **Customer Facing Service**
  - **mobile edge system level management**
    - **Mobile edge orchestration, OSS Operations Support System**
    - **User application life cycle management proxy**
  - **mobile edge host**
    - Deployment model [one instance per /user or host or edge] – topology, cost etc.
    - Latency and location requirements
    - connectivity or mobility requirements (e.g. app. state relocation, app. instance relocation);
  - **mobile edge platform**
    - offering an environment where the mobile edge applications can discover, advertise, consume and offer mobile edge services
    - receiving traffic rules from the mobile edge platform manager, apps., or services, and instructing the data plane accordingly
    - hosting mobile edge services
    - providing access to persistent storage and time of day information

ComputationWorld 2018 Conference February 18, 2018, Barcelona



## 5. Convergence and open research topics



- **Technical/research open topics**
- **Identified by OEC Initiative (cont'd)**
  - **Mobile edge platform management**
    - managing the life cycle of applications including informing the mobile edge orchestrator of relevant application related events;
    - providing element management functions (site, cluster, fog) to the mobile edge platform;
    - managing the application rules and requirements including service authorisations, traffic rules, DNS configuration and resolving conflicts.



# CONTENTS



1. Introduction
2. Multi-access Edge Computing
3. Fog Computing
4. Cloudlets
5. Convergence and Open research topics
6.  **Conclusions**



## 6. Conclusions



- **Edge oriented computing: FC, MEC, Cloudlets share a similar vision**
  
- **Main domains of applications and fields are similar**
  - Internet of Things,
  - Internet of Everything (including industrial applications)
  - Smart cities
  - Tactile Internet, and existence of appropriate wireless connectivity ( low data rate minimal power consumption at a device)
  - 5G networks , 5G slicing and related services
  - Big data with near real-time response
  
- **Centralised CC no more can alone to satisfy novel challenging requirements of a distributed world → extension of cloud computing to the edge of networks.**
  
- Many players have recognized this, as seen in the existence of concepts like
  - **Fog Computing, Mobile Edge Computing and Cloudlets, Open Edge Computing.**



## 6. Conclusions



- For the time being - the trend is less supported less by big public cloud providers like HP, IBM, Google, Microsoft, or Amazon.
- However, cooperation Cloud- Middleware – devices seems to be the best tradeoffs to take benefit of powerful CC and also solve the scalability, real-time and bandwidth problems of a lot of applications
- **FC, MEC, Cloudlet** approaches can well serve and play a role in specific domain of Future Internet and especially in IoT, IoE, ...:
  - Connected vehicles, V2V, V2X. Automotive safety services (traffic ncontrol, ice on motorway real-time warning, platooning, coordinated lane change manoeuvres etc.)
  - Services in infotainment (e.g. in automotive)
  - Safety and emergency systems
  - Mission critical systems



## 6. Conclusions



- **Smart city** system components like smart traffic lights (beyond what's available today)
- **Big data and analytics** for sectors like industrial: real-time analytics at the edge, long-term analytics in the main cloud, for purposes like predictive maintenance and others.
- **Smart grid**, closed loop system (a degree of central processing occurs at the edge with special requirements on stability and rapid response).
- Efficient operation of **wind farms**: semi-autonomous controllers at each wind turbine are orchestrated on the level of the wind farm by software at the edge
- **Robotics for various sectors** including assisted living, remote diagnostics etc.
- Any sector that makes use of **wireless sensor systems**, (e.g. oil & gas or building industry)
  
- **Convergence of architectures is expected**





- Thank you !
- Questions?



# List of Acronyms



■	ACE	Ancestral Communication Entity
■	AVC	Audio Video Conference
■	BBU	Baseband Processing Unit
■	BS	Base Station
■	BSC	Base Station Controller (2G/3G)
■	BSS	Business Support System
■	CC	Cloud Computing
■	CCN	Content Centric Networking
■	CDN	Content Delivery Network
■	COTS	Commercial-off-the-Shelf
■	CP	Content Provider
■	CRAN	Cloud RAN
■	EC	Edge Computing
■	EPC	Evolved Packet Core
■	ETSI	European Telecommunications Standards Institute
■	FC	Fog Computing
■	FCN	Fog Computing Node
■	HPN	High Power Node
■	HTTP	Hyper Text Transport Protocol
■	IaaS	Infrastructure as a Service
■	IMS	IP Multimedia System
■	ISG	Industry Specification Group.
■	IT	Information Technology
■	KVM	Kernel-based Virtual Machine
■	LTE	Long Term Evolution
■	MEC	Mobile Edge Computing
■	MBMS	Multicast Broadcast Media Service
■	M&O	Management and Orchestration
■	MME	Mobility Management Entity

ComputationWorld 2018 Conference February 18, 2018, Barcelona



## List of Acronyms (cont'd)



- NF Network Function
- NFV Network Functions Virtualization
- NFVI Network Functions Virtualization Infrastructure
- NO Network Operator
- NP Network Provider
- NS Network Service
- OEC Open Edge Computing
- OSS Operations Support System
- OSPF Open Shortest Path First
- PaaS Platform as a Service
- PoC Proof of Concept
- RAN Radio Access Network
- RRH Remote Radio Head
- RNC Radio Network Controller
- QEMU Quick Emulator
- SaaS Software as a Service
- SDN Software Defined Network
- SLA Service Level Agreement
- S/P-GW Serving and Packet Data Networks Gateway
- SP Service Provider
- TCP Transmission Control Protocol
- UDP User Datagram Protocol
- VM Virtual Machine
- VNF Virtual Network Function



# References-1



1. F.Bonomi, R.Milito, J.Zhu, and S.Addepalli, "Fog computing and its role in the Internet of Things," in ACM SIGCOMM Workshop on Mobile cloud Computing, Helsinki, Finland, 2012, pp. 13--16.
2. F.Bonomi, R.Milito, P.Natarajan and J.Zhu, "Fog Computing: A Platform for Internet of Things and Analytics", in N. Bessis and C. Dobre (eds.), "Big Data and Internet of Things": 169 A Roadmap for Smart Environments, Studies in Computational Intelligence 546, Springer Int'l Publishing 2014
3. Sl. Stojmenovic, S.Wen," The Fog Computing Paradigm: Scenarios and Security Issues, Proc. of the 2014 Federated Conf. on Computer Science and Information Systems pp. 1–8
4. L.M. Vaquero, L.Rodero-Merino, "Finding your Way in the Fog: Towards a Comprehensive Definition of Fog Computing", ACM SIGCOMM Computer Comm. Review, Vol. 44, No 5, October 2014
5. M.Patel et al., "Mobile-Edge Computing – Introductory Technical White Paper",  
[https://portal.etsi.org/Portals/0/TBpages/MEC/Docs/Mobile-edge\\_Computing\\_-\\_Introductory\\_Technical\\_White\\_Paper\\_V1%2018-09-14.pdf](https://portal.etsi.org/Portals/0/TBpages/MEC/Docs/Mobile-edge_Computing_-_Introductory_Technical_White_Paper_V1%2018-09-14.pdf)
6. "Mobile edge computing (MEC): Terminology," ETSI, Sophia Antipolis, France, Mar. 2016. [Online]. Available: [http://www.etsi.org/deliver/etsi\\_gs/MEC/001\\_099/001/01.01.01\\_60/gs\\_MEC001v010101p.pdf](http://www.etsi.org/deliver/etsi_gs/MEC/001_099/001/01.01.01_60/gs_MEC001v010101p.pdf)
7. "Mobile edge computing (MEC); Framework and reference architecture," ETSI, Sophia Antipolis, France, Mar. 2016. [Online]. Available: [http://www.etsi.org/deliver/etsi\\_gs/MEC/001\\_099/003/01.01.01\\_60/gs\\_MEC003v010101p.pdf](http://www.etsi.org/deliver/etsi_gs/MEC/001_099/003/01.01.01_60/gs_MEC003v010101p.pdf)
8. Cloudlets: all about cloudlet-enabled mobile computing. <http://elijah.cs.cmu.edu/>
9. M.Satyanarayanan, et.al., "Cloudlets: at the Leading Edge of Mobile-Cloud Convergence", 2014 6th International Conference on Mobile Computing, Applications and Services (MobiCASE)[http://ieeexplore.ieee.org/xpls/abs\\_all.jsp?arnumber=7026272](http://ieeexplore.ieee.org/xpls/abs_all.jsp?arnumber=7026272)
10. Victor Bahl, " Microsoft, interview about micro datacentres", Sept 2015.  
<http://www.networkworld.com/article/2979570/cloud-computing/microsoft-researcher-why-micro-datacenters-really-matter-to-mobiles-future.html>
11. \*\*\* OpenFog Architecture Overview, OpenFog Consortium Architecture Working Group, 2016  
[www.OpenFogConsortium.org](http://www.OpenFogConsortium.org)
12. \*\*\* OpenFog Reference Architecture for Fog Computing, February 2017, OpenFog Consortium Architecture Working Group, [www.OpenFogConsortium.org](http://www.OpenFogConsortium.org)
13. M.Iorga et. al., NIST Special Publication 800-191 (Draft) 1, "The NIST Definition of Fog Computing", 2017
14. "Innovations in Edge Computing and MEC (Latest in Multi-access Edge Computing, Fog Computing, Distributed Clouds)", 2017, <http://www.linkedin.com/in/kmsabidurrahman/>



## References-2



15. \*\*\* “Fog vs Edge Computing”, <https://www.nebbiolo.tech/wp-content/uploads/whitepaper-fog-vs-edge.pdf>
16. \*\*\* “Fog Computing: Keystone of Industrial IoT and Industry 4.0”, <https://www.fogworldcongress.com/conference/agenda/fog-computing-keystone-industry-40>
17. \*\*\* “Cloud, Fog and Edge Computing – What’s the Difference?” <https://www.winsystems.com/cloud-fog-and-edge-computing-whats-the-difference/>
18. C. Mouradian, et.al., “A Comprehensive Survey on Fog Computing: State-of-the-art and Research Challenges”, IEEE Communications Surveys & Tutorials, 2017
19. R.Mahmud and R.Buyya, Fog Computing: A Taxonomy, Survey and Future Directions, arXiv:1611.05539v3 [cs.DC] 24 Nov 2016
20. A.V. Dastjerdi, et.al., “Fog Computing: Principles, Architectures, and Applications”, 2016, Book Chapter in Internet of Things: Principles and Paradigms, <http://arxiv.org/abs/1601.02752>
21. A. Ahmed, E. Ahmed, “A Survey on Mobile Edge Computing”, IEEE, Int’l Conf. on Intelligent System and Control ISCO 2016, <https://www.researchgate.net/publication/285765997>
22. Yun Chao Hu et.al., “Mobile Edge Computing A key technology towards 5G” ETSI , White Paper No. 11 September 2015, ISBN No. 979-10-92620-08-5
23. IETF, Kanugovi et. al., “Multiple Access Management Services”, draft-kanugovi-intarea-mams-framework-00 July 2018
24. P.Mach, Z.Becvar, *Mobile Edge Computing: A Survey on Architecture and Computation Offloading*, arXiv:1702.05309v2 [cs.IT], 13 Mar 2017
25. A. Ksentini, T. Taleb, and M. Chen, “A Markov Decision Process-based Service Migration Procedure for Follow Me Cloud”, IEEE International Conference on Communications (ICC), 1350-54, 2014
26. A.Munir, et.al., “IFCloT: Integrated Fog Cloud IoT Architectural Paradigm for Future Internet of Things”, arXiv:1701.08474v1 [cs.DC] 30 Jan 2017
27. C.C. Byers, Architectural Imperatives for Fog Computing: Use Cases, Requirements, and Architectural Techniques for Fog-Enabled IoT Networks, IEEE Communications Magazine, August 2017, pp.14-20
28. T H. Luan et.; al. , “Fog Computing: Focusing on Mobile Users at the Edge”, arXiv:1502.01815v3 [cs.NI] 30 Mar 2016
29. K.P.Saharan, A.Kumar “ Fog in Comparison to Cloud: A Survey”, *Int’l. Journal of Computer Applications* (0975 – 8887) Volume 122 – No.3, July 2015



## References-3



30. M. Chiang, "Fog Networking: An Overview on Research Opportunities", December 2015, <https://arxiv.org/ftp/arxiv/papers/1601/1601.00835.pdf>
31. B.Tang, et.al., „A hierarchical distributed fog computing architecture for big data analysis in smart cities”, ASE BD&SI 2015, October 07-09, 2015, Kaohsiung, Taiwan, ACM, <https://www.researchgate.net/publication/281287012>, ISBN 978-1-4503-3735-9
32. Shanhe Yi, et.al., “Fog Computing: Platform and Applications”, 2015 Third IEEE Workshop on Hot Topics in Web Systems and Technologies, <https://www.computer.org/csdl/proceedings/hotweb/2015/9688/00/9688a073.pdf>
33. White Paper, “Cisco Fog Computing Solutions: Unleash the Power of the Internet of Things”, [https://www.cisco.com/c/dam/en\\_us/solutions/trends/iot/docs/computing-solutions.pdf](https://www.cisco.com/c/dam/en_us/solutions/trends/iot/docs/computing-solutions.pdf)
34. *Open- Stack++* (<http://elijah.cs.cmu.edu>)
35. *Cloudlets: all about cloudlet-enabled mobile computing.* <http://elijah.cs.cmu.edu/>
36. <http://openedgecomputing.org/about-oec.html>
37. R.Schuster, P. Ramchandran, OPEN EDGE COMPUTING - FROM VISION TO REALITY -2016 OPNFV Design Summit, Berlin, Germany
38. Panwar N., Sharma S., Singh A. K. ‘A Survey on 5G: The Next Generation of Mobile Communication’. Accepted in Elsevier Physical Communication, 4 Nov 2015, <http://arxiv.org/pdf/1511.01643v1.pdf>
39. Agyapong P.K., Iwamura M., Staehle D., Kiess W., Benjebbour A. ‘Design Considerations for a 5G Network Architecture’. IEEE Communications Magazine, November 2014, pp. 65-75
40. 5G Vision, 2015, [www.5g-ppp.eu](http://www.5g-ppp.eu)
41. Understanding 5G: Perspectives on future technological advancements in mobile, 2014, <https://gsmaintelligence.com/research/?file=141208-5g.pdf&download>
42. M.Peng,S.Yan, K.Zhang, and C.Wang, "Fog Computing based Radio Access Networks:Issues and Challenges", IEEE NETWORK,2015, <http://arxiv.org/abs/1506.04233>
43. Guenter I. Klas “Fog Computing and Mobile Edge Cloud Gain Momentum”, Open Fog Consortium, ETSI MEC and Cloudlets , Version 1.1 Nov 22, 2015
44. K.P.Saharan , A.Kumar “ Fog in Comparison to Cloud: A Survey”, Int’l. Journal of Computer Applications (0975 – 8887) Volume 122 – No.3, July 2015
45. Hung S.C, Hsu H. Lien S.Y., ChenK.C. ‘Architecture Harmonization Between Cloud Radio Access Networks and Fog Networks’. IEEE Access, December 2015. Available from [http://ieeexplore.ieee.org/xpls/abs\\_all.jsp?arnumber=7359093](http://ieeexplore.ieee.org/xpls/abs_all.jsp?arnumber=7359093)

ComputationWorld 2018 Conference February 18, 2018, Barcelona



## References-4



46. M.Satyanarayanan, et. al., “An Open Ecosystem for Mobile-Cloud Convergence”, IEEE Communications Magazine , March 2015, pp.63-70
47. M. Satyanarayanan *et al.*, “The Case for VM-Based Cloudlets in Mobile Computing,” *IEEE Pervasive Computing*, vol. 8, no. 4, Oct.–Dec. 2009.
48. <http://openedgecomputing.org/about-oec.html>
49. “Cisco Fog Computing Solutions: Unleash the Power of the Internet of Things”,[https://www.cisco.com/c/dam/en\\_us/solutions/trends/iot/docs/computing-solutions.pdf](https://www.cisco.com/c/dam/en_us/solutions/trends/iot/docs/computing-solutions.pdf)
50. Frank van Lingen, et.al., “The Unavoidable Convergence of NFV, 5G, and Fog: A Model-Driven Approach to Bridge Cloud and Edge” , IEEE Communications Magazine, August 2017, pp.28-35
51. “YANG — A Data Modeling Language for the Network Configuration Protocol (NETCONF),” IETF RFC 6020; <http://www.rfc-editor.org/rfc/rfc6020.txt>.
52. R. Vilalta, et.al., “TelcoFog: A Unified Flexible Fog and Cloud Computing Architecture for 5G Networks”, IEEE Communications Magazine, August 2017, pp.36-43



- Additional slides



# 1. SDN and NFV cooperation

- **NFV SDN-Cooperation**
- ONF: NFV and SDN – industry view on architecture
- *Source: ONF*

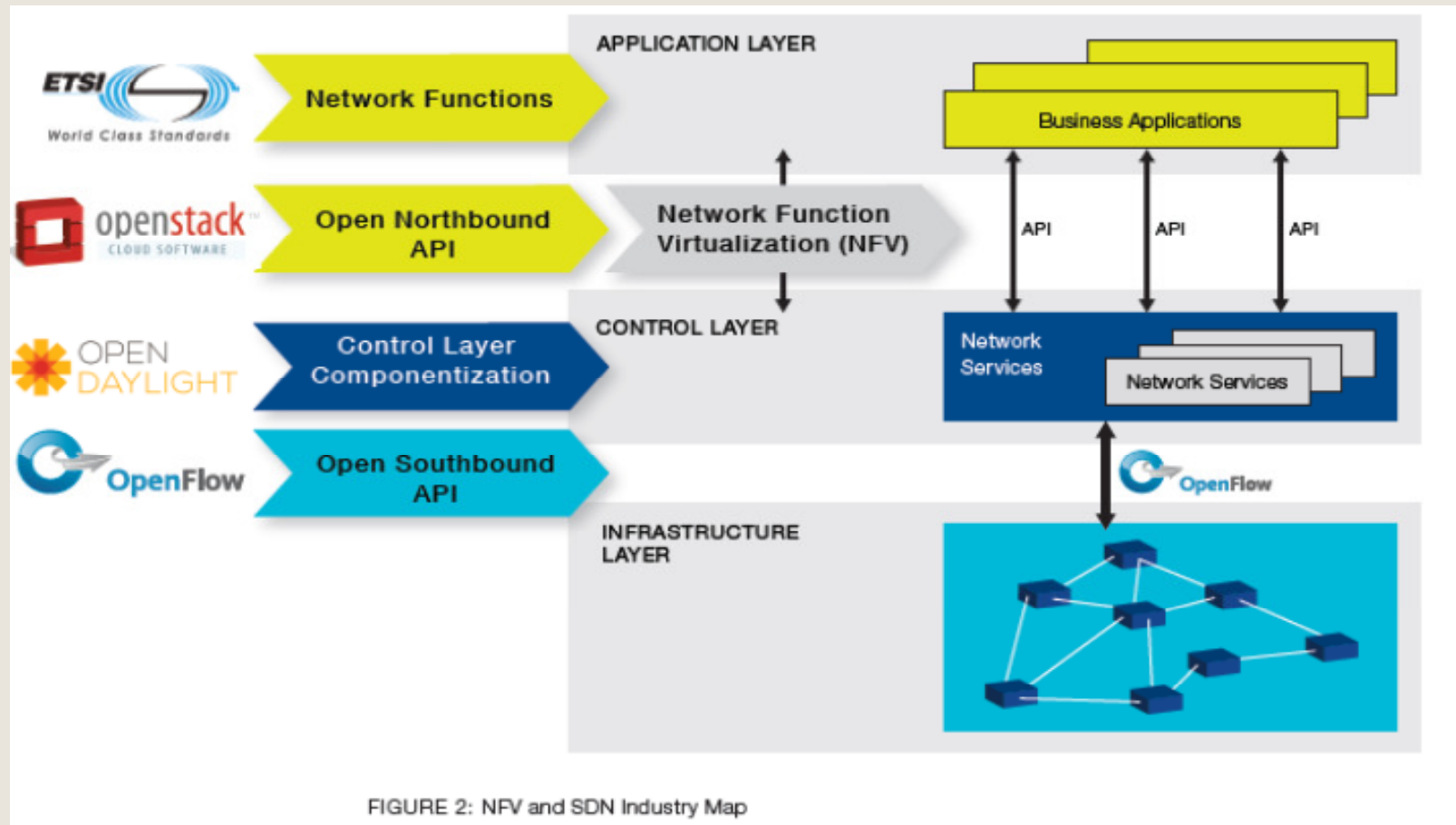

### ■ MEC Use Cases examples ( content- oriented) (cont'd)

#### ■ Video Analytics

- distributed **video analytics solution**: efficient and scalable mobile solution for LTE
- The **video mgmt.** application **transcodes** and **stores captured video** streams from cameras, received on the LTE uplink
- The **video analytics** app. **processes the video data to detect and notify specific configurable events** e.g. object movement, lost child, abandoned luggage, etc.
- The application **sends low bandwidth video metadata** to the **central operations and management server** for database searches. Applications : safety, public security to smart cities

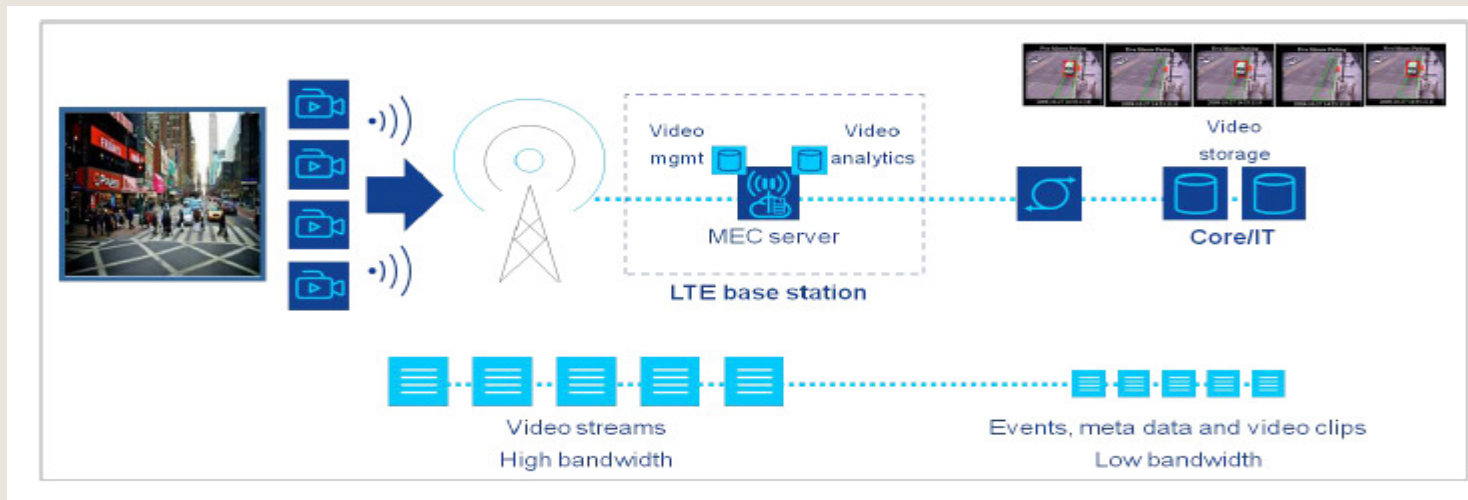

Source [5]: [https://portal.etsi.org/Portals/0/TBpages/MEC/Docs/Mobile-edge\\_Computing\\_-\\_Introductory\\_Technical\\_White\\_Paper\\_V1%2018-09-14.pdf](https://portal.etsi.org/Portals/0/TBpages/MEC/Docs/Mobile-edge_Computing_-_Introductory_Technical_White_Paper_V1%2018-09-14.pdf)

ComputationWorld 2018 Conference February 18, 2018, Barcelona

- **MEC Use Cases examples ( content- oriented) (cont'd)**
  - **Distributed Content and DNS Caching**
    - A distributed caching technology can provide backhaul and transport savings and improved QoE.
    - Content caching could reduce backhaul capacity requirements by ~35%
    - Local DNS caching can reduce web page download time by ~20%

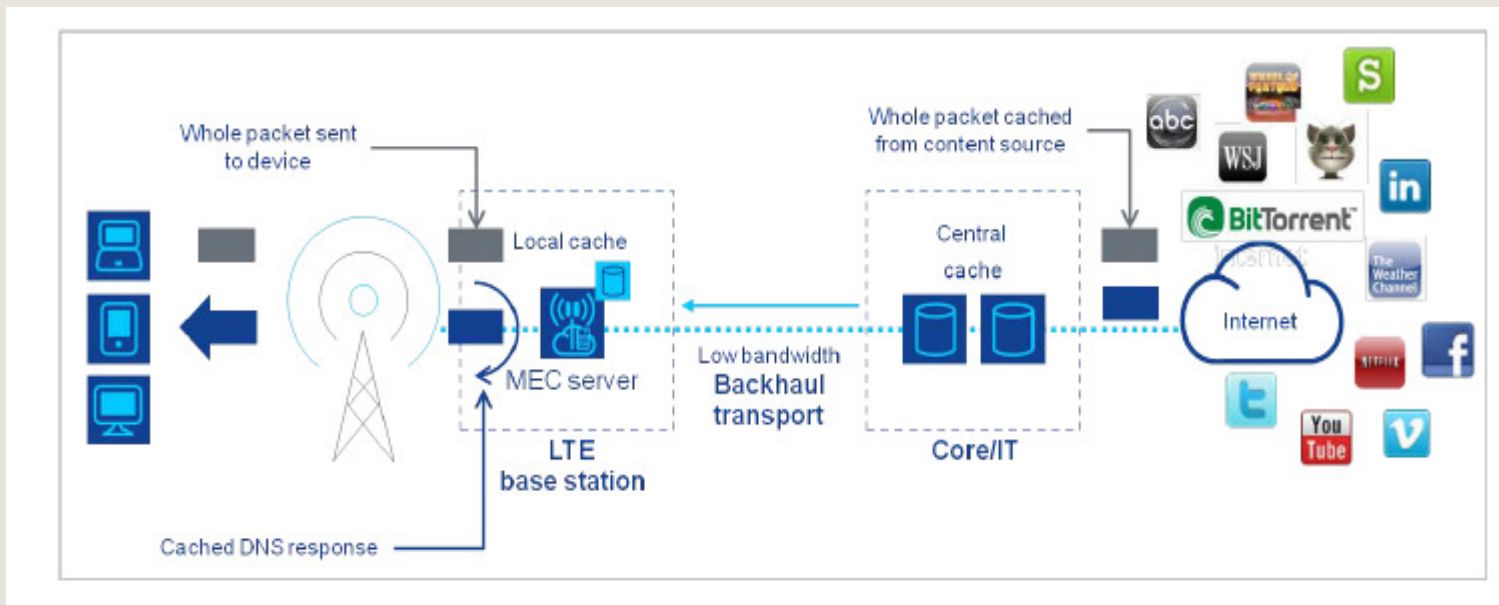

Source [5]: [https://portal.etsi.org/Portals/0/TBpages/MEC/Docs/Mobile-edge\\_Computing\\_-\\_Introductory\\_Technical\\_White\\_Paper\\_V1%2018-09-14.pdf](https://portal.etsi.org/Portals/0/TBpages/MEC/Docs/Mobile-edge_Computing_-_Introductory_Technical_White_Paper_V1%2018-09-14.pdf)

ComputationWorld 2018 Conference February 18, 2018, Barcelona

- **MEC Use Cases examples (content- oriented)**
- **Augmented Reality (AR) content delivery**
  - An AR application on a smart-phone or tablet - overlays augmented reality content onto objects viewed on the device camera
  - Applications on the MEC server can provide local object tracking and local AR content caching;
    - RTT is minimized and throughput is maximized for optimum QoE
    - Use cases: offer consumer or enterprise propositions, such as tourist information, sporting event information, advertisements etc.

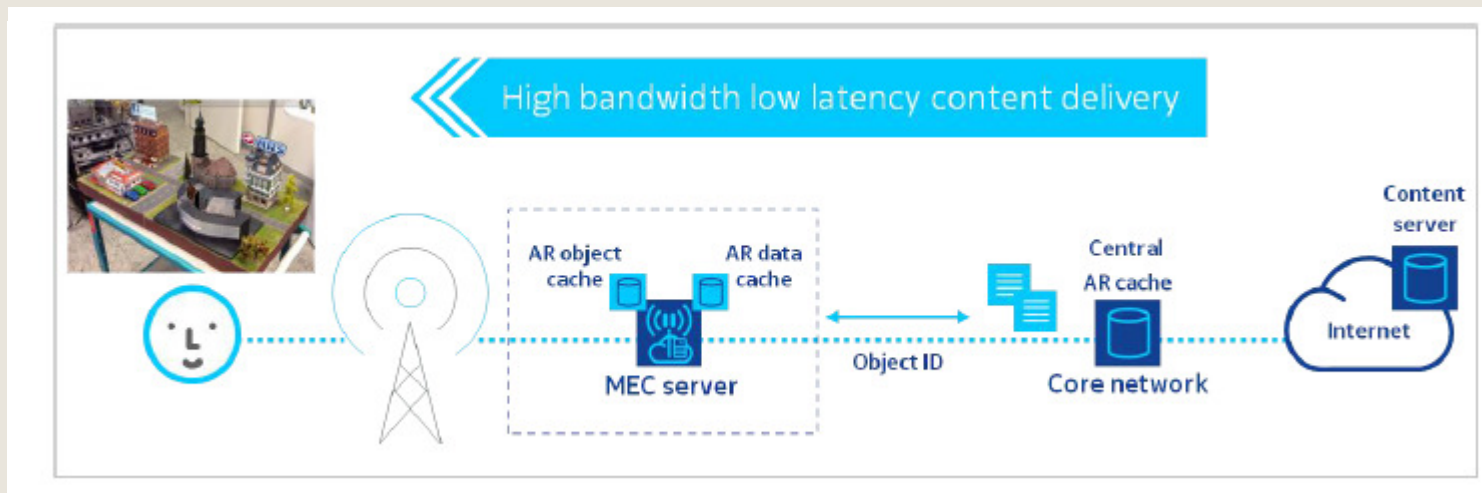

Source [5]: [https://portal.etsi.org/Portals/0/TBpages/MEC/Docs/Mobile-edge\\_Computing\\_-\\_Introductory\\_Technical\\_White\\_Paper\\_V1%2018-09-14.pdf](https://portal.etsi.org/Portals/0/TBpages/MEC/Docs/Mobile-edge_Computing_-_Introductory_Technical_White_Paper_V1%2018-09-14.pdf)

ComputationWorld 2018 Conference February 18, 2018, Barcelona

## 2. Multi-access Edge Computing

- **MEC Use Cases examples**
- **Application-aware cell performance optimization**
  - Applied for each device in real time can improve network efficiency and customer experience
  - It can reduce video stalling and increase browsing throughput
  - Reduce latency
  - Provide independent metrics on application performance (video stalls, browsing throughput, and latency) for enhanced network management and reporting

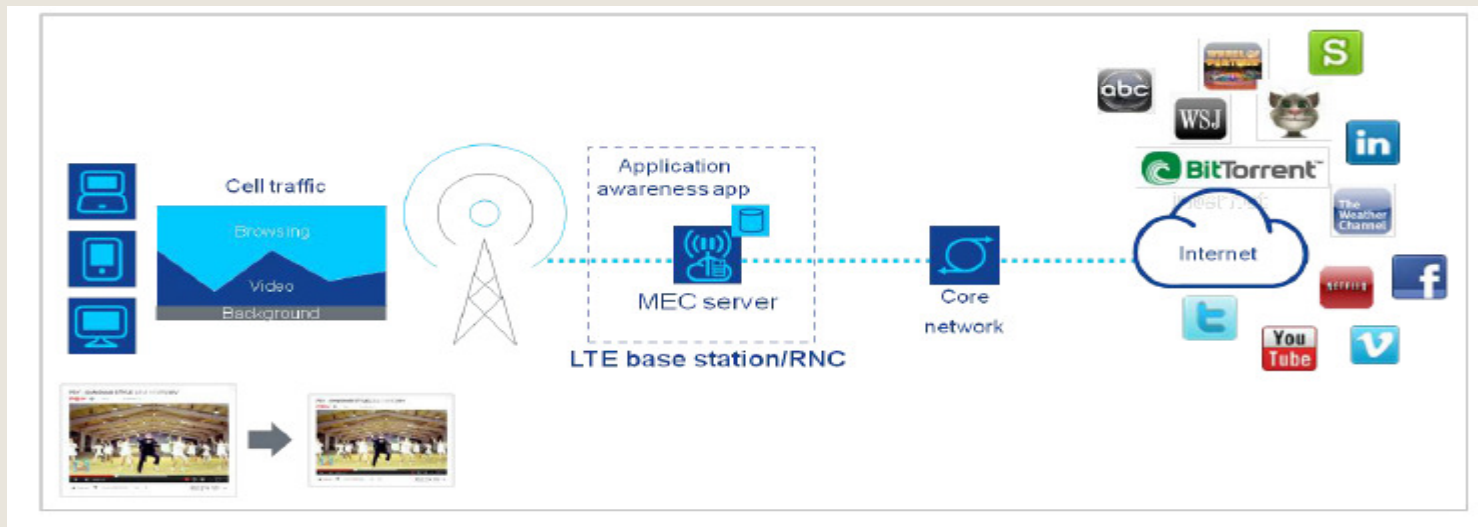

Source[5]: [https://portal.etsi.org/Portals/0/TBpages/MEC/Docs/Mobile-edge\\_Computing\\_-\\_Introductory\\_Technical\\_White\\_Paper\\_V1%2018-09-14.pdf](https://portal.etsi.org/Portals/0/TBpages/MEC/Docs/Mobile-edge_Computing_-_Introductory_Technical_White_Paper_V1%2018-09-14.pdf)

ComputationWorld 2018 Conference February 18, 2018, Barcelona

- Another view of Fog Computing architecture

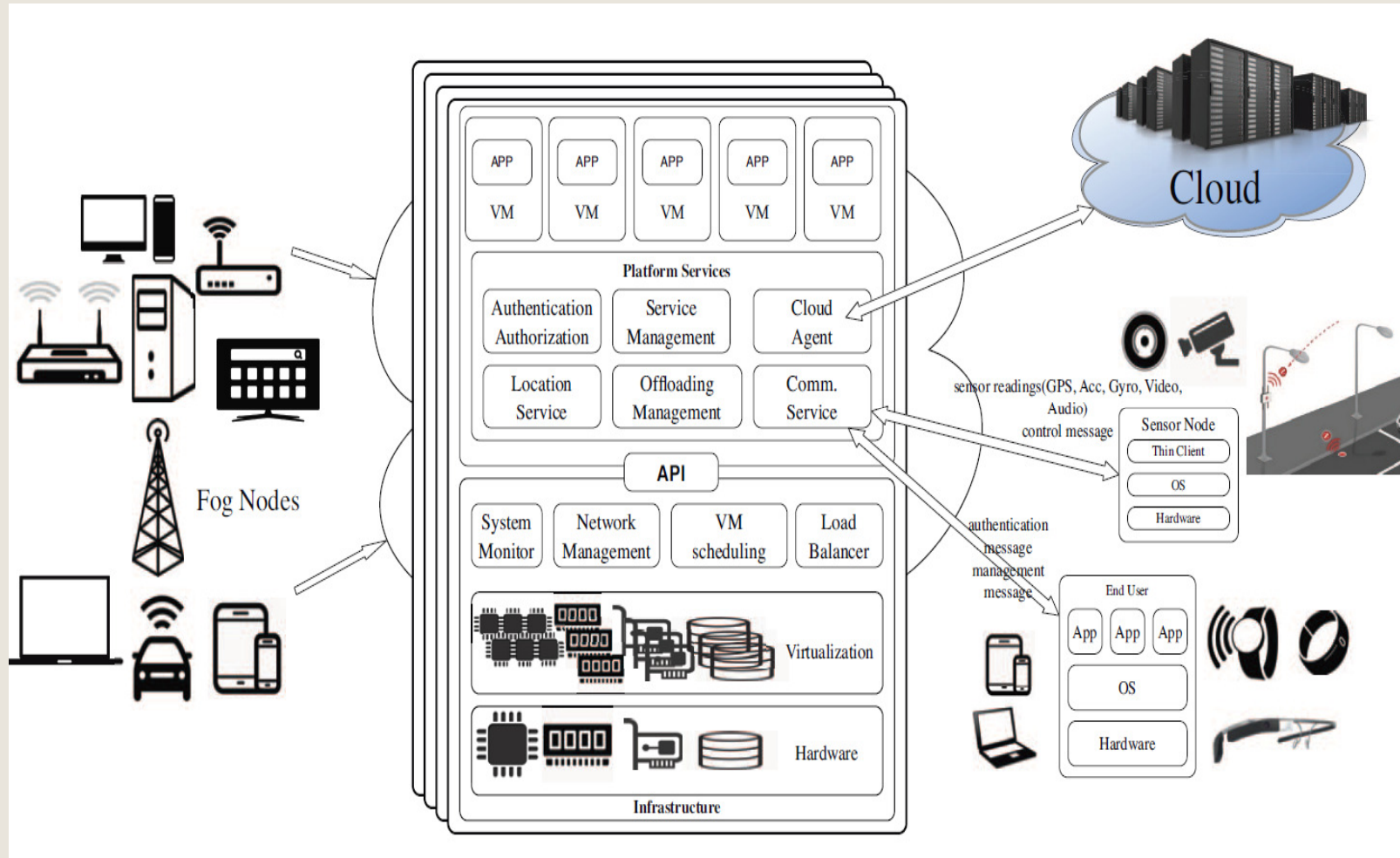

Source [32]: Shanhe Yi, et.al., "Fog Computing: Platform and Applications", 2015 Third IEEE Workshop on Hot Topics in Web Systems and Technologies, <https://www.computer.org/csdl/proceedings/hotweb/2015/9688/00/9688a073.pdf>

ComputationWorld 2018 Conference February 18, 2018, Barcelona