

Université d'Ottawa | University of Ottawa

Miodrag Bolic
Associate Professor
School of Electrical Engineering and
Computer Science (EECS)
Faculty of Engineering
University of Ottawa

Contactless Monitoring of People



uOttawa

www.uOttawa.ca

Some of my research projects

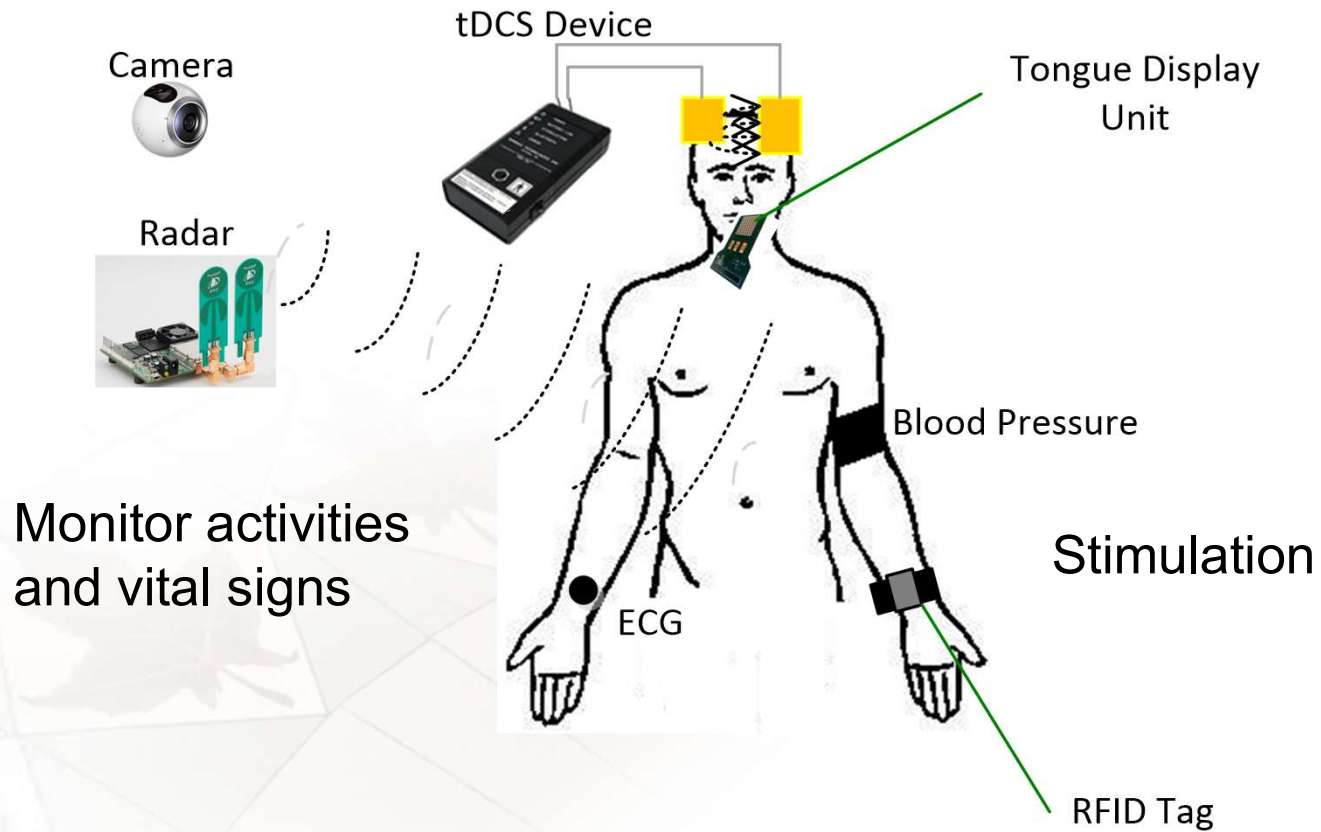

Outline



- Introduction
- Sensors
- What signals can be observed remotely
- Contactless monitoring
 - Radar
 - Camera
- Recent works and future directions

Goal



Continuous, non-invasive
and unobtrusive monitoring of
vital signs and activities
of people



uOttawa

Applications



- Monitoring elderlies and patients
- Sleep apnea
- Preventive monitoring

- Ambient Assisted Living
- Stress and emotion detection
- Detecting social activities and interactions

- Wellness applications



Monitoring seniors



- Problem
 - Seniors don't like or forget to wear wearable devices
- Main goals:
 - Fall detection
 - Fall prevention
 - Estimating level of activities during the day

Life sign monitoring in prisons

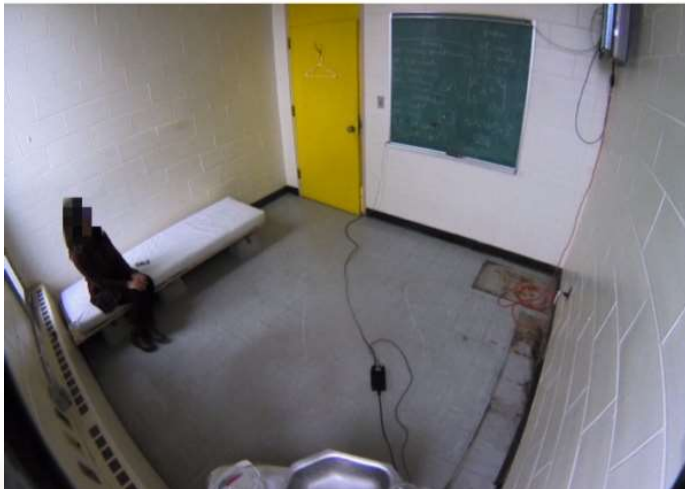

Physiology monitoring and alerting system and process, GE, 20120245479 A1, Sep. 27, 2012.

The system estimates the state of the subject as one of the three states including motion, still and concerned state based on detected motion and physiological parameters



uOttawa

Monitoring Heart Failure patients at home



- Congestive heart failure (CHF) occurs when the heart is unable to pump sufficiently to maintain blood flow to meet the body's needs
- Monitoring heart failure patients to reduce readmission rates
 - In 2015 it affected about 40 million people globally
 - 24% of these patients are re-admitted within a year with further decompensated CHF
 - Progress has been made in monitoring breathing patterns
 - irregular or Cheyne-Stokes respiration
 - respiration stability index (RSI)
- Goal: monitoring patients at home and relaying physiological alerts to care providers.

Respiration monitoring



- Respiration monitoring during radiation treatment
 - Measuring breathing rate during cancer radiation treatment
 - Initial experiments performed with a phantom with very encouraging results
 - Benefits: no need to put the breathing belt on the patients.
- Respiration monitoring for obstructive sleep apnea
 - Characterized by repetitive episodes of shallow or paused breathing during sleep, despite the effort to breathe



Outline



- Introduction
- **Sensors**
- What signals can be observed remotely
- Contactless monitoring
 - Radar
 - Camera
- Recent works and future directions



Sensors

- Wearable
 - Contact-based
 - Designed to monitor physiological processes in the human body
- Infrastructure sensors
 - Remote:
 - Radars, cameras
 - Close proximity detection
 - Pressure mats, bed occupancy sensors

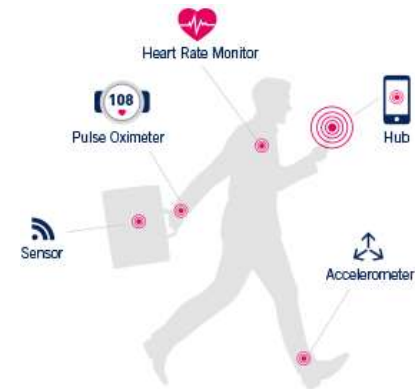

Wearable devices



- Heart rate monitoring
- Breathing rate
- Fall and activity detection

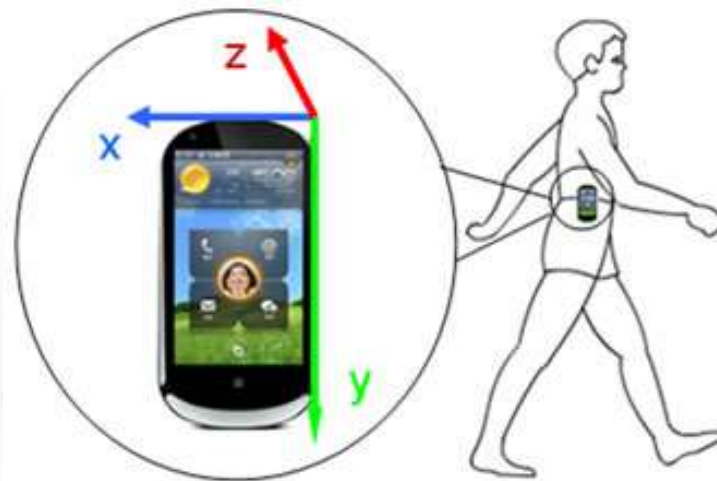

Wearable devices are great, but ...



- Not suitable for monitoring that takes weeks or month
 - You forgot to wear them
 - Or, battery problems
- Or, there are people who do not want to wear sensors
 - Dementia patients
 - People who are not comfortable with new technologies
 - Prisoners

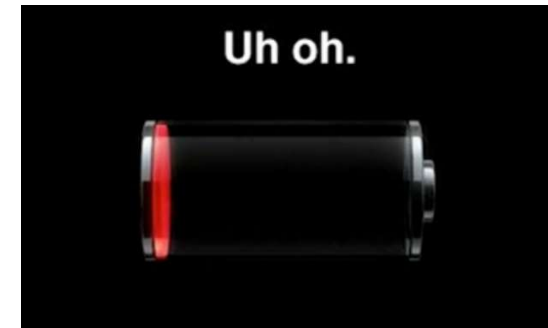

Our focus: Long range contactless monitoring



- Distance of several meters
- Ability to monitor multiple people
- Minimum one sensor, however it is possible to have a network of heterogeneous sensors
- Sensors have to be networked and plugged in because they monitor continuously 24/7
- Monitoring and alarming needs to be performed automatically at the central station

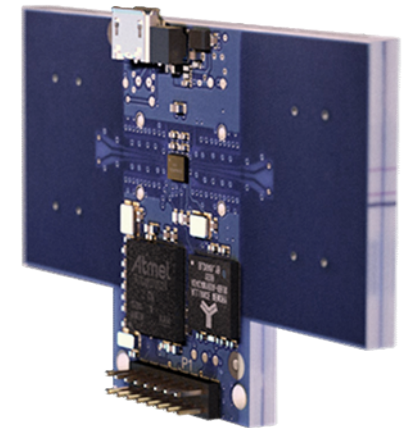

Wearable vs. Contactless Monitoring



	Wearable	Contactless
Interfering with normal behavior		😊
Activating monitoring system		😊
Requiring compliance		😊
Going outside of the range	😊	
Precision	😊	
Environmental problems	😊	

Outline



- Introduction
- Sensors
- **What signals can be observed remotely**
- Contactless monitoring
 - Radar
 - Camera
- Recent works and future Directions



What can we monitor remotely

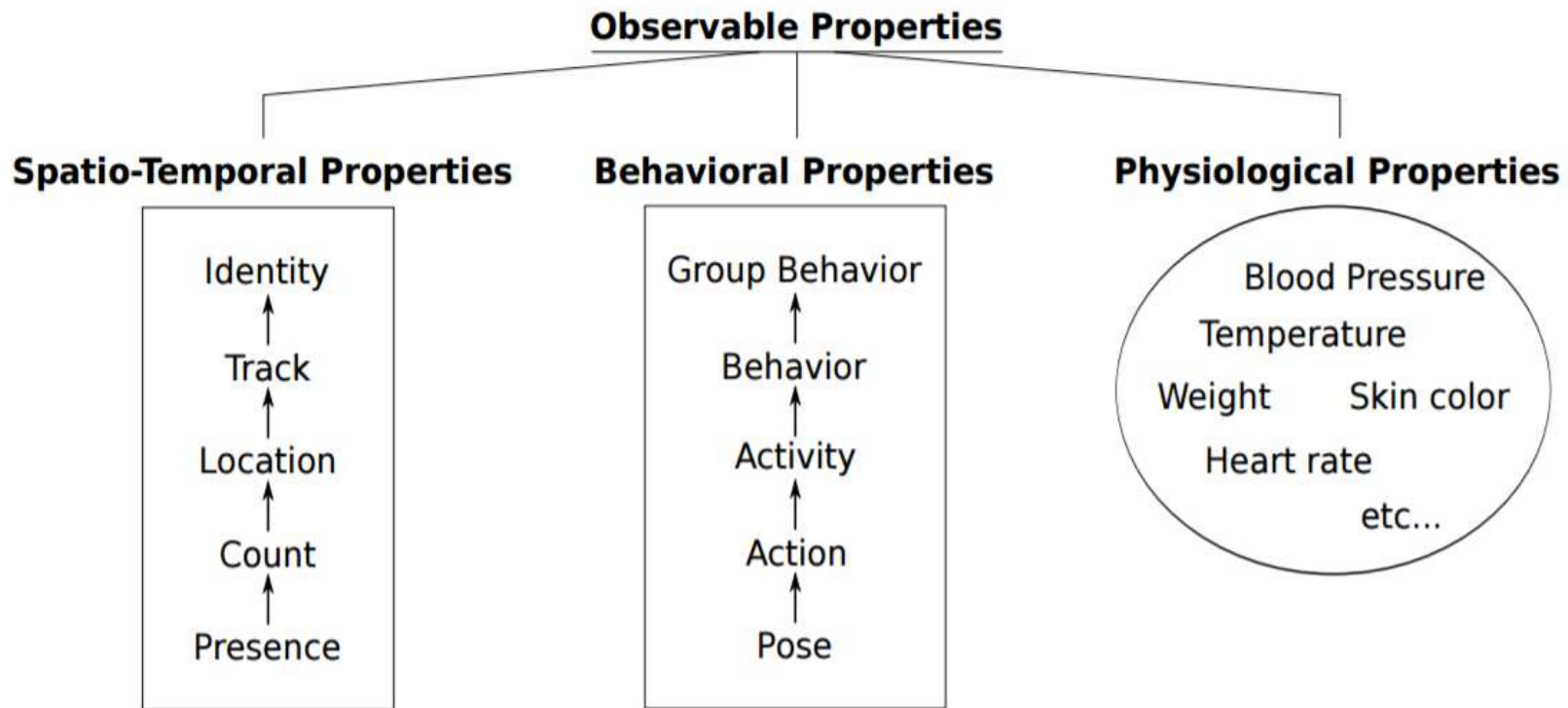

Figure is from Reference [1]: T. Teixeira, et al, "A survey of human-sensing methods for detecting presence, count, location, track and identity," 2015.

Physical traits that can be observed

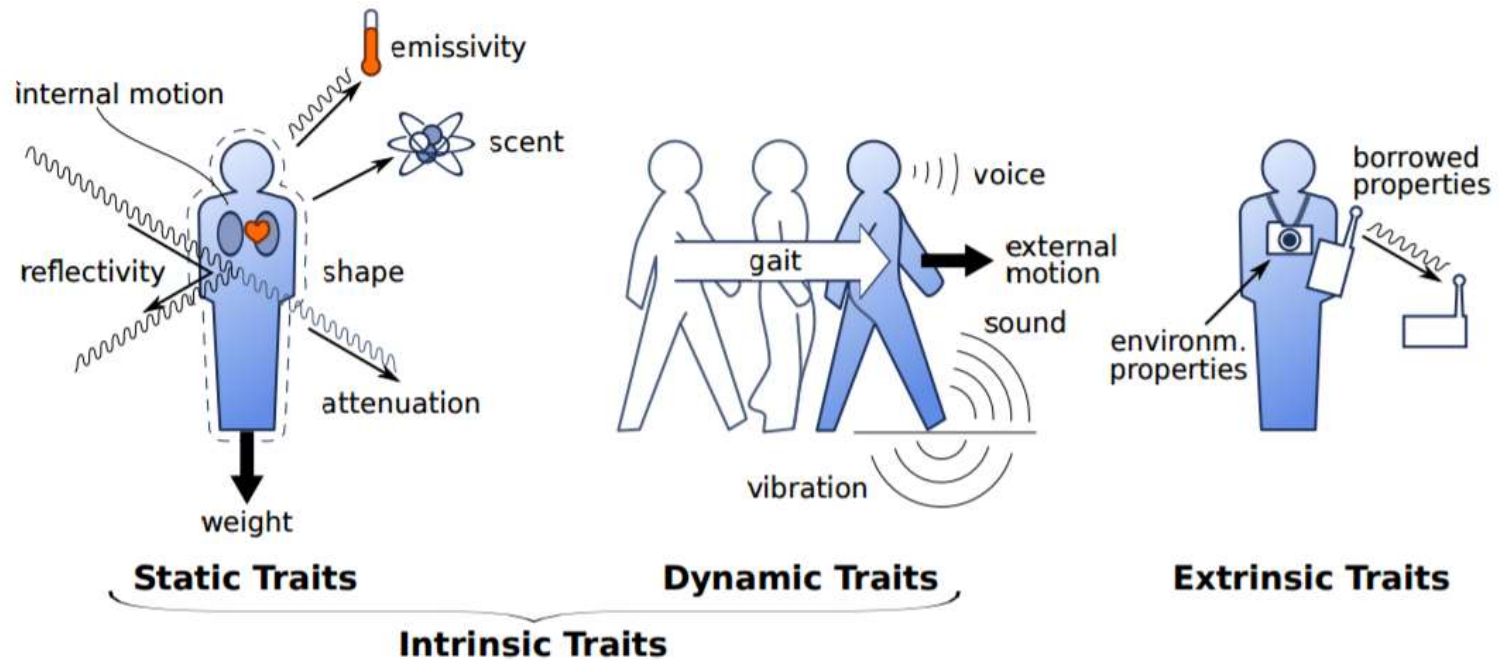

Figure is from Reference [1]: T. Teixeira, et al, "A survey of human-sensing methods for detecting presence, count, location, track and identity," 2015.

Cardiorespiratory contactless monitoring



- Continuous monitoring of the rhythm of heart and lungs
 - Breathing
 - Breathing rate
 - Breathing pattern – repetitive shallow breathing
 - Stop-breathing events
 - Heartbeat
 - Heart rate
 - Heart rate variability
 - Pulse transit time

Cardiorespiratory contactless monitoring techniques

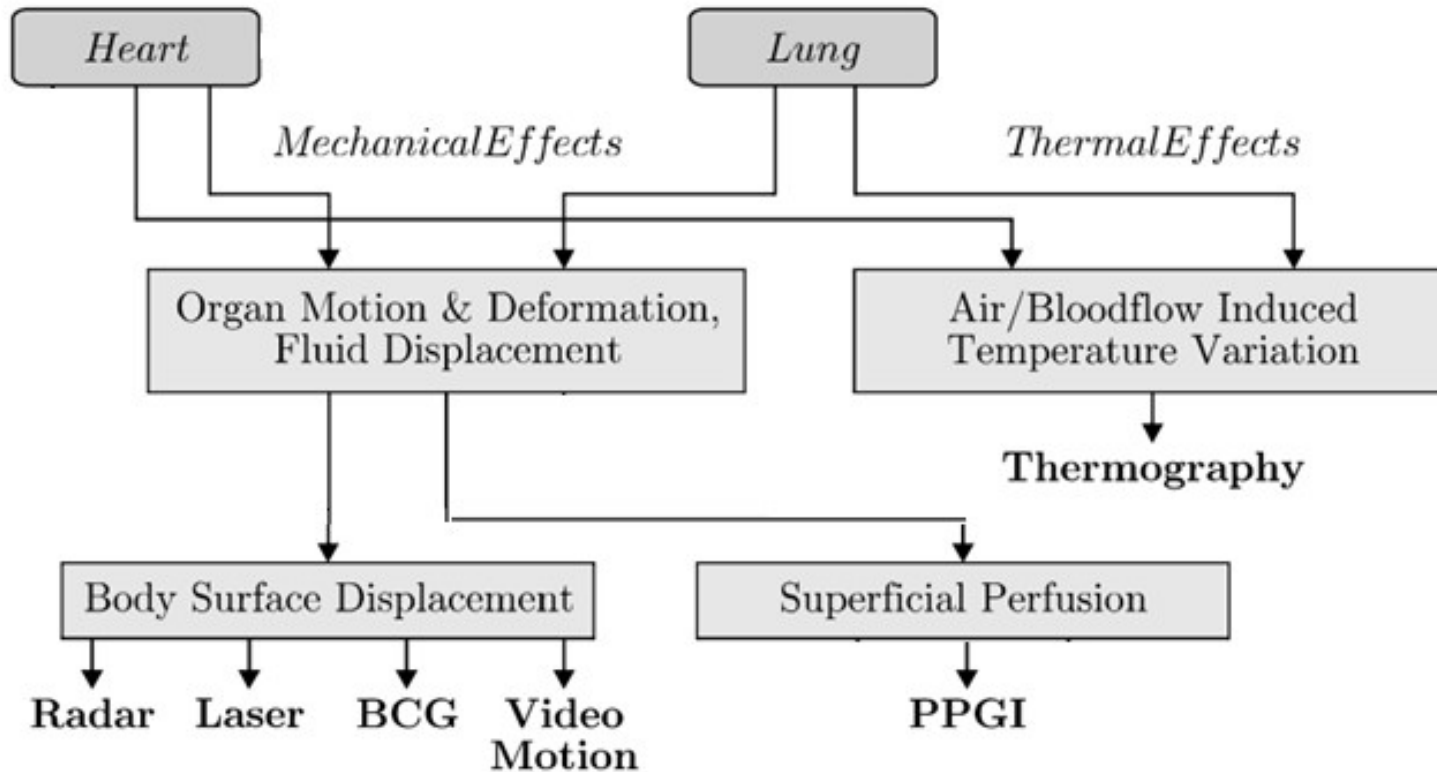

Figure is modified from the Reference [2]: C. Bruser et al. "Ambient and Unobtrusive Cardiorespiratory Monitoring Techniques," 2015.

Outline



- Introduction
- Sensors
- What signals can be observed remotely
- Contactless monitoring
 - Radar
 - Camera
- Recent works and future directions



Challenges



- Signal of interest is often very small
- Signal is extracted in uncontrolled situations
 - E.g. trying to extract the heart rate when the subject is not oriented towards the camera or when the subject is covered.
- Environmental problems
 - Cameras: darkness, background is similar to the object that we want to monitor
 - Radar: clutter, movement at frequencies that correspond to breathing frequencies
- Distance, sensor positions, number of monitored people, cost

Biomedical radar

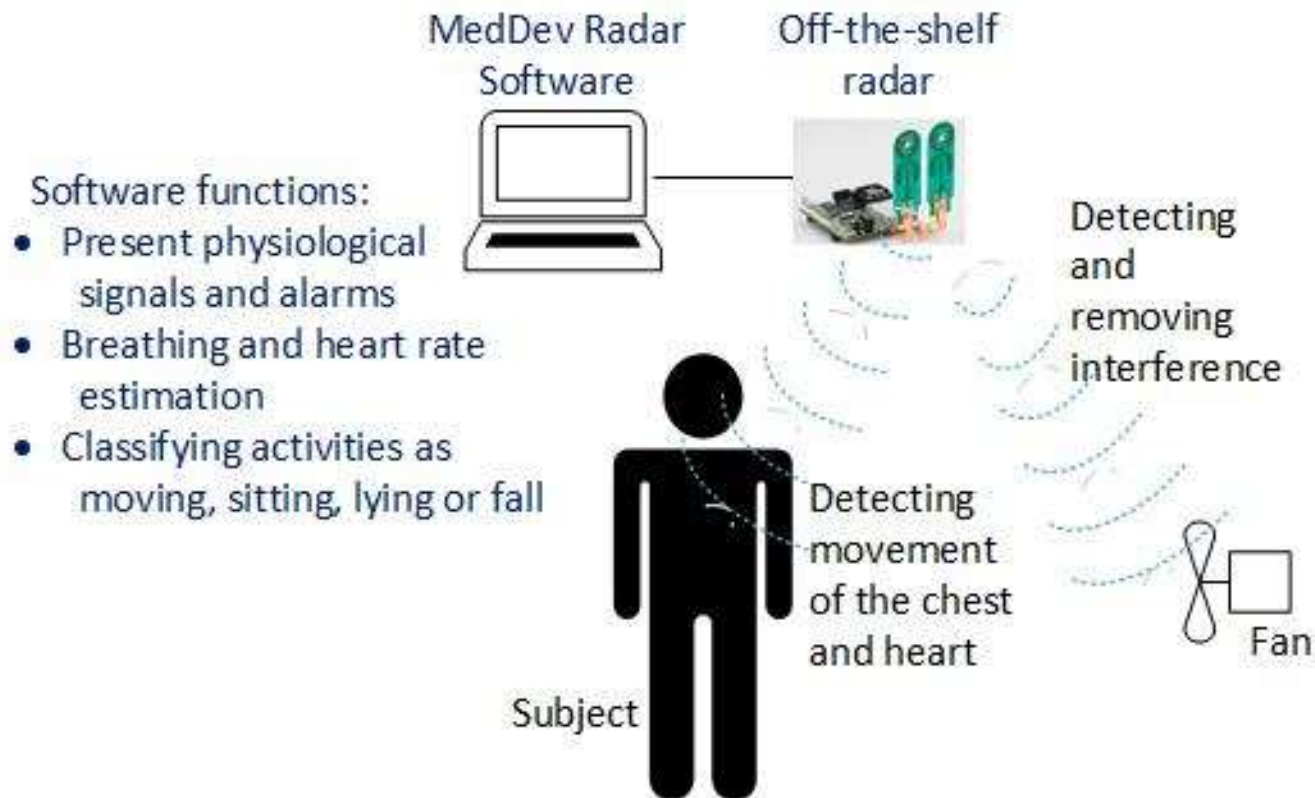

Operation at the system level

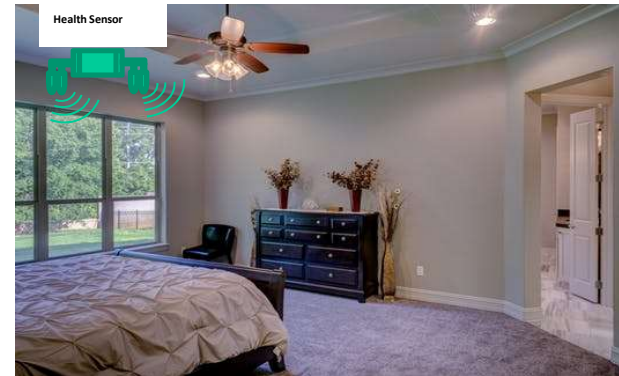
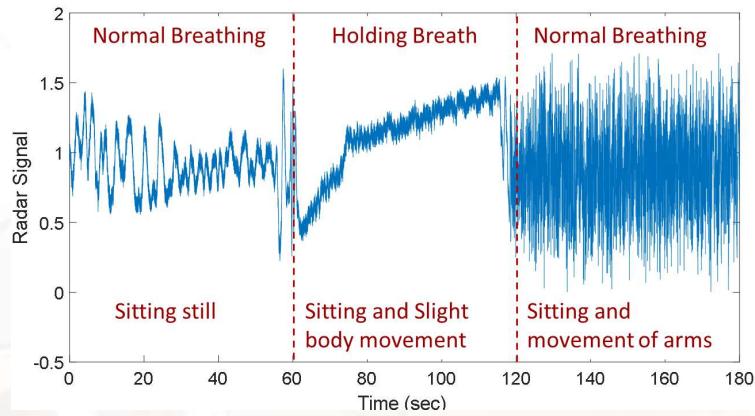
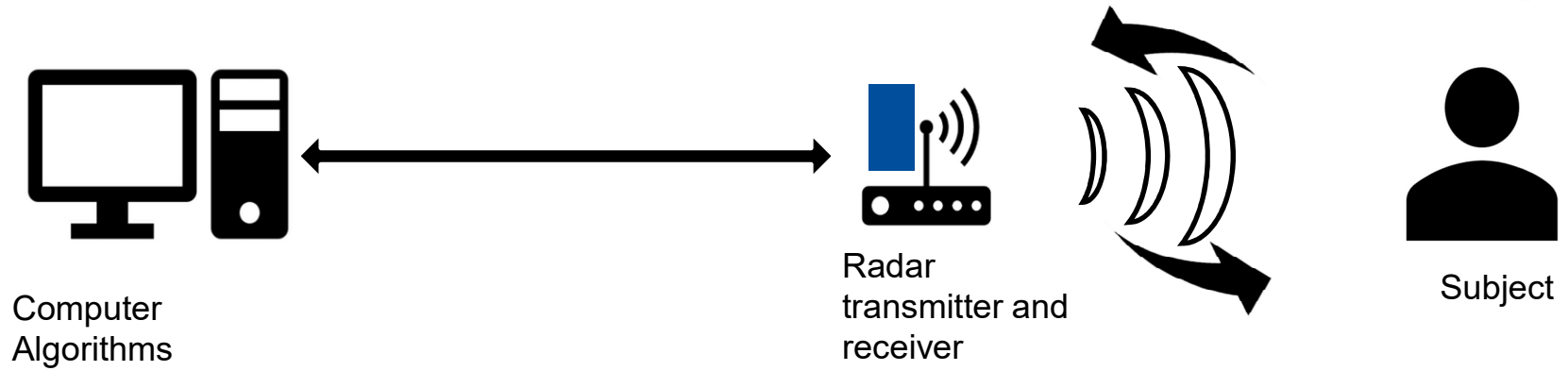

Principles of operations

Two major types of radars:

- Continuous wave
- Pulsed (ultra wide band)

Doppler shift

- Waves reflected from the moving objects will suffer a frequency shift
- The shift is related to the object's velocity towards or away from the radar

Micro-Doppler

- Small-periodic movements

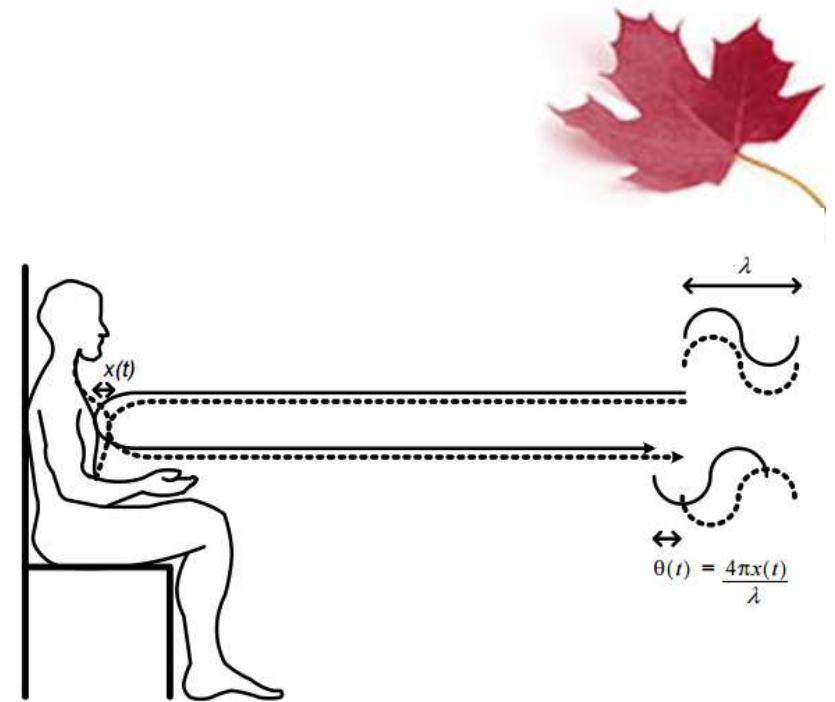

Figure is from the Reference [3]: Droitcour, Amy Diane. *Non-contact measurement of heart and respiration rates with a single-chip microwave Doppler radar*. Diss. Stanford University, 2006.



uOttawa

Biomedical Radar - Applications



- Detection of stop-breathing events
 - Sudden cardiac death
 - Suicide events
- Detection of posture
 - Fallen people
- Detection of activities of people
- Sleep apnea detection
- Other applications
 - Rescue missions under rubble
 - Through-the-wall detection
 - Surveillance applications
 - Detection of the level of stress
 - Road safety in cars
 - Occupancy sensors
 - Human computer interaction through gesture identification

Biomedical Radar - Experiments Ranging and Detection of breathing

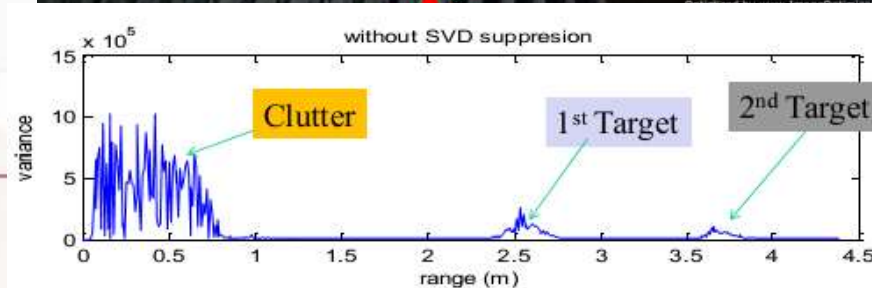
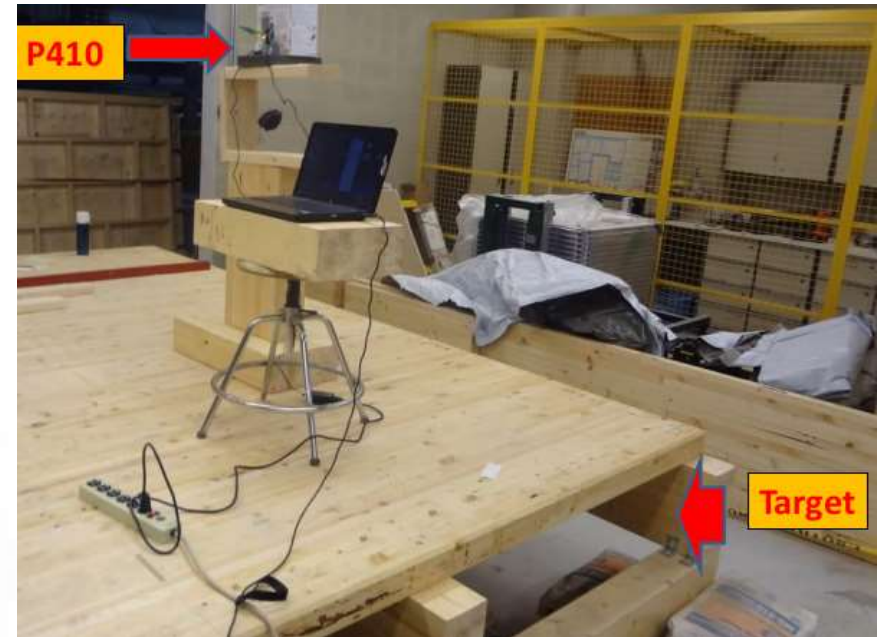
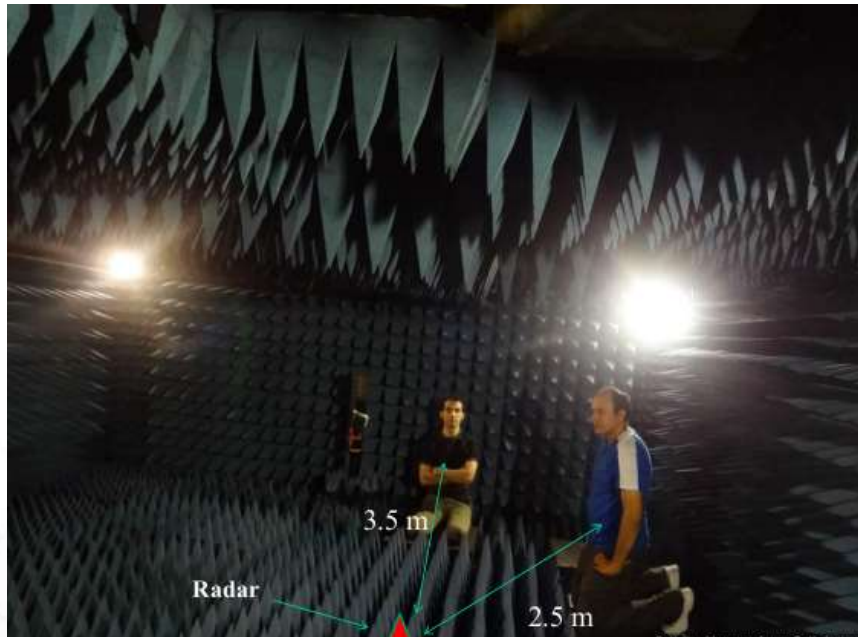

High level processing of radar signals



- Detecting the person
 - Energy of the signal
 - Looking at the probability distribution of the signal over time
- Locating the person
- Classifying the activity of the person
 - Supervised learning
- Breathing estimation
- Posture and fall detection
- Alarm generation

Classification of activities for 9 cases



- 1- Sitting on a chair as still as possible while breathing normally
- 2- Sitting on the chair and randomly moving the head
- 3- Sitting on the chair and randomly moving the torso.
- 4- **Sitting on the chair as still as possible while stop breathing for 20 seconds in every minute.**
- 5- *Sitting on the chair as still as possible while breathing normally with water movement .*
- 6- *Sitting on the chair as still as possible while breathing normally with fan on. A fan was placed in front of the subject and was set to medium speed.*
- 7- *No subject in the room with water movement. The water movement was simulated as in the Event #5.*
- 8- *No subject in the room with fan on. The fan was set as in the Event #6.*
- 9- No subject in the room.

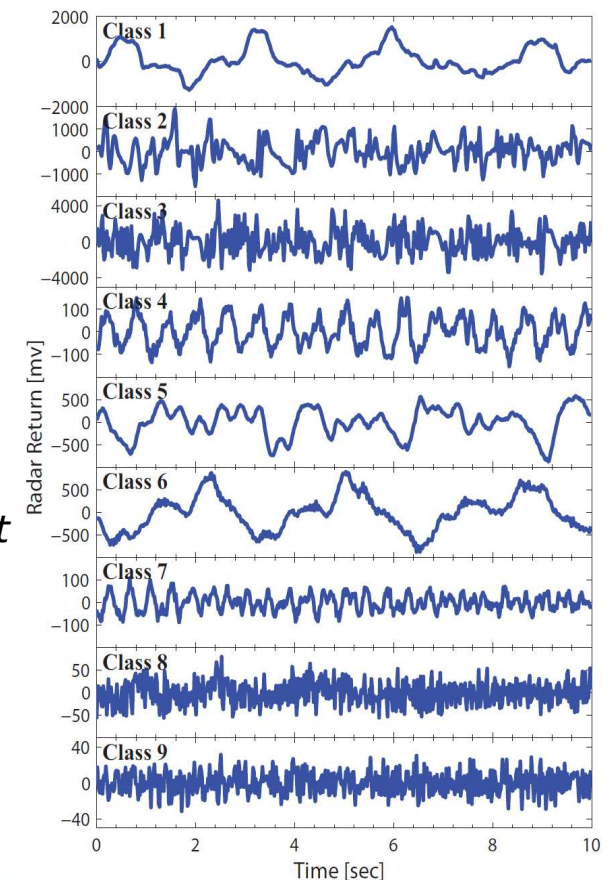

Classification of activities for 9 cases



	Stationary detection	Stop-breathing detection	Interference detection
Linear Bayesian Radar Pattern Classifier			
Accuracy	93.06%	89.47%	86.30%
Sensitivity	94.08%	88.24%	85.00%
Specificity	91.40%	90.68%	87.21%



Data Quality



- Unsupervised data collection, motion artifacts
- Quality of the data being recorded and processed:
 - Raw data quality: identify and quantify noise, artifacts, activities ...
 - Data aggregation quality: data fusion
 - Location quality: position, body posture, etc.
 - Quality of the estimated: your heartrate is higher than usual.
- Requires data quality indicators and uncertainty quantification

Confidence intervals for estimated breathing rate from the radar signal

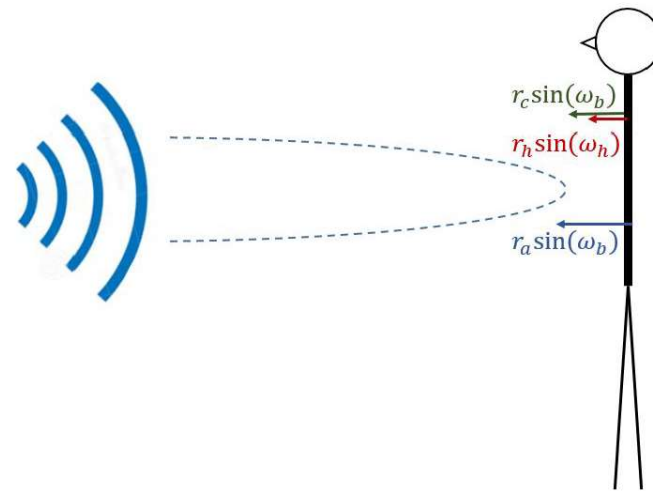
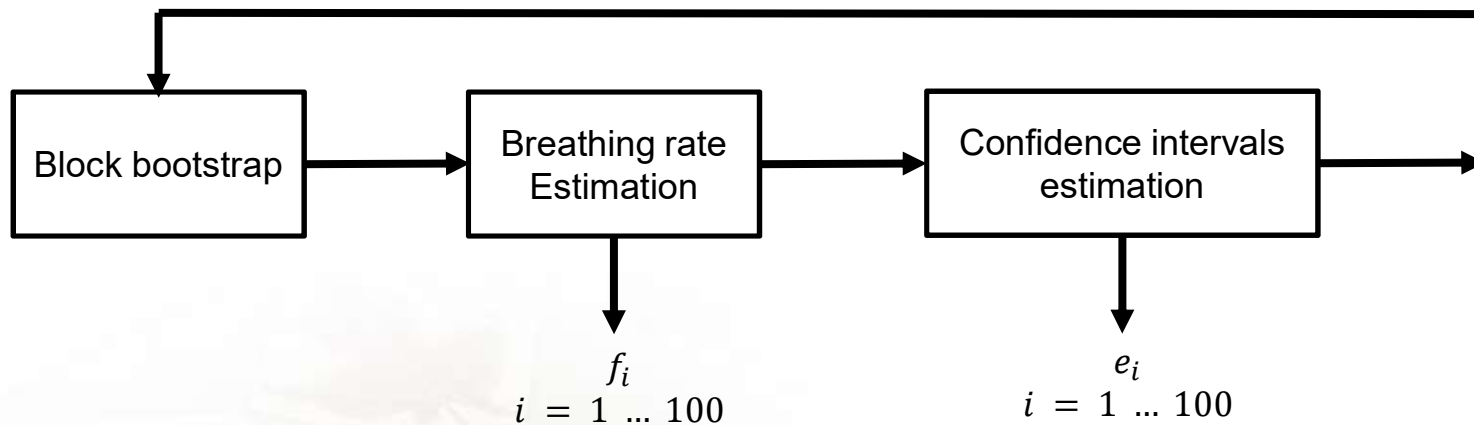

Fig. 1: The scenario where a subject is placed in front of the radar. Chest, abdomen and heart move periodically.

Confidence interval for estimating breathing rate from the radar signal, cont.



$$f_{est} = \mu_{est} = \text{mean}(f_i)$$

$$\sigma_{est} = \text{std}(f_i)$$

$$95\% \text{ confidence interval} = [\mu_{est} - 1.96\sigma_{est}, \mu_{est} + 1.96\sigma_{est}]$$



Confidence interval for estimating breathing rate from the radar signal, cont.



- We are using bootstrapping method in order to find a confidence interval for each estimation method.
 - Every 3 seconds the last 30 seconds are considered.
 - 100 random 15 seconds are chosen and one estimation is given for each segment.
 - Mean and variance of estimations is calculated
 - Mean of estimation error is calculated

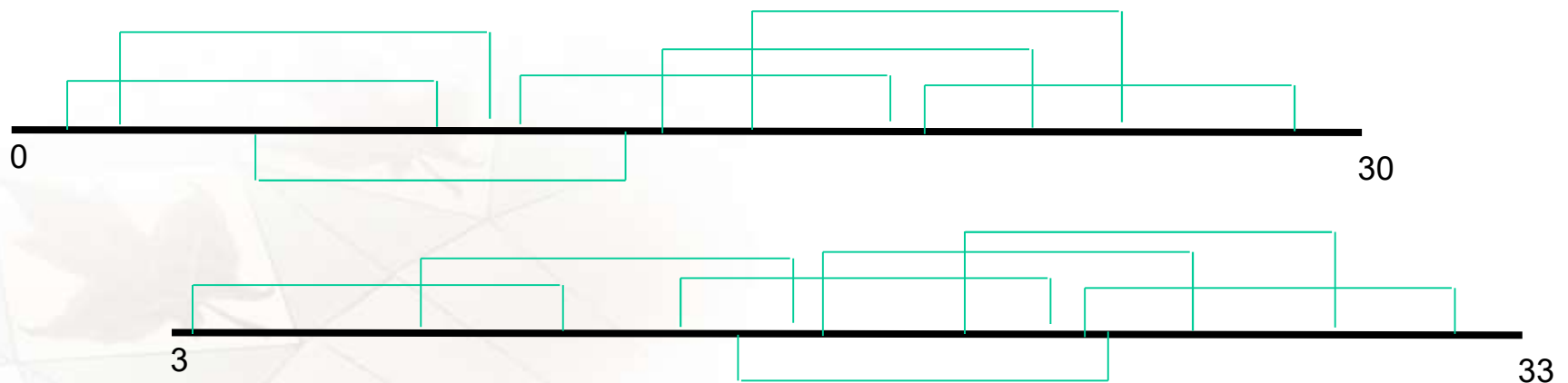

Experimental data: Stationary subject sitting in front of the radar

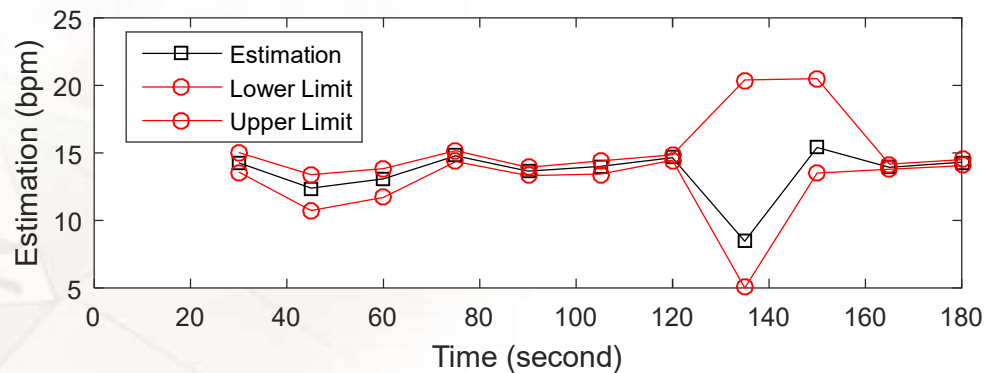
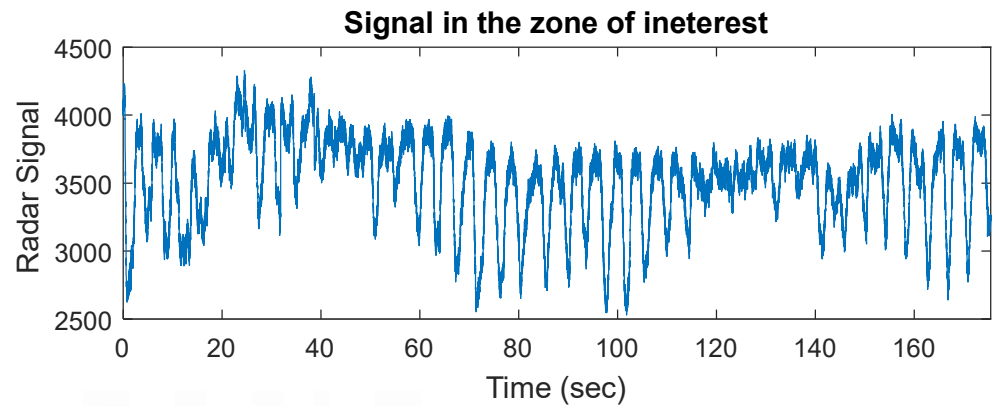

Challenges



- Identifying a person
- Challenges with breathing estimation
 - Both chest and abdomen move due to breathing
 - Nonlinear nature of radar signal generates harmonics of vital signs alongside with their multiple inter-modulations.
 - Posture and position affect the strength and other characteristics of received signal
 - Detect stop-breathing events



Cameras



- Cameras are ubiquitous and inexpensive
- Camera can detect:
 - Posture
 - Activity
 - Detect and identify multiple people
 - Displacement of the chest - Breathing rate
 - Heart rate – Blood Volume Pulse



Video processing steps [4]

- Presence
- Identification
- Posture detection
- Activity detection
- Breathing and heartbeat estimation

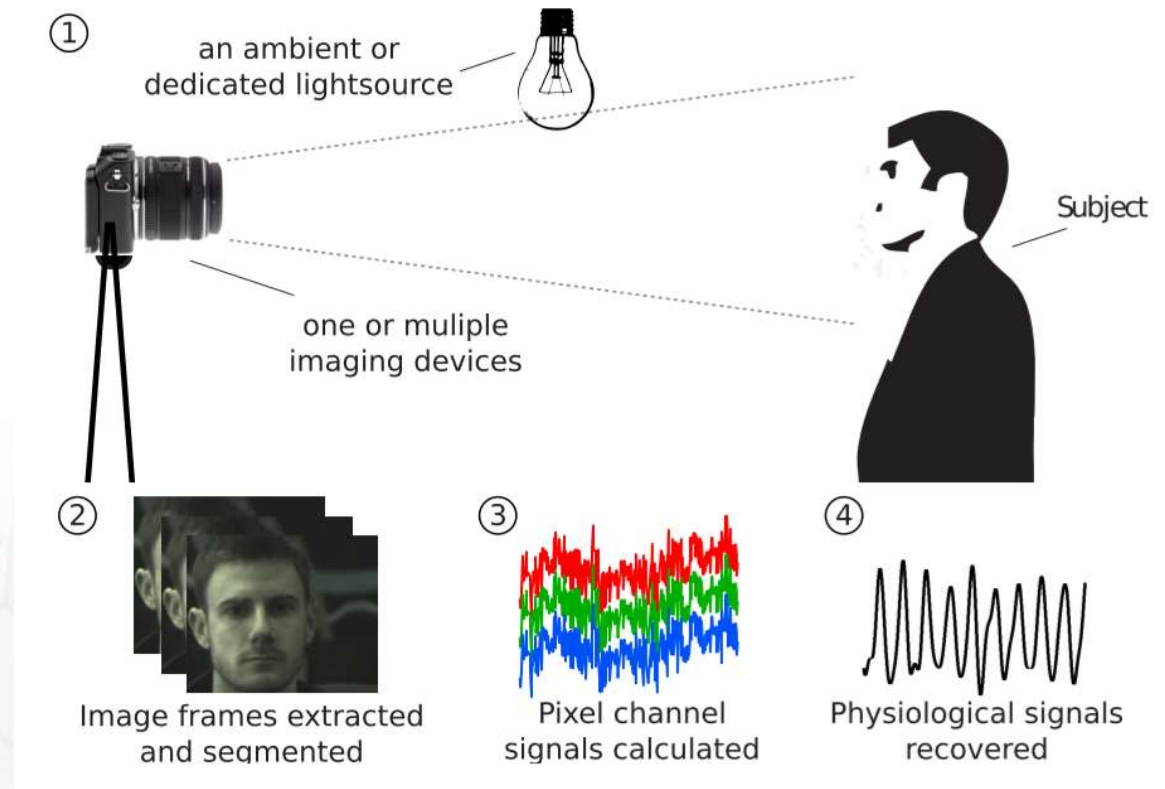

Video signal - PPGi



- Photo-plethysmography imaging (PPGi) is noninvasive way of sensing the cardiovascular blood volume pulse through variations in transmitted or reflected light
- Skin change its optical properties with perfusion

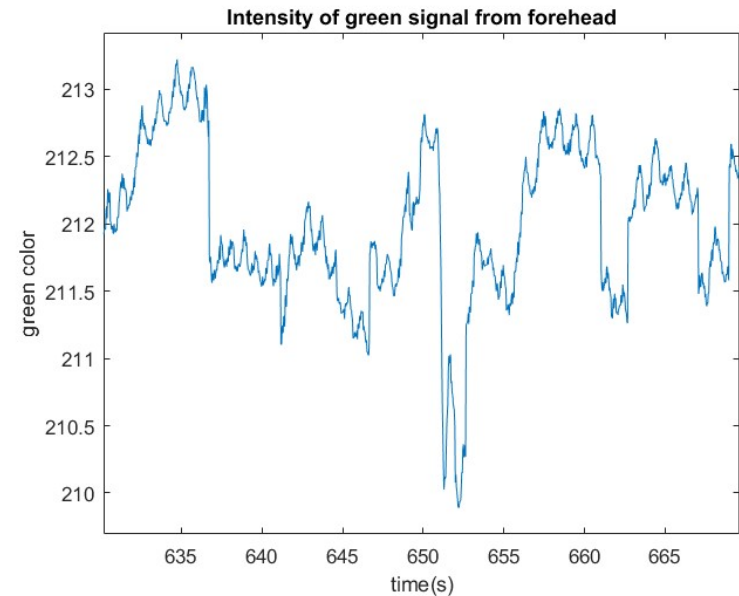

Video signal - surface displacement measurement

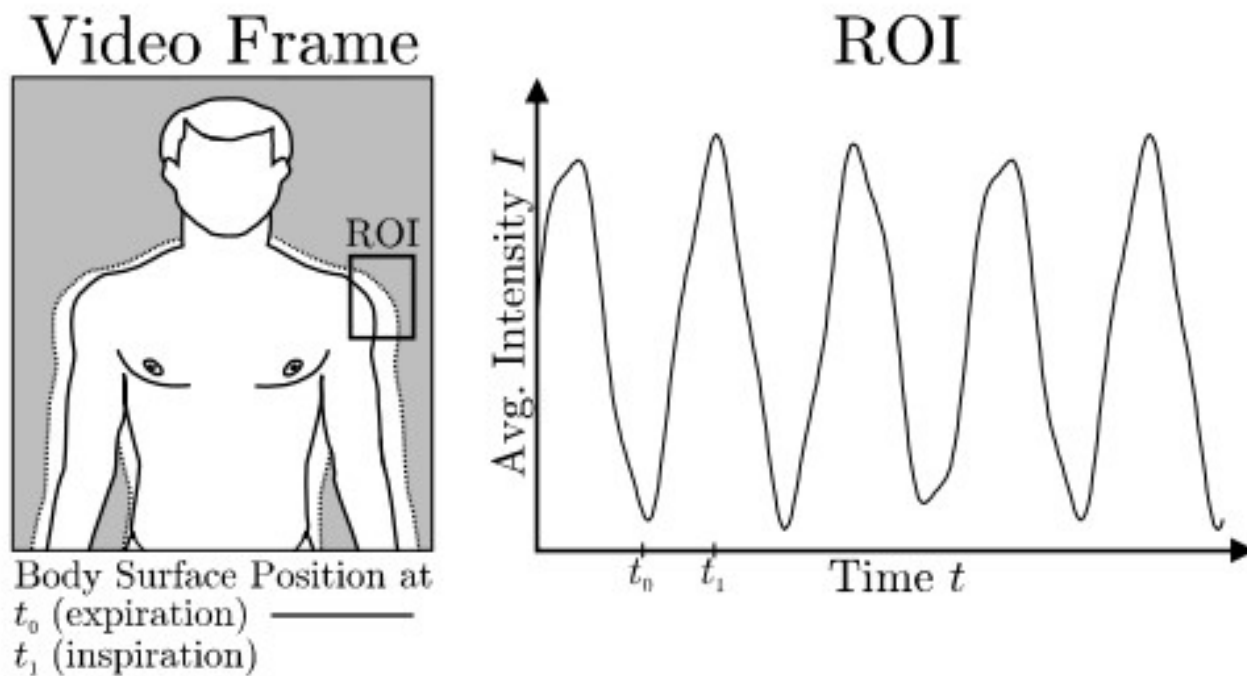

Figure is from the Reference [2]: C. Bruser et al. "Ambient and Unobtrusive Cardiorespiratory Monitoring Techniques," 2015.

Challenges



- Motion tolerance
- Ambient light and environmental variations
- Region of interest optimization
- Image enhancement and visualization
 - Eulerian Video Magnification



Fall detection



- Learning and recognizing a human shape and detecting a feature of the moving person.
- Fall-down comprises at least one of:
 - temporal sequence indicates a transition from an upright to a lying pose;
 - motion characteristics indicates a downward motion within a predetermined time period; and
 - there is an abrupt change in the trajectory for the object of interest.



3D camera applications



3D camera measures depth based on illuminating the scene with a controlled light source and measuring the backscattered light.

- Video games
- Game-based rehabilitation exercises
- Robotics
- Compensating for patient movement during medical imaging
- Fall detection
- Sign language recognition



Outline



- Introduction
- Traditional approaches
- What signals can be observed remotely
- Sensors
 - Radar
 - Camera
- Recent works and future directions



Using mobile phone as a sonar to detect breathing rate [6]



- Systems and methods of identifying motion of a subject, WO 2016093927 A3, University Of Washington, 2015
- Uses smartphone's speaker as an active sonar transmitting sound waves at 18-20 kHz
- Chest and abdomen motions create changes in the reflected sound wave
- Reflected sound wave is detected using smartphone's microphone
- Application: sleep apnea
- Experiment: 87 patients and 57 healthy subjects
- 98% accuracy in detecting obstructive sleep apnea
- Very high accuracy in classifying levels of sleep apnea

Wireless infrastructure for detecting vital signs: WiBrethe [8]



- The human body acts as a reflector of the wireless signal.
- The minute chest and abdomen movements amplitude-modulate the wireless signal before it reaches the receiver.
- Respiratory rate is extracted from the periodicity of the amplitude modulation.
- Error: 2.16 breaths per minute

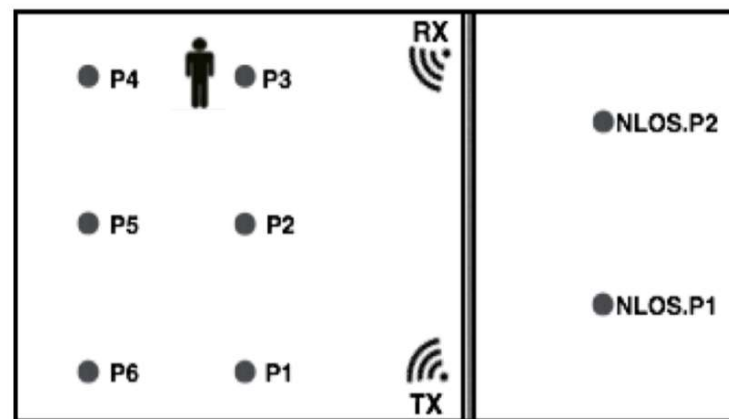

Future Directions in the Field



- Problems
 - People detection in uncontrolled environment
 - Multiple people identification and tracking
 - Supervised algorithms trained only for a number of specific cases
- Potential directions
 - Improvements of the sensors or new sensors
 - Sensor fusion at the massive scale
 - Inferring actions and conditions using unsupervised learning techniques
 - Inferring complex actions

Acknowledgements



- Thanks to my M.Sc. and Ph.D. students
- Thanks to Canadian funding agencies (NSERC, OCE, MITACS, IRAP) and to industrial partners for support
- Thank you for your attention

References



1. T. Teixeira, G. Dublon, A. Svvides, "A survey of human-sensing methods for detecting presence, count, location, track and identity," ENALAB Technical Report 09-2010, Vol. 1, No. 1, September 2010.
2. C. Bruser, C. H. Antink, T. Wartzek, M. Walter, and S. Leonhardt, "Ambient and Unobtrusive Cardiorespiratory Monitoring Techniques," IEEE Reviews in Biomedical Eng, Vol. 8, pp: 30-43, 2015.
3. A.D. Droitcour, *Non-contact measurement of heart and respiration rates with a single-chip microwave Doppler radar*. Diss. Stanford University, 2006.
4. D. J. McDuff, J. R. Estep, A. M. Piasecki and E. B. Blackford, "A Survey of contactless Optical Photoplethysmographic Imaging Methods," Conf Proc IEEE Eng Med Biol Soc. 2015.
5. M.Z. Poh, D.J. McDuff, R.W. Picard, "Advancements in Noncontact, Multiparameter Physiological Measurements Using a Webcam," IEEE Transaction on Biomedical Eng., Vol. 58, No. 1, Jan. 2011.
6. R. Nandakumar, S. Gollakota, N. Watson, "Contactless Sleep Apnea Detection on Smartphones," The 13th Annual International Conference on Mobile Systems, Applications and Services (MobiSys'15).
7. M. Zhao, F. Adib, D. Katabi, "Emotion Recognition using Wireless Signals," International Conference on Mobile Computing and Networking (Mobicom'16)
8. R. Ravichandran, E.t Saba, K.Y Chen, M. Goel, S. Gupta, S N. Patel, "WiBreathe: Estimating Respiration Rate Using Wireless Signals in Natural Settings in the Home," IEEE International Conference on Pervasive Computing and Communications (PerCom), 2015.

