

Achieving scalable services in 5G

Padma Pillay-Esnault
Distinguished Engineer Future Network
padma@huawei.com

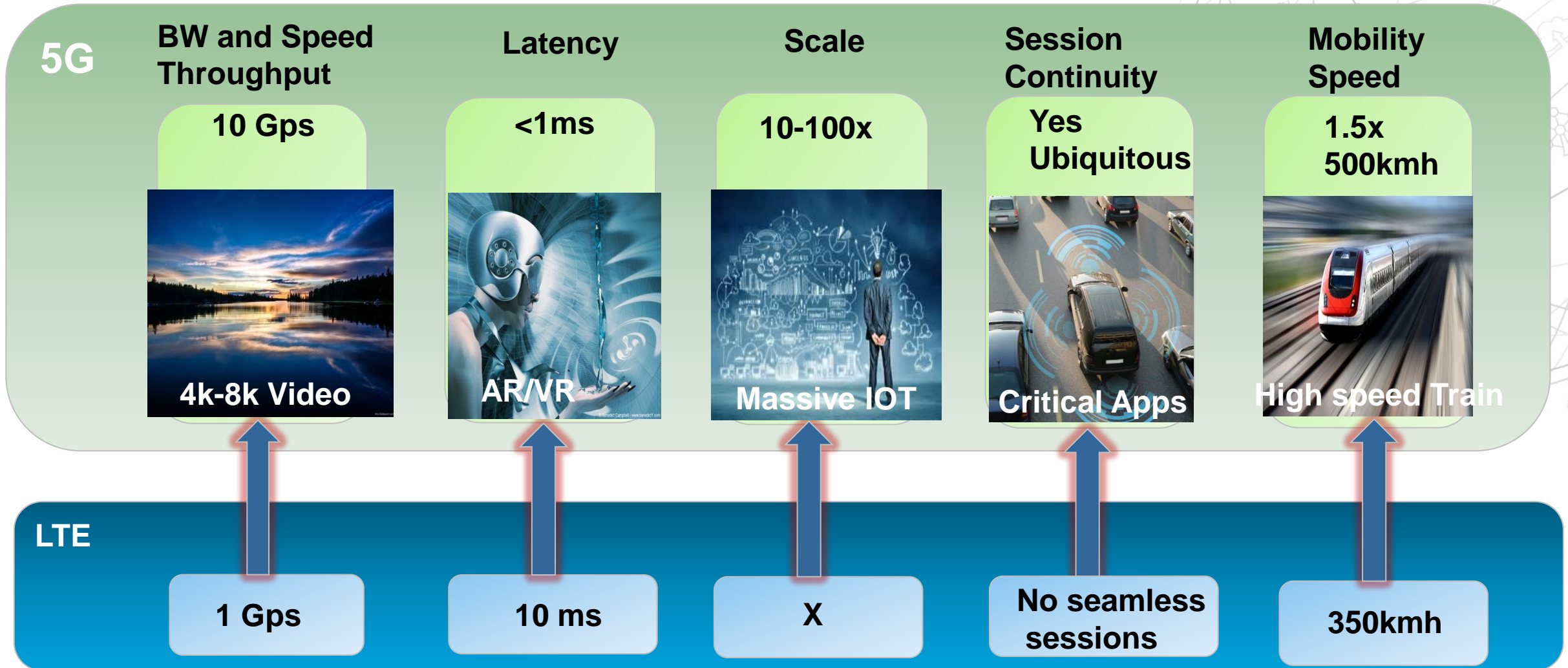

5G Redefining Mobility experience in Future Networks



■ Various Sources for Data: Huawei – 5G: A technology Vision & 3GPP

Tomorrow's needs and today's network ...

The adoption of 5G with its new requirements are going to challenge the infrastructure.

- **Scale**
- **Mobility (large range and fast)**
- **High throughput and low latency**
- **Security**
- **Self- Aware/Managing Network**

- **Energy preservation and low power consumption for devices**
- **Deployment over a heterogeneous Access**
- **Session continuity**

- **The Internet was originally designed as a static network.**
- **The EPC/RAN interconnects with the core IP network - hybrid of 2 Architectures**
- **Good enough for 5G and beyond?**
 - **Scale with more density?**
 - **Bigger “pipes” & Faster CPU vs Green**
 - **Context Awareness?**
 - **Identity Awareness?**
 - **Session continuity?**

IP Addresses

The IP address semantic is overloaded

Name/Identifier of the node

Physical Address of the node/Locator of the node

As the ID is tied to the node "Bob" at the office ID will be different from "Bob" at home

TCP can only work with no break if we retain the IP address which implies sub optimal routing in mobility

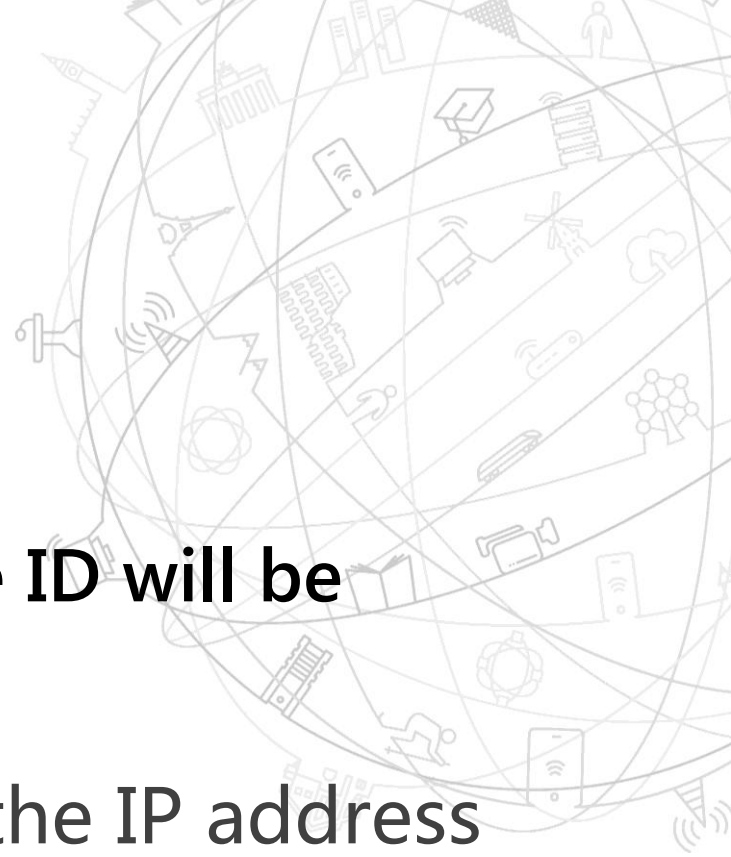

ID Oriented Networks in a nutshell

Basics

- Principle : Need to dissociate the name and location and make them independent.
- ID can be the name of a node, an app or anything
- The Identifier movement is transparent to the higher layers.
- The forwarding is achieved by binding the ID with an ip address or locator.

➤ One user can have multiple IDs or

Properties

- Native mobility
- Apps can be based on ID
- Addresses multi-homing ID have global significance(scope),
- Context awareness based on ID profile
- Security also can be ID based
- Fast deployment – Reuses already deployed and working (if IP)

ID-Oriented Networking (ION)

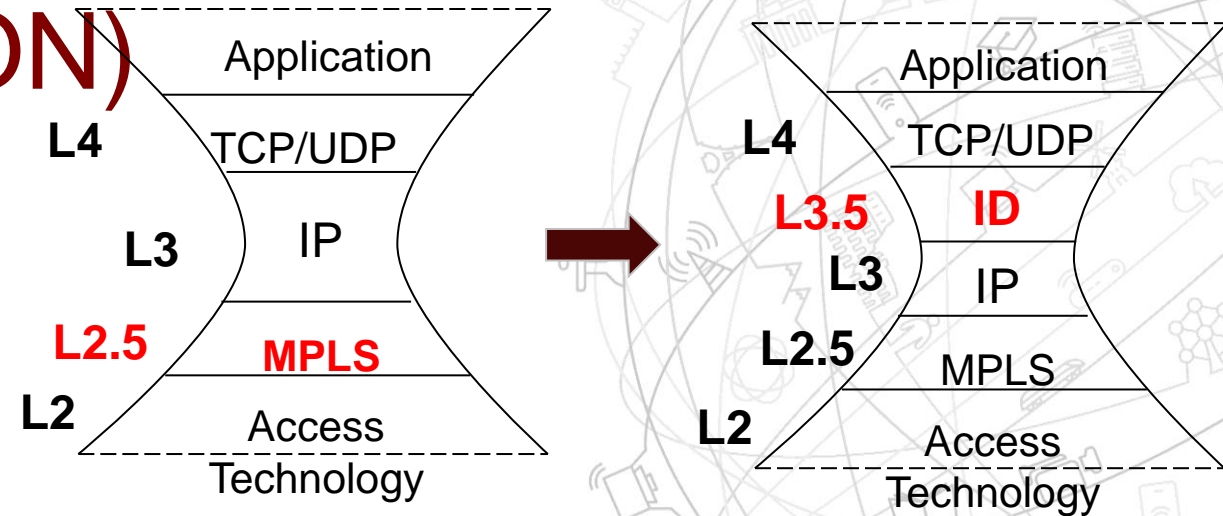
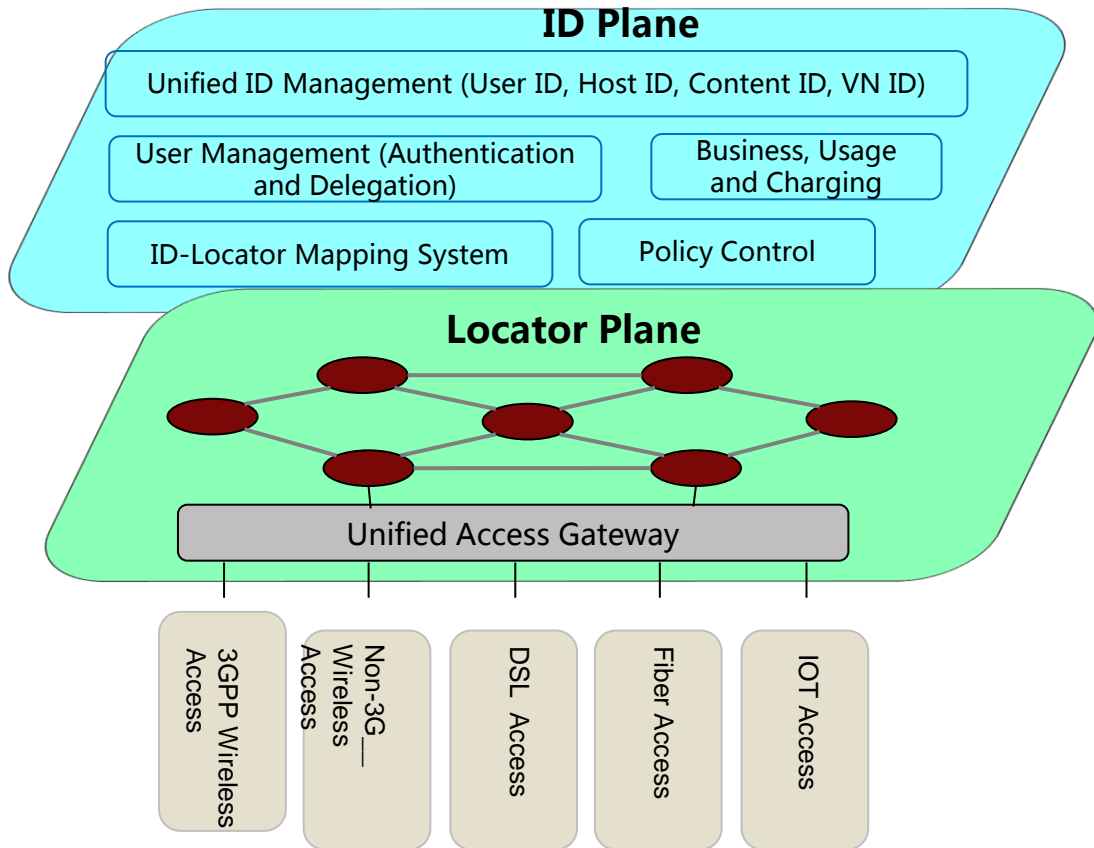

- No need for clean slate
- Reduced Capex and Opex
- **Global Reachability Possible: Everything, allocated with a unique ID,**
- **Innovation Speedup : Locator plane as a transport layer, while ID plane as a service and business layer. New services and business can be developed on top of ID without changing the underlying locator plane.**
- **Map and Encapsulate packets which can run on an IP core**

Change of IP address in mobility

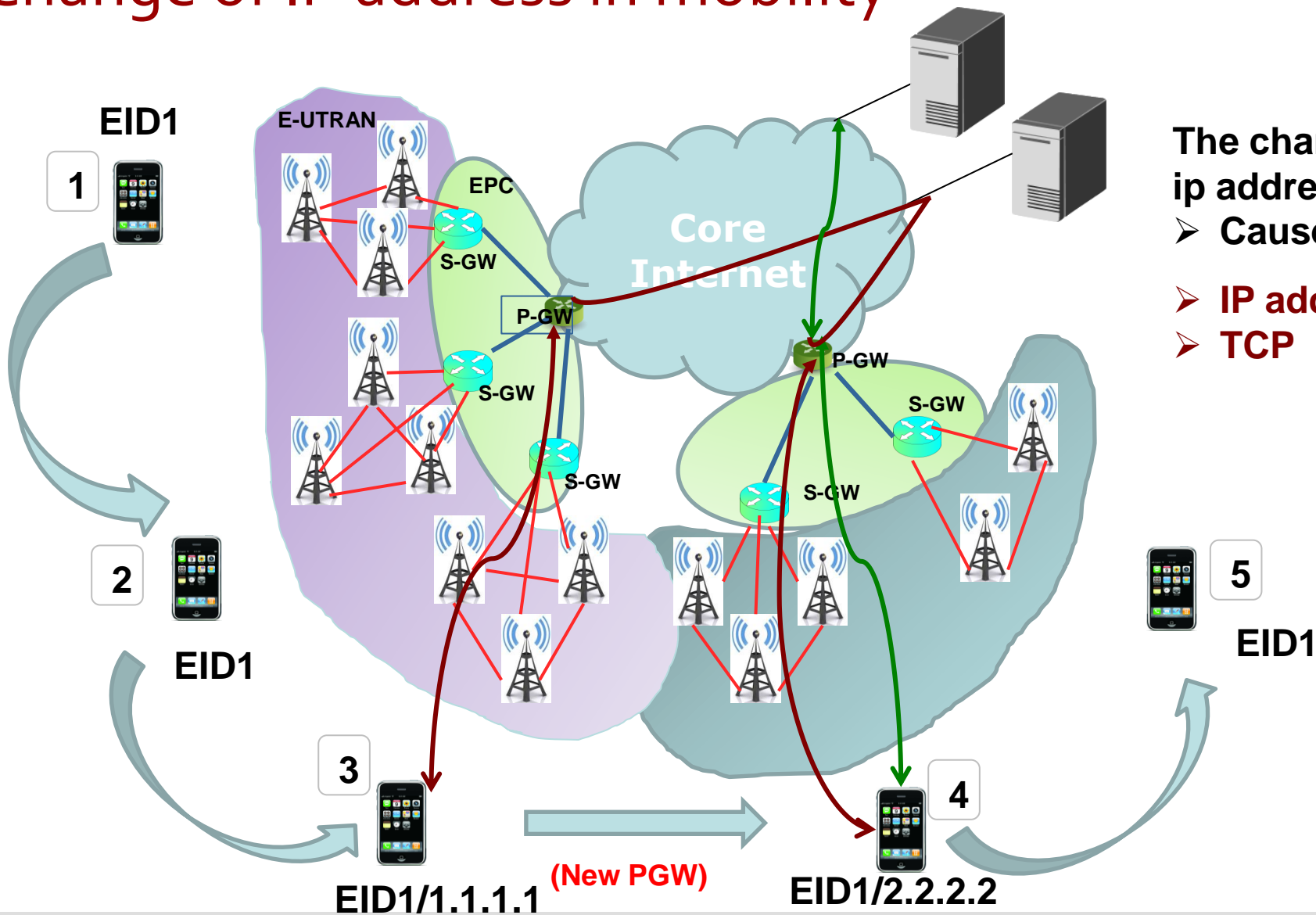

The change of P-GW and change of ip address pool will

- Cause change in IP address in UE
- IP address change is transparent to apps
- TCP ID based session continuity possible

Thank you

www.huawei.com

Copyright©2015 Huawei Technologies Co., Ltd. All Rights Reserved.

The information in this document may contain predictive statements including, without limitation, statements regarding the future financial and operating results, future product portfolio, new technology, etc. There are a number of factors that could cause actual results and developments to differ materially from those expressed or implied in the predictive statements. Therefore, such information is provided for reference purpose only and constitutes neither an offer nor an acceptance. Huawei may change the information at any time without notice.

Overview of standardized mobility solutions

SDO	Solution	Methodology	Advantages	Limitations	Market Proven
IETF	Mobile IPv4	Home Agents, Home Address, Care-of addresses	Use of IPv4, retain same ip address	Handover latency, signaling overheads in transition, suboptimal triangular routing, Limited QOS	
IETF	MIP V6	Address Autoconfig, autodiscovery of neighbors, Care-of-Addresses use of ipv6 hdr options for destination options	Always On Use of IPv6 Session persistence	Handoff latency, Limited awareness of heterogeneity, requires kernel changes, Security issues -	
3GPP	3G/GTP	Tunnels through eNB, S-GW and P-GW	Fast handoff	Tunnel re-creation on move, no session continuity.	Yes
3GPP	4G/LTE/GTP	Tunnels through eNB, S-GW and P-GW	Fast handoff	Tunnel re-creation on move. Service continuity is limited within a P-GW	Yes
IETF	Proxy Mobile IPv6 (PMIPv6)	Mobile Access Gateway (MAG) and Location Mobility Anchor (LMA)	Fast handoff retain same ip address	Session continuity limited to local administrative domain, centralized LMA may not scale well.	Yes
IETF	Distributed Mobility Management (DMM)	Mobility anchors, partial session distribution	Fast handoff	Triangular routing only for on-going sessions same as Mobile IP. Optimized for new sessions only. No RFC yet	
IETF	LISP	ID separation from location. Both ID and locator are IP address based	Use of ID over IP	Under Research	Experimental, ongoing trials through beta-network, waiting for multi-vendor market adoption.



TÜBİTAK

BİLGEM

INFORMATICS AND
INFORMATION SECURITY
RESEARCH CENTER

Hardware role in Mobile Scalability

Atakan Simsek

29.06.2016

UNCLASSIFIED

- I am not an expert in this domain but i want to draw attention about an idea.
- FPGA usage can increase scalability?
- Lots of study for CPU vs FPGA
- Moreover, GPU usage is added to this comparison
- Programming Language conversion to FPGA codes?
- This idea should be investigated.

FPGAs vs. CPUs: Trends in Peak Floating Point Performance

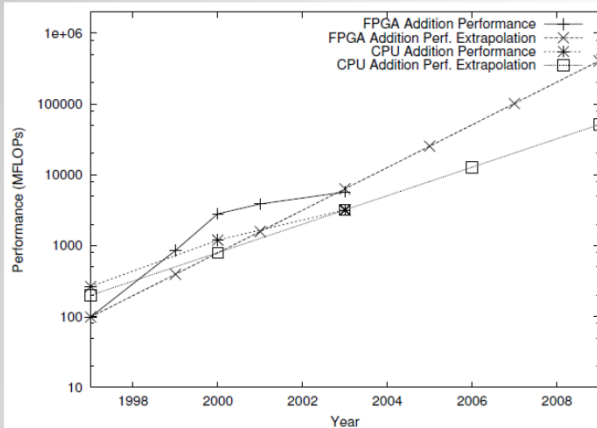

(a)

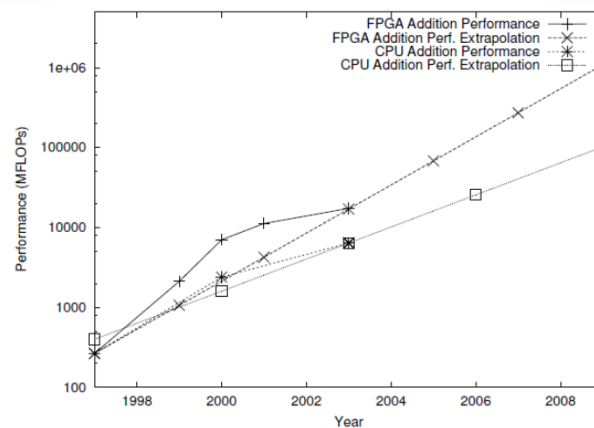

(b)

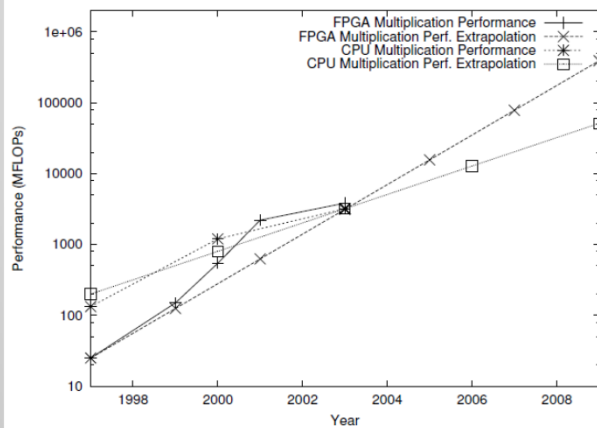

(c)

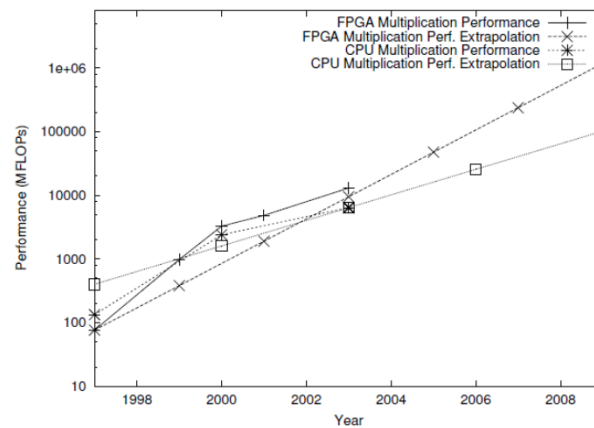

(d)

Floating-point addition:

(a) double precision

(b) single precision.

Floating point multiplication:

(c) double precision

(d) single precision.

[*] Underwood, Keith. "FPGAs vs. CPUs: trends in peak floating-point performance." *Proceedings of the 2004 ACM/SIGDA 12th international symposium on Field programmable gate arrays*. ACM, 2004.

FPGA-GPU-CPU Heterogenous Architecture for Real-time Cardiac Physiological Optical Mapping

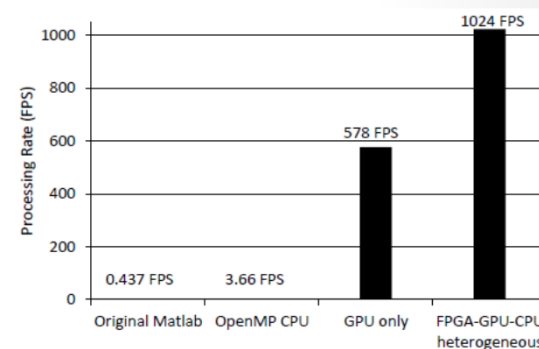
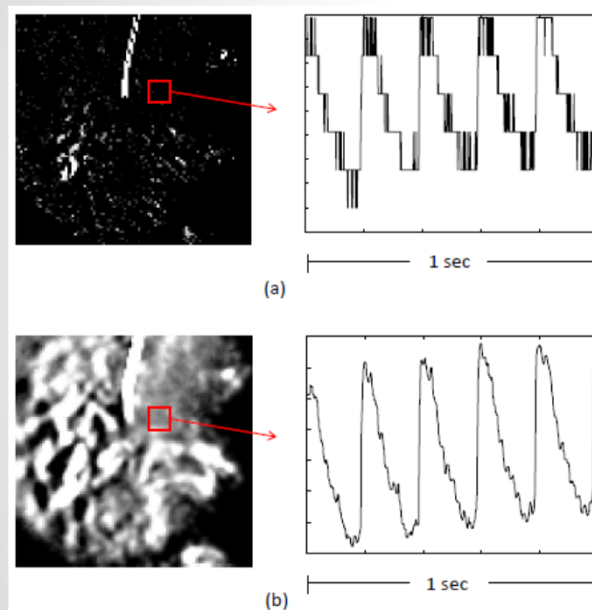

Fig. 4. The performance of the FPGA-GPU-CPU heterogenous implementation in comparison to the original Matlab, the OpenMP C++, and the GPU only implementation.

[*] Meng, Pingfan, Matthew Jacobsen, and Ryan Kastner. "FPGA-GPU-CPU heterogenous architecture for real-time cardiac physiological optical mapping." Field-Programmable Technology (FPT), 2012 International Conference on. IEEE, 2012.

Optimized Generation of Data-path from C Codes for FPGAs



- *FPGAs, as computing devices, offer significant speedup over microprocessors**
- *Furthermore, their configurability offers an advantage over traditional ASICs**
- *However, they do not yet enjoy high-level language programmability, as microprocessors do**
- *This has become the main obstacle for their wider acceptance by application designers**
- *ROCCC is a compiler designed to generate circuits from C source code to execute on FPGAs, more specifically on CSoCs.**
- *It generates RTL level HDLs from frequently executing kernels in an application**
- *In this paper, we describe ROCCC's system overview and focus on its data path generation**

[*] Abstract sentences from: Guo, Zhi, et al. "Optimized generation of data-path from C codes for FPGAs." Proceedings of the conference on Design, Automation and Test in Europe-Volume 1. IEEE Computer Society, 2005.

HAsim Hybrid Modules

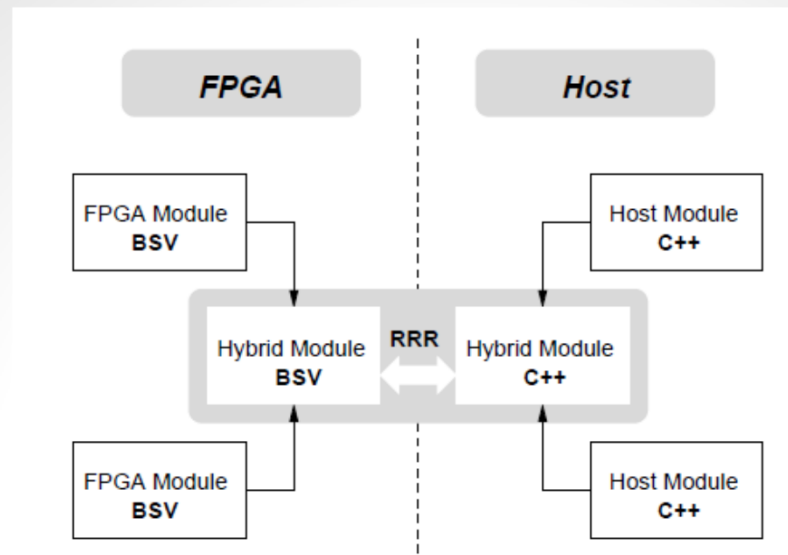

- *Remote Request/Response* (RRR) that model developers can use to communicate between the FPGA and CPU partitions of a hybrid performance model
- For hybrid HAsim models, they partition logic between the CPU and the FPGA at the granularity of a *module*. Models are created from a collection of pure-software (CPU), pure hardware (FPGA) and hybrid hardware/software modules

[*] Parashar, Angshuman, et al. "Hybrid cpu/fpga performance models." 3rd Workshop on Architectural Research Prototyping (WARP 2008). 2008.



TÜBİTAK

BİLGEM



salzburg**research**

Ferdinand von Tüllenbug

Dependable mobile Communication for Critical Infrastructures

Critical Infrastructure Communication



Electricity



Health



Transport



Finance

Dependable Communication is required
Outages lead to failures, degraded services

In future rising complexity:

- Interconnection / growing of distinct CI
- Massive inclusion of sensors, actuators, mobile devices
- To create new services / businesses
- Also over long distances (WAN)



- Need for
 - Standardization of communication
 - Flexibility and programmability
 - For agile service composition
 - Simpler maintainability / management



5G for Future CI Communication

High data rates

- 300Mbit/s downlink and 50 Mbit/s uplink per user

Low latency

- 1ms/10ms end-to-end
- Applications / data need to be hosted near end points

Support for many devices in small areas

- 400 user per km² in urban areas

Increased flexibility

- e. g. D2D, D2B, M2M

Standardization

- Many cheap devices

Energy efficiency

5G and Software-defined Networking (SDN)



SDN provides

- Separation of Control / Data plane
- Central view
- Standardized / Centralized Configuration
- Network Function Virtualization (NFV)
 - Avoid middleboxes (e.g. Firewalls, Balancers)
 - Reduces Long-time invests / Rollouts
 - Network Service Chaining



A key role for 5G Critical Infrastructure Networks

- Flexibility of network reconfiguration
- Validation/Verification Capabilities
- Traffic Separation / Differentiation

Current Research Topics



Apply SDN and 5G to critical infrastructure communication

Traffic Separation and Differentiation for CI

- Network Slicing powered by SDN/NFV
 - Slices: Use Case/Application specific allocation of
 - Network Capacity (QoS)
 - Coverage
 - Network Functions

Network Dependability for CI

- Fault forecasting
- Fault prevention
- Fault tolerance
- Fault removal

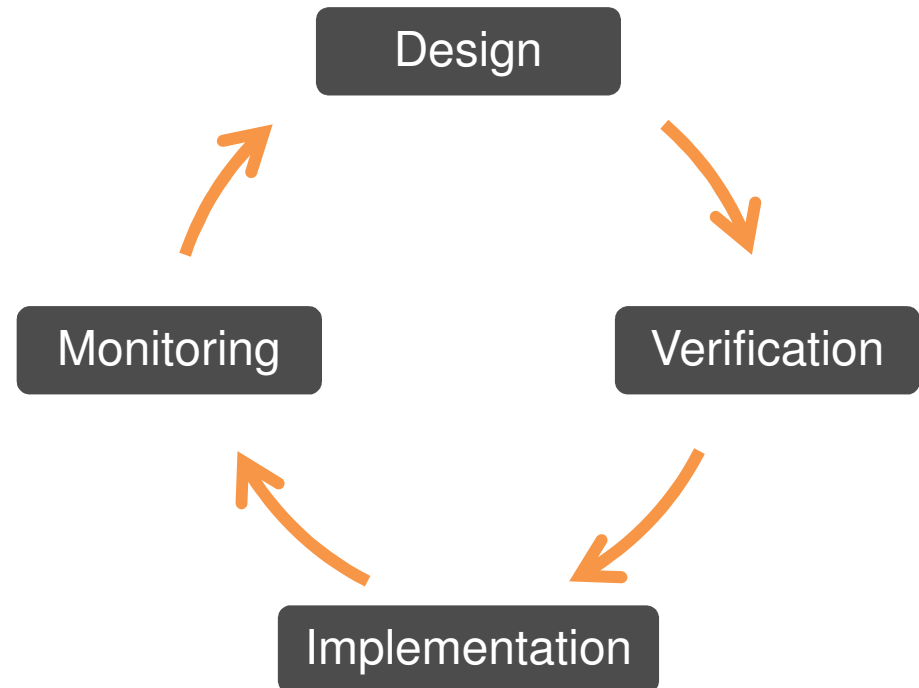



Further Salzburg Research Topics

- **Considering Mobility**
 - Radio Ressource Mgmt, Mobility management (Flow adjustment)

- **Develop Architectural Concepts**
 - Input to standardisation bodies



NOKIA

Network as a Service

Panel: Scalable Services in automated mobile network

- Wieslawa Wajda
- 29-06-2016

Translate into the need of a healthy balance of evolutionary & revolutionary concepts

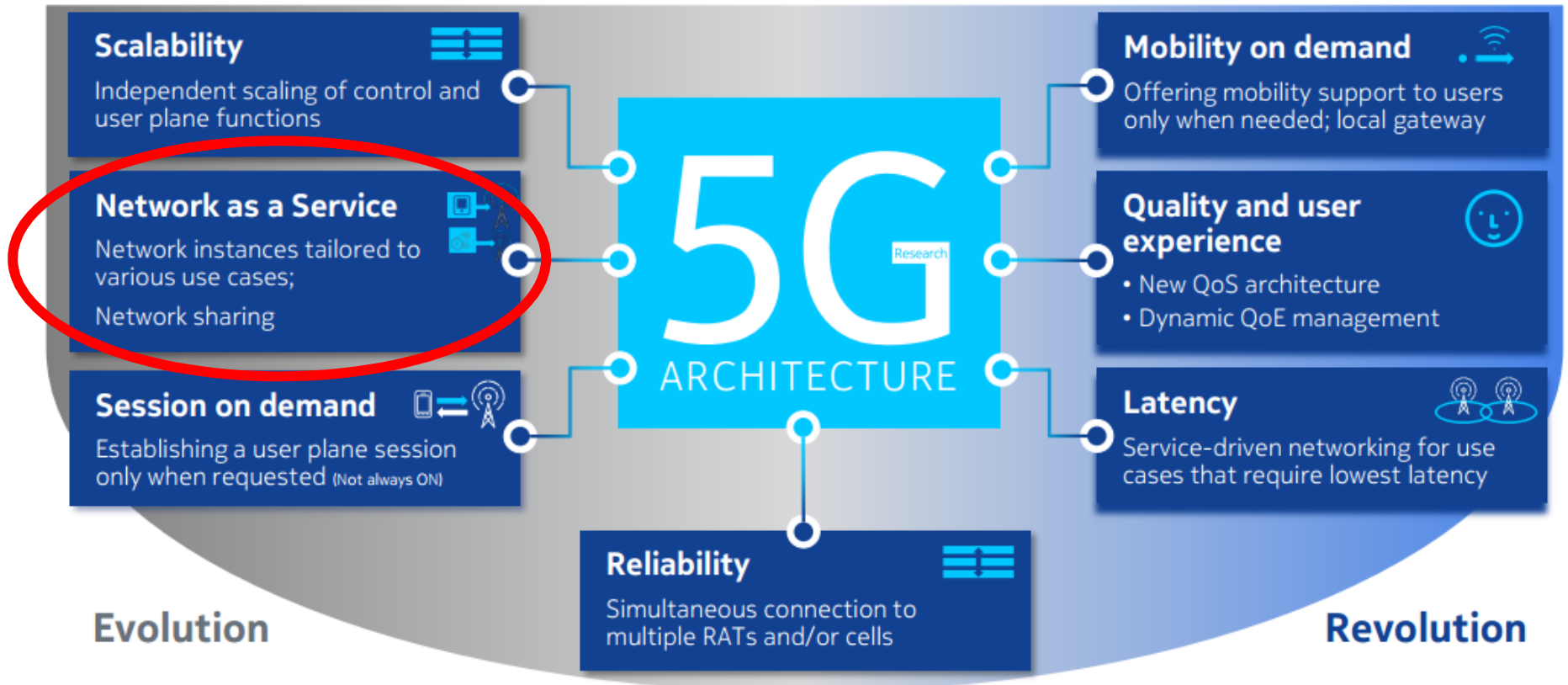

Source: Johannesberg Summit 2015, Peter Merz

NOKIA

Network as a Service

What is it?

Network as a service (NaaS) describes **services for network transport connectivity**.^[1]

NaaS involves the optimization of resource allocations by considering network and computing resources as a unified whole.

https://en.wikipedia.org/wiki/Network_as_a_service

Network-as-a-service (NaaS) **is a business model** for delivering network services virtually over the Internet on a pay-per-use or monthly subscription basis.

<http://searchsdn.techtarget.com/definition/Network-as-a-Service-NaaS>

Network as a Service (NaaS) **is sometimes listed as a separate Cloud provider** along with Infrastructure as a Service (IaaS), Platform as a Service (PaaS), and Software as a Service (SaaS). NaaS can include flexible and extended Virtual Private Network (VPN), bandwidth on demand, custom routing, multicast protocols, security firewall, intrusions detection and prevention, Wide Area Network (WAN), content monitoring and filtering, and antivirus.

http://www.service-architecture.com/articles/cloud-computing/network_as_a_service_naas.html

Multi-tenancy and sharing

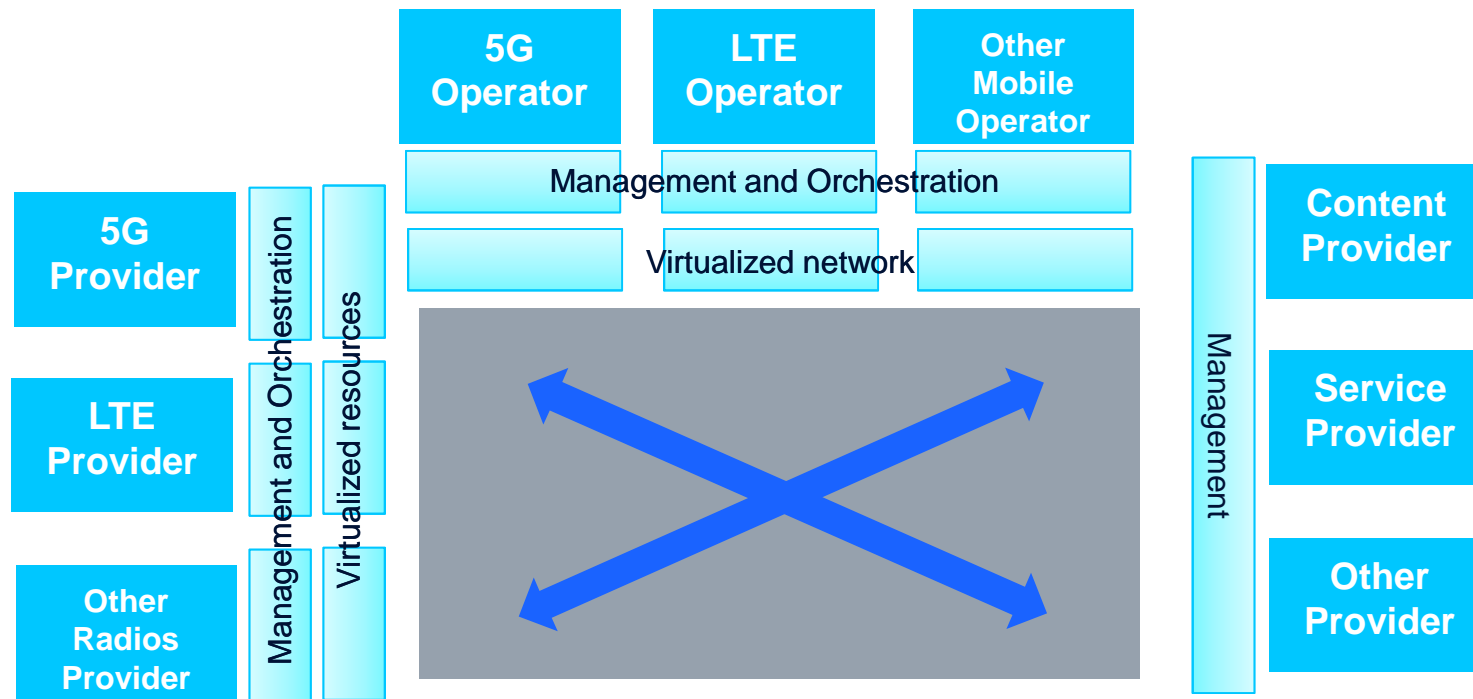

5G paradigm

service provisioning through controlled ownership of infrastructures



unified control framework through virtualization and programmability of multi-tenant networks and services

Questions

1. Is technology the decisive factor for 5G or is the 5G driven by business and economy?
2. Assuming success , what changes are anticipated by the various stakeholders w.r.t. business models, technology roadmap and market share?
3. Would this new ecosystem encourage the emergence of new providers?
4. Is the new ecosystem a challenge for the telecommunication players?
5. What is the expected social impact on users?
6. What is the role of standardization and regulation? That of a catalyst or a potential showstopper?

NOKIA