

Redox Sensors for the Control of Process and Waste Waters

Winfried Vonau, Frank Gerlach, Kristina Ahlborn, Sandra Sachse
Kurt-Schwabe-Institut für Mess- und Sensortechnik
Waldheim, Germany

Outline



- Introduction
- New approach for redox potential measurement
- Fabrication of redox electrode glass and glass paste
incl. characterisation
- Fabrication of the electrodes
- Electrode test (laboratory)
- Field operation (Control of Process and Waste Waters)
- Outlook
- Conclusion
- Acknowledgement

- Introduction
- New approach for redox potential measurement
- Fabrication of redox electrode glass and glass paste
incl. characterisation
- Fabrication of the electrodes
- Electrode test (laboratory)
- Field operation (Control of Process and Waste Waters)
- Outlook
- Conclusion
- Acknowledgement

Reduction potential (also known as **redox potential**, oxidation / reduction potential, ORP, pE, ε , or E_h) is a measure of the tendency of a chemical species to acquire electrons and thereby be reduced. Reduction potential is measured in volts (V), or millivolts (mV). Each species has its own intrinsic reduction potential; the more positive the potential, the greater the species' affinity for electrons and tendency to be reduced. ORP is a common measurement for water quality.

Trevor V. Suslow: Extension Research Specialist, Department of Vegetable Crops, University of California, Davis

$$\varepsilon = \varepsilon_0 + \frac{RT}{nF} \ln\left(\frac{a_{\text{Ox}}}{a_{\text{Red}}}\right) + \frac{m}{n} \ln a_{\text{H}^+}$$

ε ... single potential; ε_0 ... standard potential; a_{Ox} , a_{Red} ... ion activities;
 n ... number of electrons ; m ... number of protons

Potentiometry

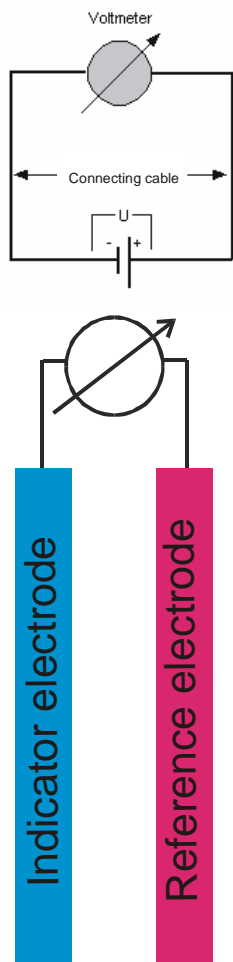

Determination of redox potentials



- Non-specific measurements
- Partial specific measurements
- Selective measurements

Measurements with oxidic electrodes



Measurements with Ion Selective Electrodes

Scheme of the measuring chain

measuring instrument

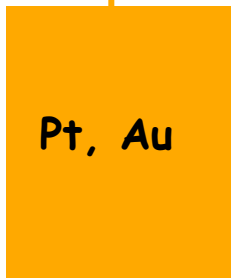

redox electrode



reference
electrode



Drawbacks

reducing solutions:
formation of hydrides

catalytic poisons, e.g. SO₂ or
other sulfur compounds,
contaminate their surface:
electrodes become unusable

presence of gaseous oxygen
and hydrogen:
influences the half cell potential

metals themselves can act as
catalysts in certain redox media

Pt, Au

under certain circumstances:
responds to chlorides and cyanides

Measuring errors of ± 25 mV
are considered normal.

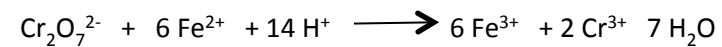
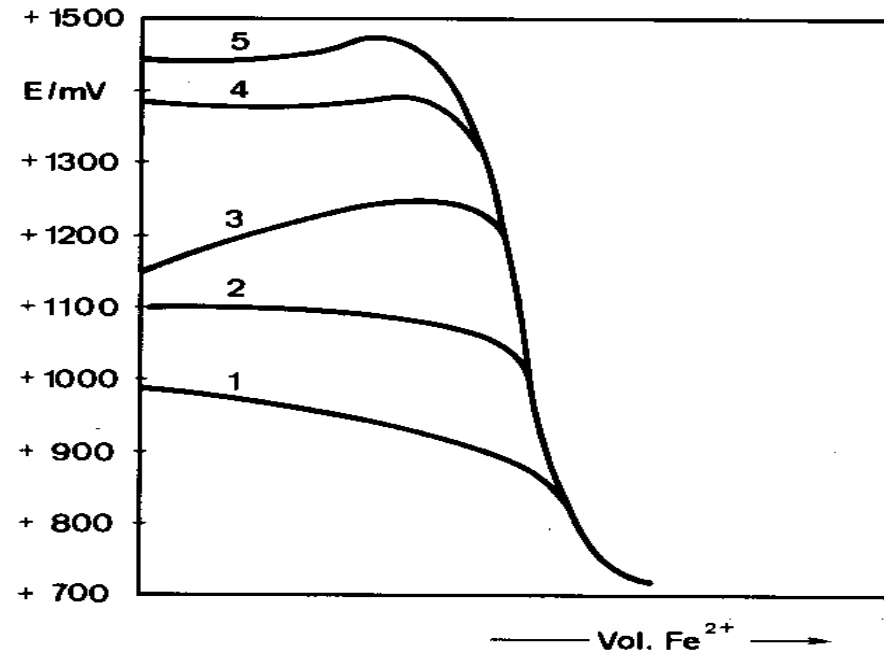
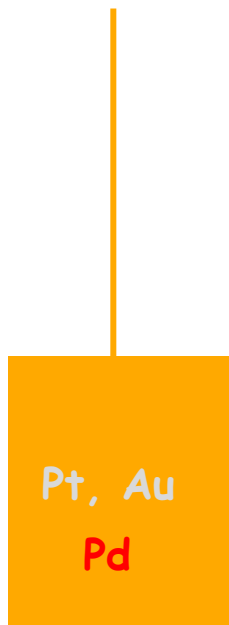

- 1 cathodically polarised (5 min)
- 2 untreated
- 3 annealed at 900 °C
- 4 anodically polarised (1 min)
- 5 anodically polarised (5 min)

Redox sensor

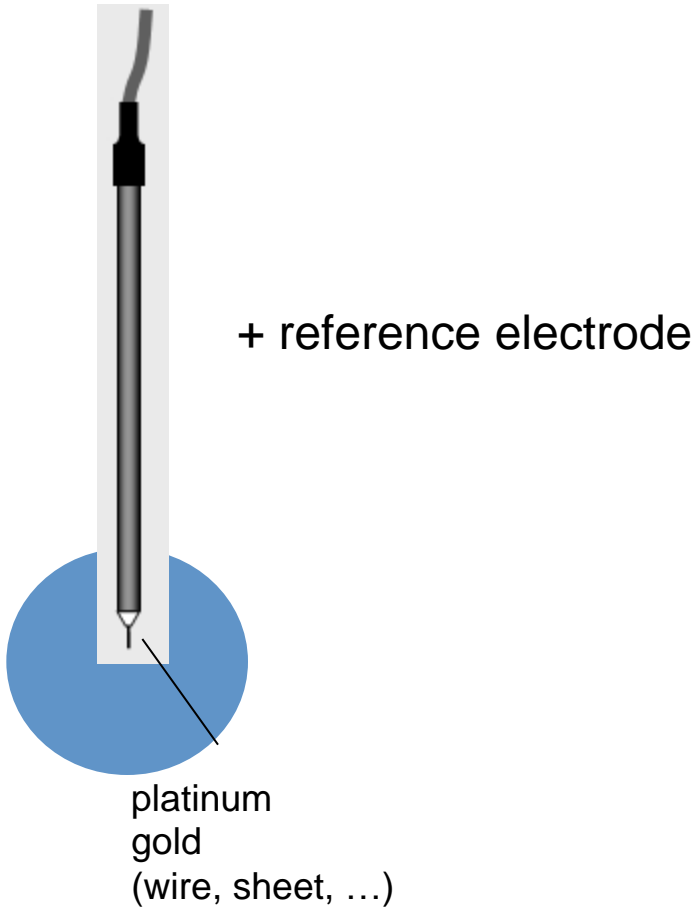

Only little volume of blood available
(capillary blood)

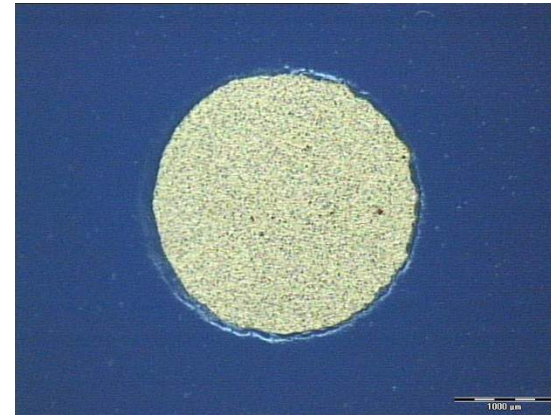

Redox electrodes in thick film
technology (Au, Pt, ...)

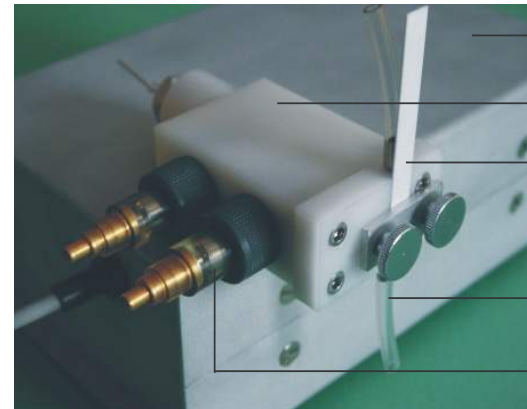
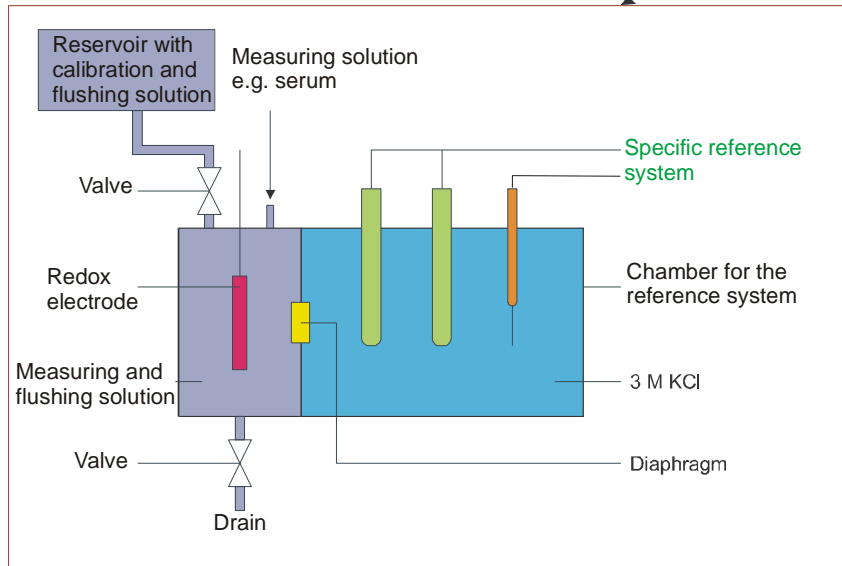
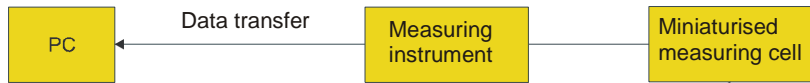

- Electronic module
- Redox module
- Redox electrode (thick film)
- Measuring and flushing solution
- Reference electrodes

System to condition, measure and calibrate redox measuring chains

Schematic assembly of the flow through measuring system to determine redox potentials in smallest quantities of biological liquids for fundamental investigations to estimate measurements with different electrode materials

Herrmann, S.; Berthold, F.; Vonau, W.; Mayer, M.; Bieger, W.: Elektrochemischer Redoxchip für bioanalytische Messungen. In: R. Poll, J. Füssel (Hg.): Dresdner Beiträge zur Medizintechnik, Band 1: 1. Dresdner Medizintechnik-Symposium – Innovation durch Einheit von Therapie und Monitoring. Dresden, TUDpress 2006, S. 55-60

Examples of electrode conditioning

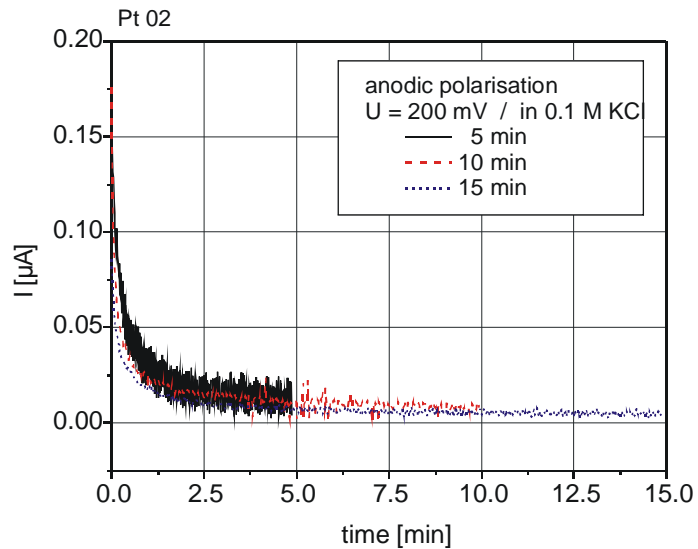

Flow of the current during anodic polarisation

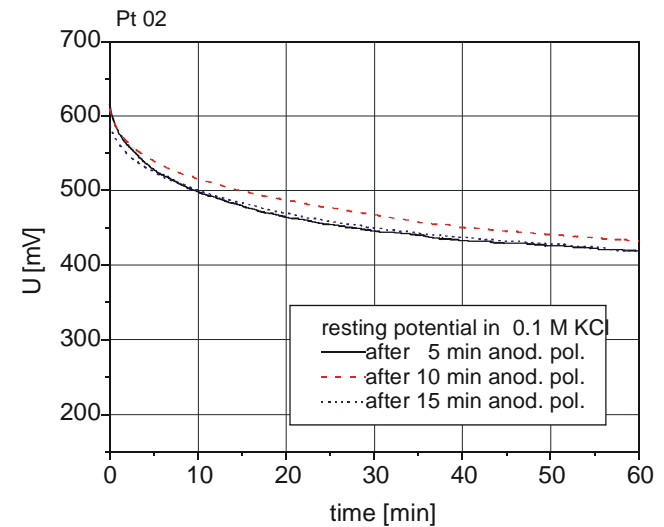

Potential run at platinum after conditioning by anodic polarisation

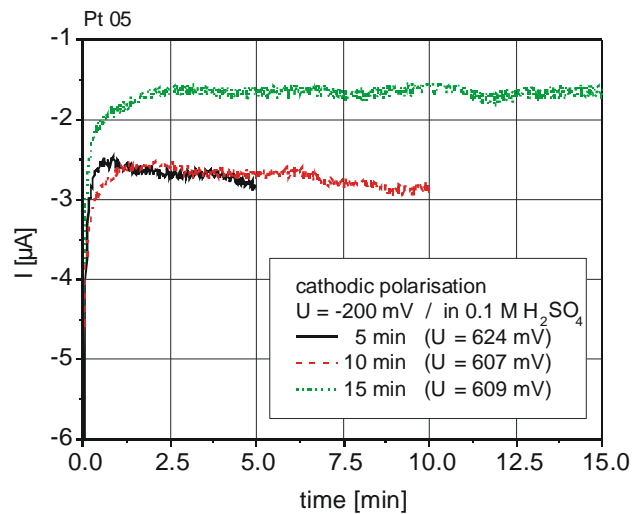

Cathodic polarisation, flow of the current

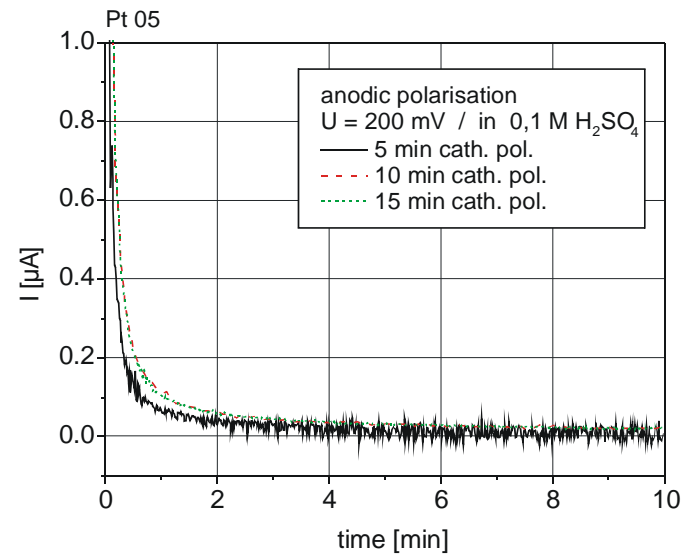

Anodic polarisation, flow of the current

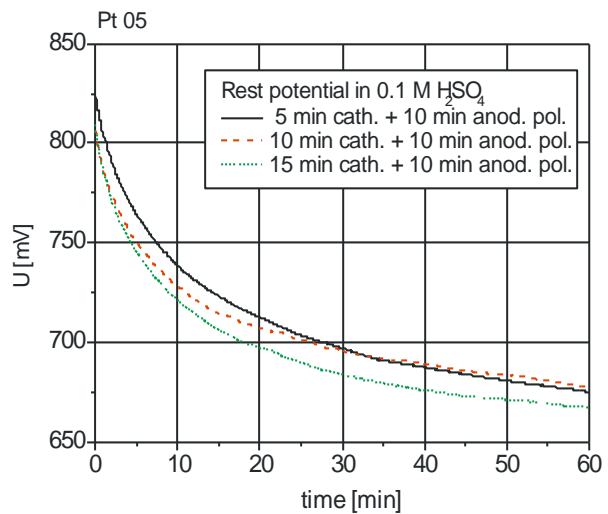

Potential curve of Pt after cathodic/anodic polarisation

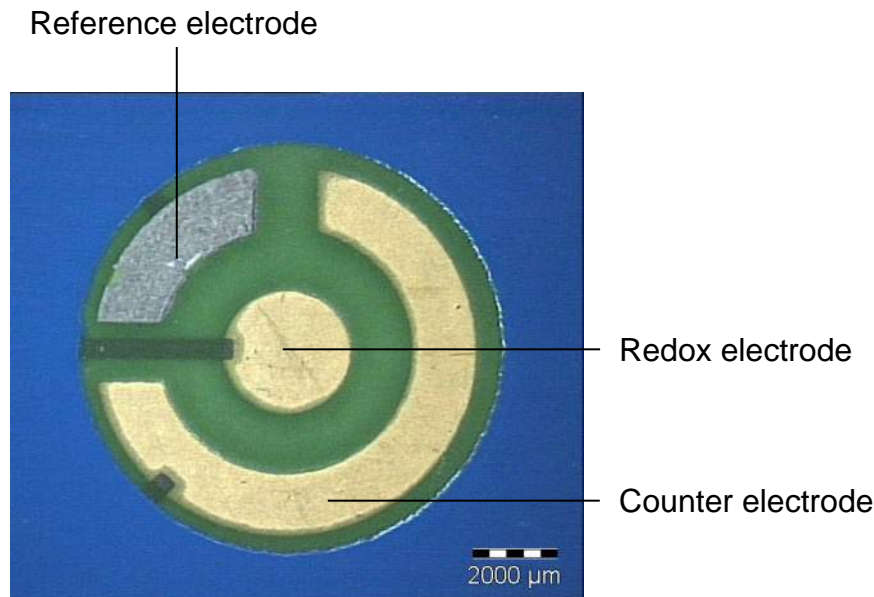

Sensor chip with 3-electrode-measuring system for the determination of the redox potential (fabricated in thick film technology)

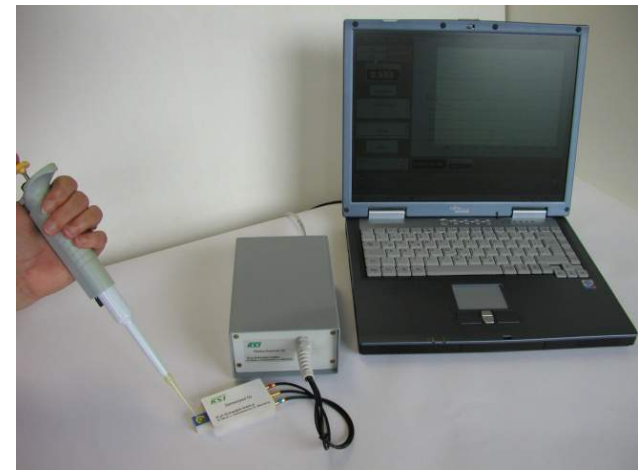

„Redox scanner 04“ and „Sensor pad 02“ with sensor chip as PC coupled device for quick determination of redox potentials in blood/serum



Sensor pad to contact and keep the redox chips

Vonau, W.; Herrmann, S.; Berthold, F.; Mayer, W.; Bieger, W.:
Chemie Ingenieur Technik 2007, 79. No. 9, 1385

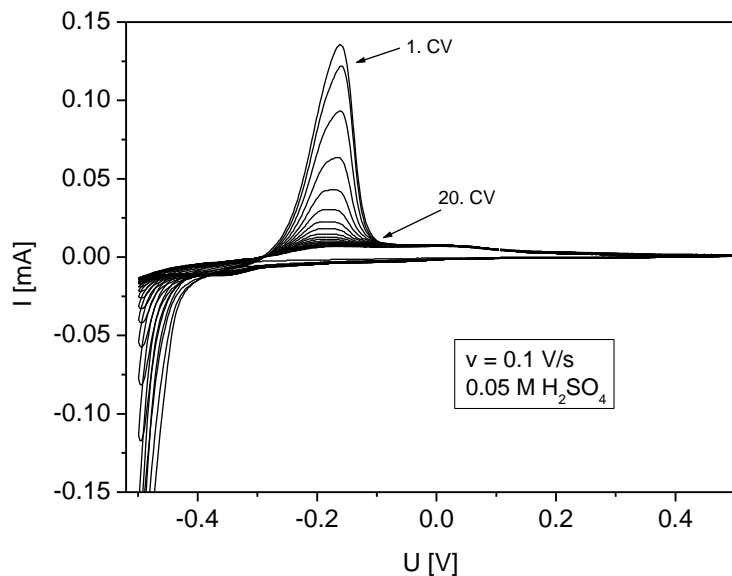

Conditioning of the surface of Au electrodes in thick film technology by cyclic polarisation (20 cycles)

Berthold, F.; Bieger, W.P.; Herrmann, S.; Vonau, W.:
DE 10 2004 054 521 (2004)

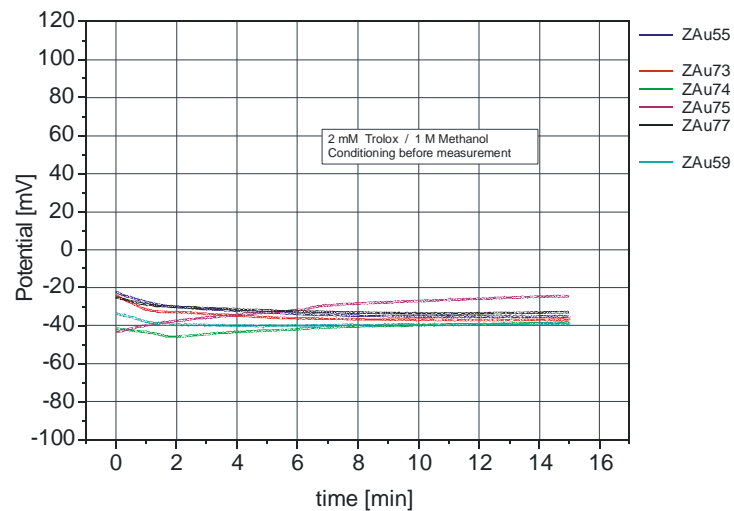

Redox measurement in Trolox reference solution

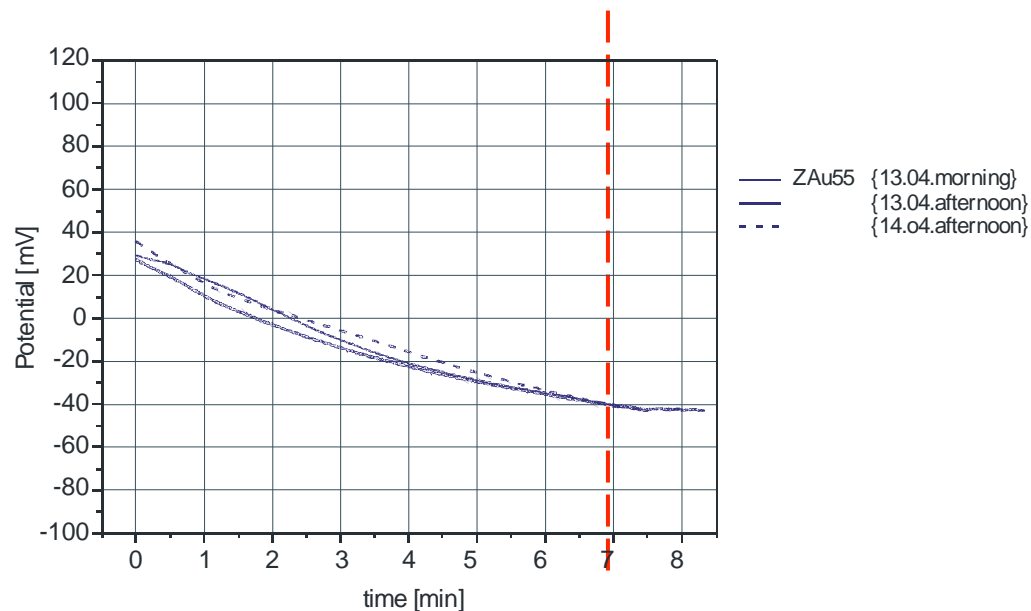

Redox measurement in serum (person Bk)

- Introduction
- **New approach for redox potential measurement**
- Fabrication of redox electrode glass and glass paste
incl. characterisation
- Fabrication of the electrodes
- Electrode test (laboratory)
- Field operation (Control of Process and Waste Waters)
- Outlook
- Conclusion
- Acknowledgement

Use of glass based (amorphous)
electrode membranes
instead of noble metals

oxidic glasses

siliceous glasses:

quartz glass

sodium lime glass (pH, pNa, pK)

semiconducting glass (redox potential)

mixtures of several basic glasses:

borosilicate glass

non-siliceous glasses:

borate glass

phosphate glass

non-oxidic glasses

saline glasses:

nitrate glass

fluoride glass

chalcogenide glasses

(mono and polyvalent ions)

metallic glasses

Polymer glasses:

PS

PMMA

GLASS-FORMING SYSTEMS

An **amorphous solid** is a solid in which there is no long-range order of the positions of the atoms.

electrodes with amorphous membranes
(e.g. pH-glass, chalcogenide glass or redox glass)

Ion conducting glasses

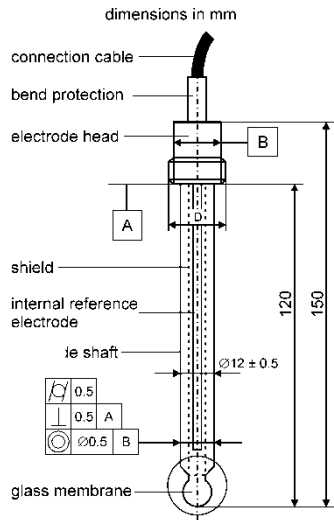

pH glass electrode according to GERMAN STANDARD DIN 19 263

Glass composition:
e.g. 72% SiO₂, 22% Na₂O; 6% CaO

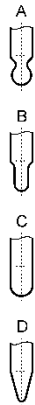
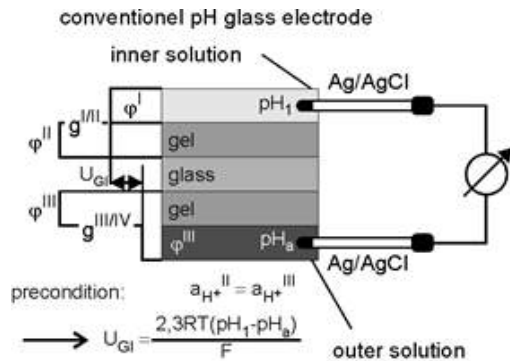

Drawbacks of chemical sensors with liquid components

- position dependence when stored and used
- pressure and temperature dependence
- mechanical instability
- limitations concerning the miniaturisability
- impractically applicable for measurements on surfaces
- costly because of many manual production steps



All solid state (glass based) electrode

pH-glass based electrodes



pH glass	ion conducting
metal	electron conducting

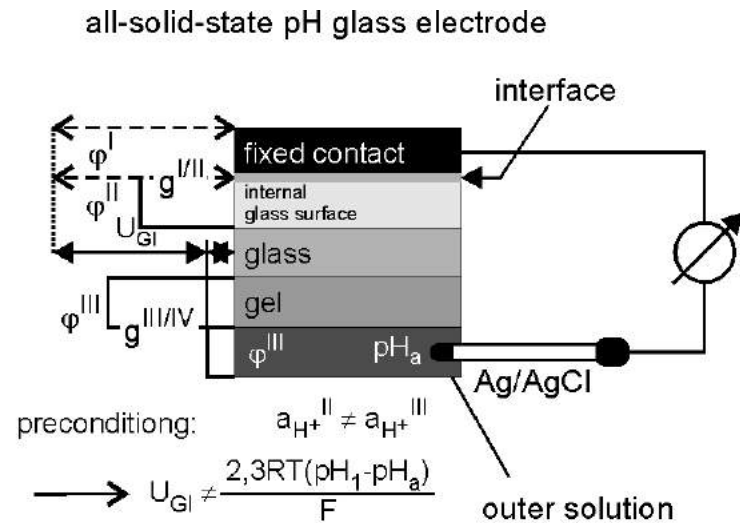
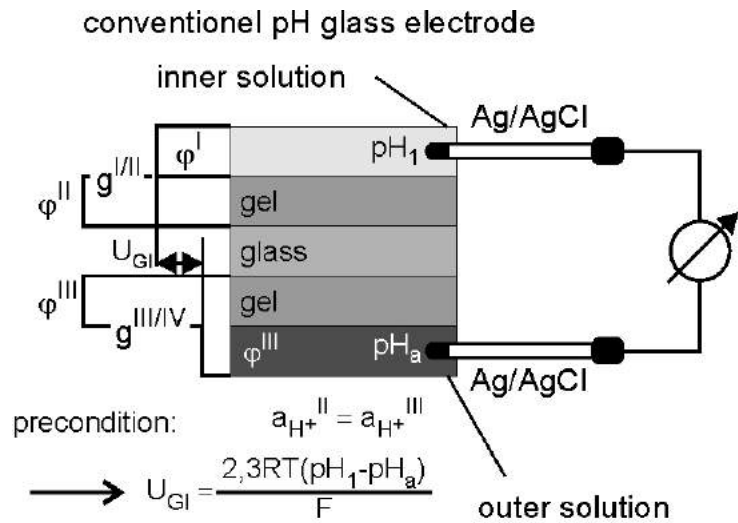

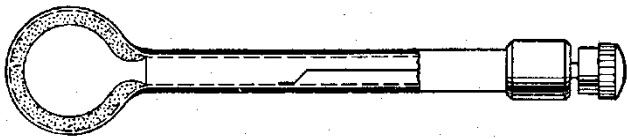

Jenaer flask electrode with metal coating and elastically supported membrane according to KRATZ



Metallised pressure resistant glass electrode according to LIENEWEG and NAUMANN

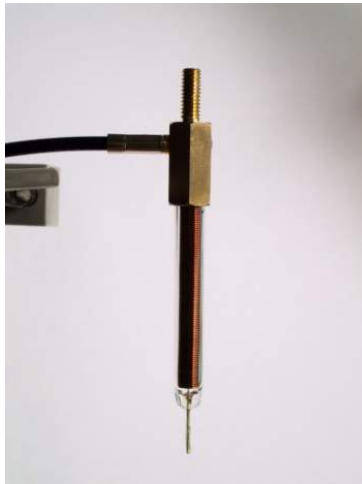
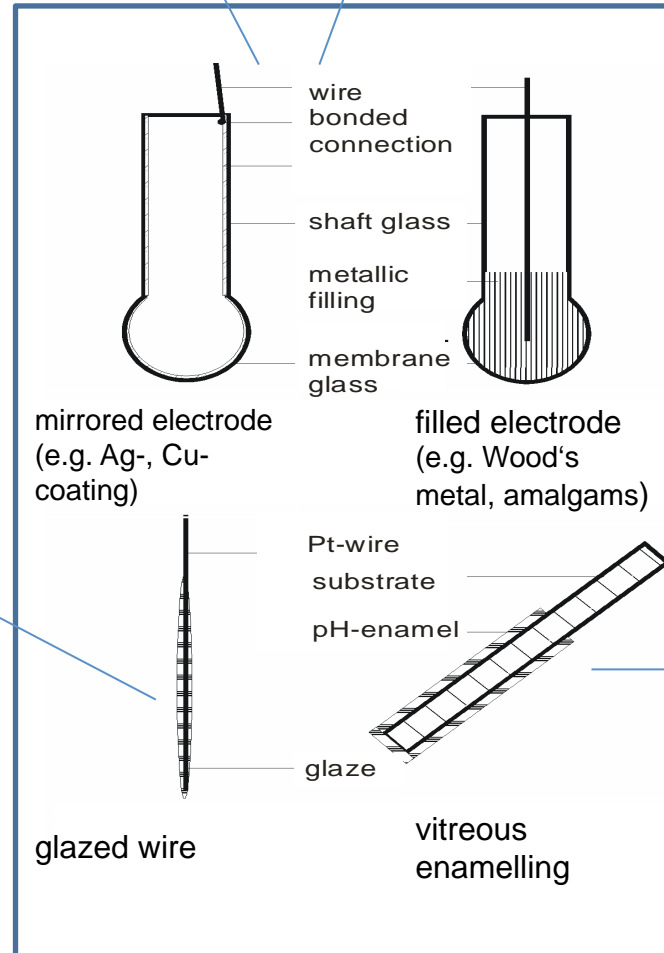

KSI



Pfaudler



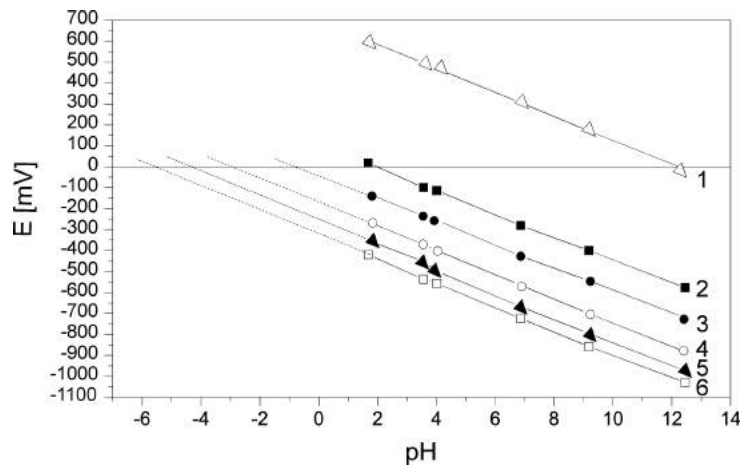
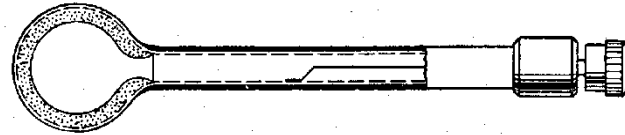

Electrode of all solid state pH electrodes vs. Ag/ AgCl, sat.. KCl at 25 °C in NBS- buffer solutions (solid contact: 1 ... Ag, 2 ... Pb/Bi-alloy, 3 ... WOODs metal, 4 ... Zn-alloy, 5 ... Sn-alloy, 6 ... Cd-alloy

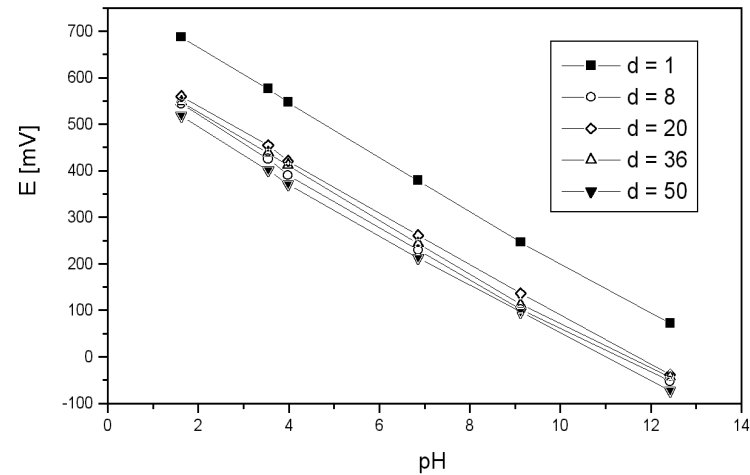

Electrode function of an all solid state pH glass electrode with silver contact vs. Ag/ AgCl, sat. KCl at 25 °C at several days d

Ion conducting glasses

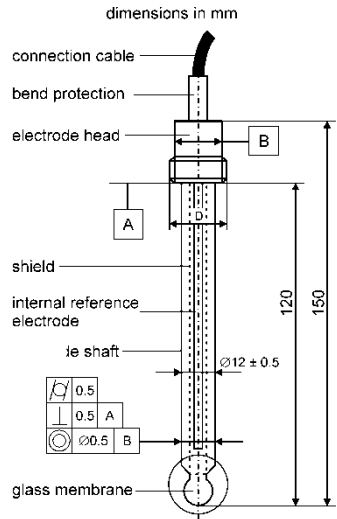

pH glass electrode according to GERMAN STANDARD DIN 19 263

Glass composition:
e.g. 72% SiO₂, 22% Na₂O; 6% CaO

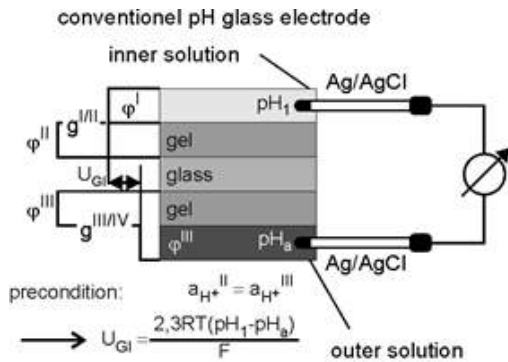

Metallized pressure resistant glass electrode according to LIENEWG and NAUMANN

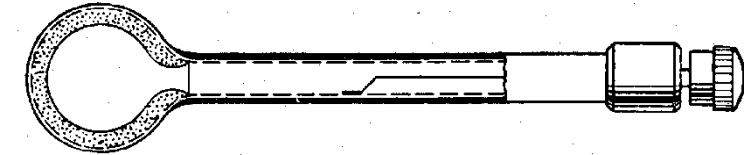

Jenaer flask electrode with metal coating and elastically supported membrane according to KRATZ

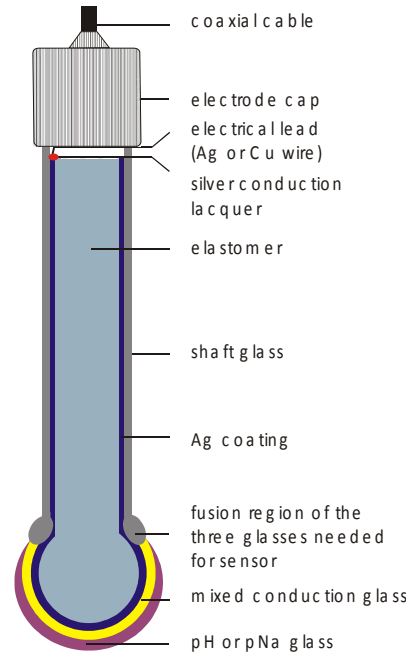

all-solid-state pH glass electrode

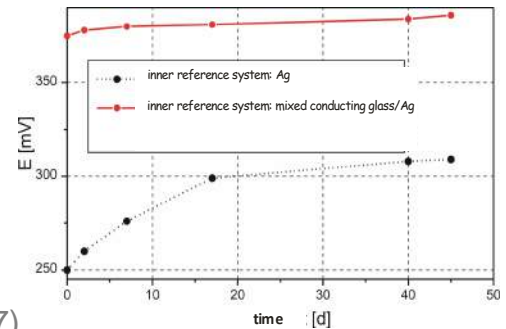
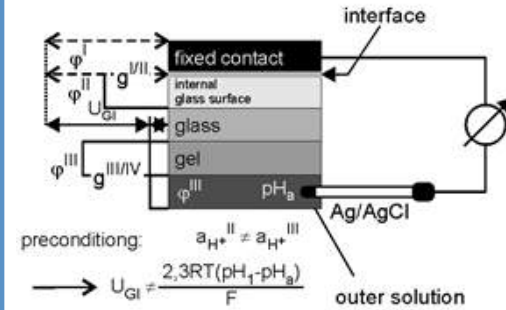

Vonau, W.; Kaden, H.: Glastech. Ber. Glass Sci. Technol. 70 (1997) 5, 155-160

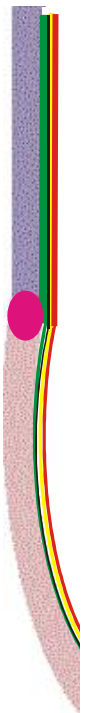

DTA exothermic →
← endothermic

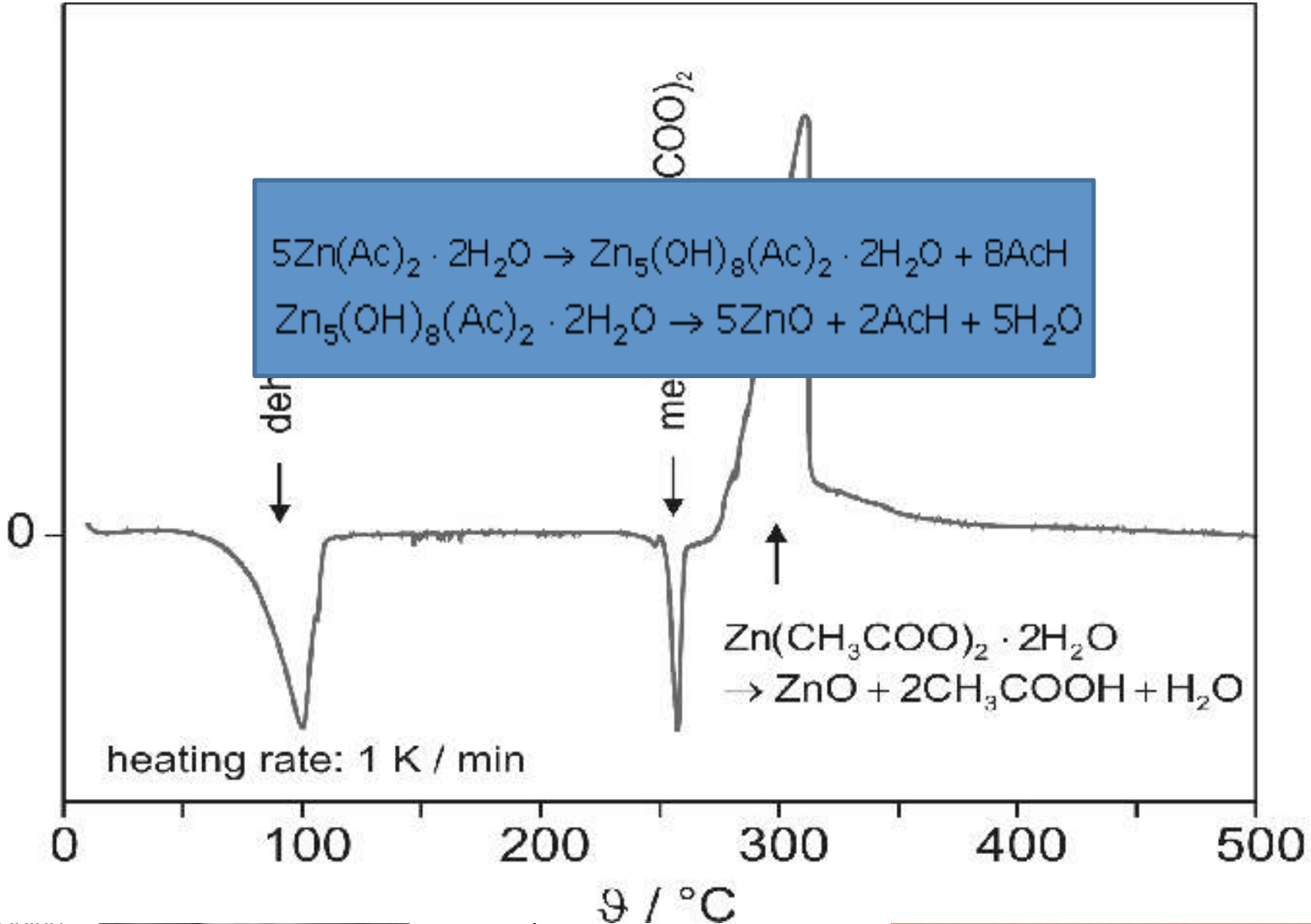

Bach
Spind
W.; G
10200

Reinecke, W.; Spindler, J.; Berthold, F.; Vonau, W.: MO 56 3 (2002) 20-24

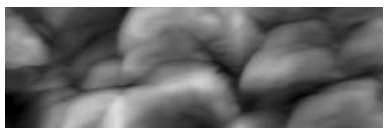

layer on top of the Corning 015 glass membrane (4 μm x 4 μm x 57 nm)

Vonau, W.; Gerlach, F.; Enseleit, U.; Spindler J.; Bachmann, T.: Journal of Solid State Electrochemistry. 13 (2009) 91-98

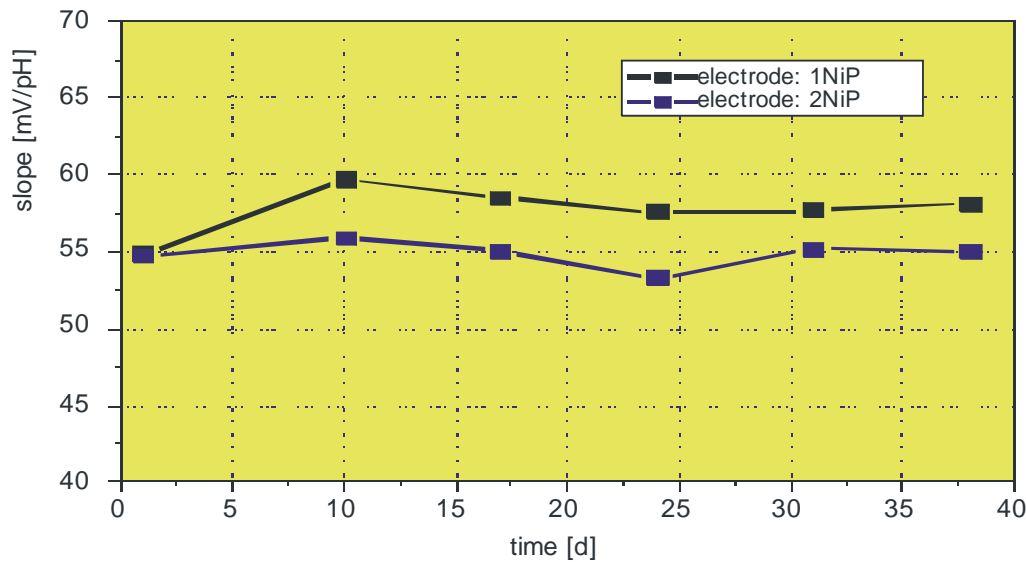

solid state pH flow-through electrodes

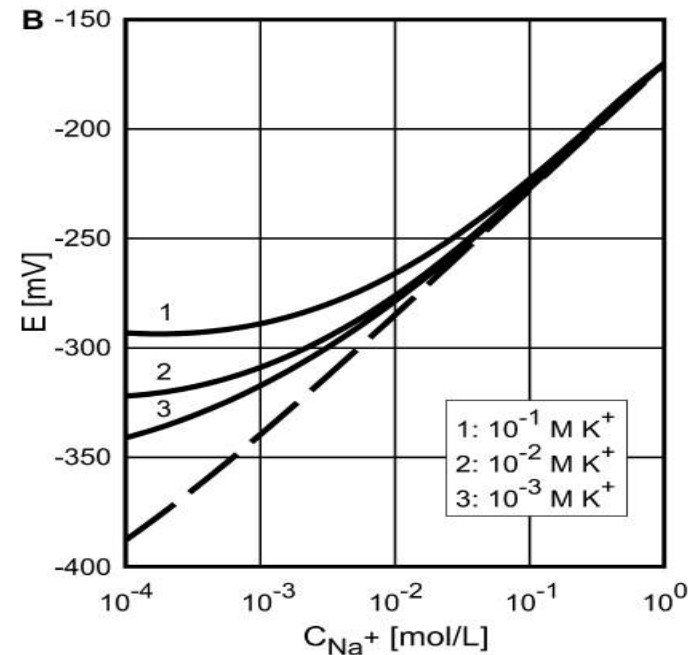

Vonau, W.; Enseleit, U.; Gerlach, F.; Bachmann, T.; Spindler, J.: Durchflussmessfühler zur Bestimmung von Ionenaktivitäten und Verfahren zu dessen Anwendung. german patent 10 2007 042 476.2

Vonau, W.; Gerlach, F.; Enseleit, U.; Bachmann, T.: Mehrparameter-Elektrode. german patent 10 2008 016 985.4

Vonau, W.; Enseleit, U.; Gerlach, F.: Electrochemistry Communications **10** (2008) 1355-135



sensor ass

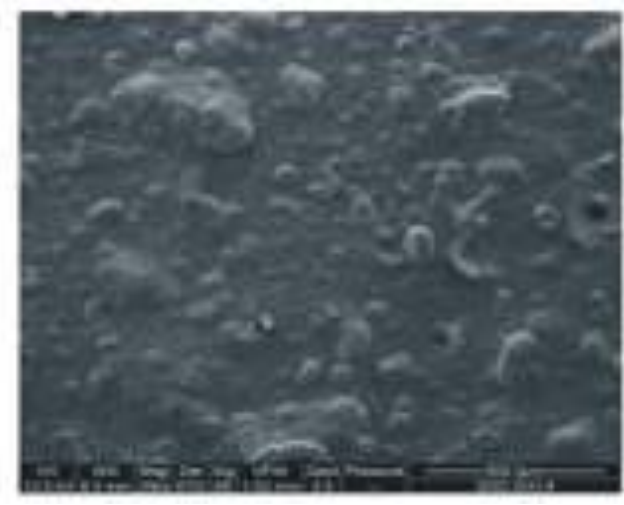
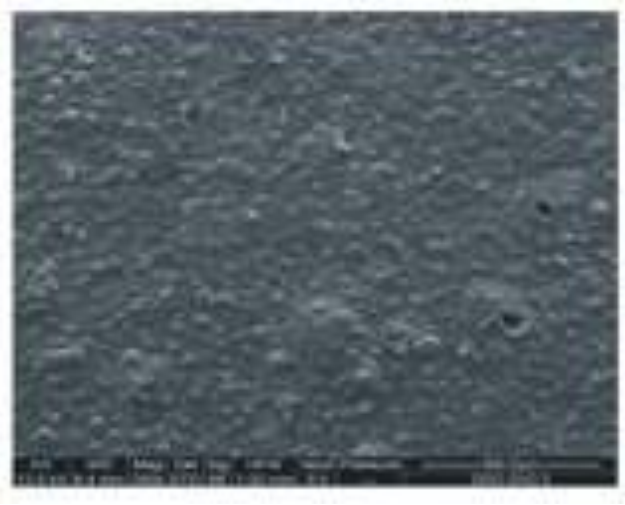
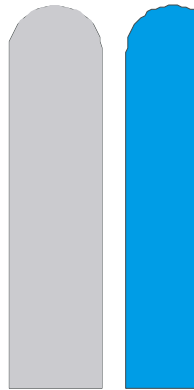

us $Zn(NO_3)_2$ solution

ulated steel substrates

- at.
- e to air
- a drying oven
- a muffle furnace

steel insulat

SEM shootings of the ZnO covered gold electrodes

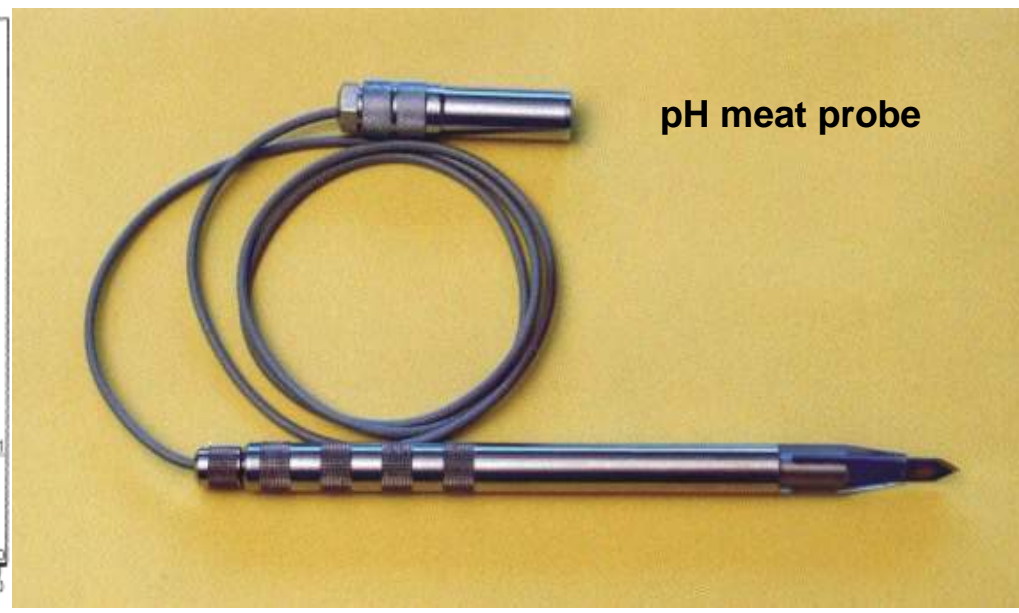
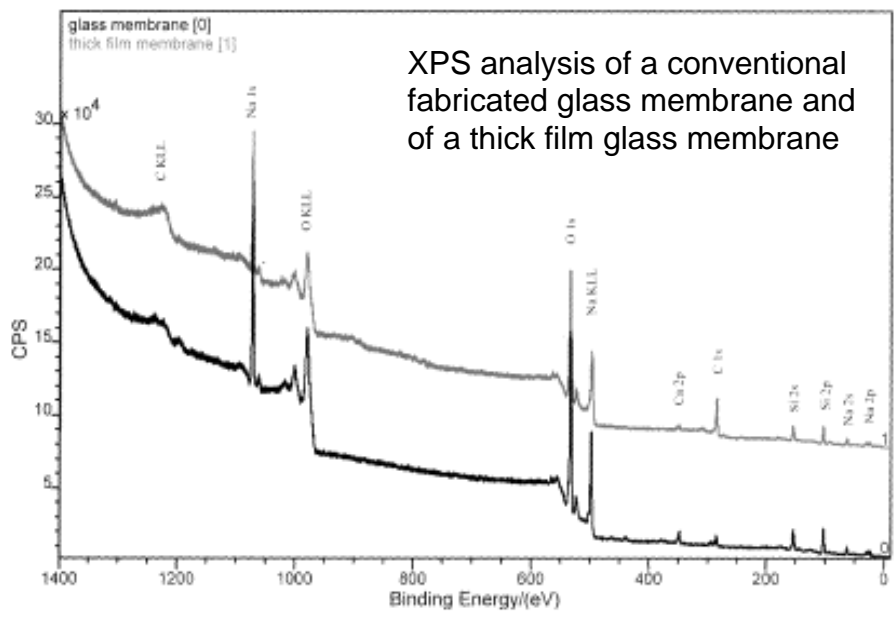

pH meat probe

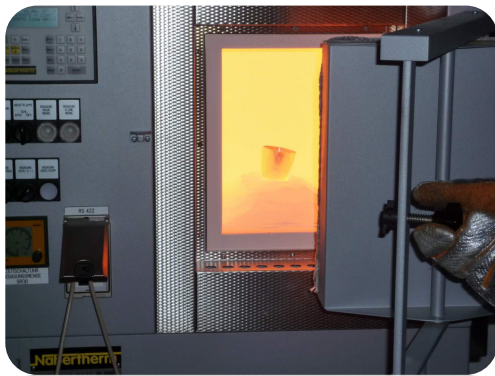

Glass melting process

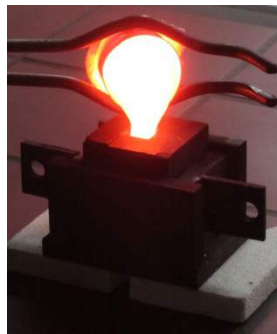

Two-piece graphite mold and of the glass pouring process

PLD pH sensor

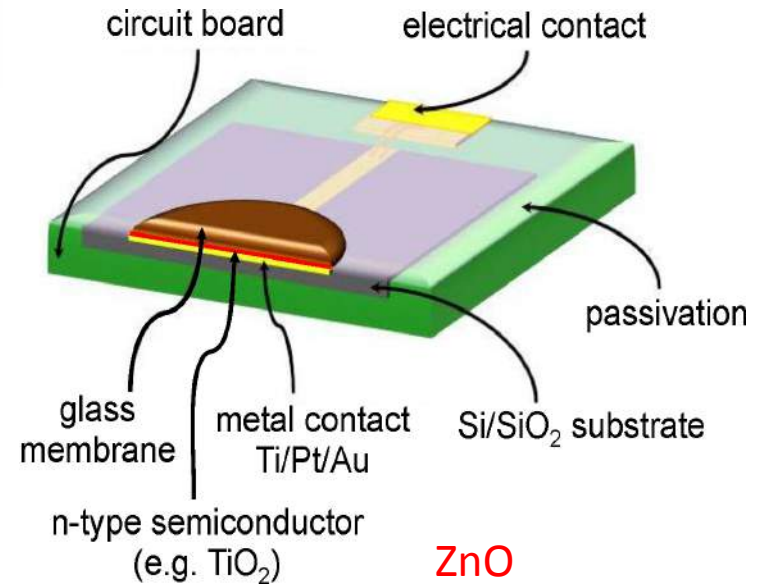

Cross-sectional schematic of the pH glass thin-film sensor attached to a printed circuit board, electrically contacted and encapsulated

W. Vonau, K. Ahlborn, F. Gerlach, H. Iken, W. Zander, J. Schubert, M.J. Schöning: PLD-Based Planar pH Sensor. The Fourth International Conference on Sensor Device Technologies and Applications SENSORDEVICES 2013, 25 – 31. August 2013 - Barcelona, Spain

Pulsed laser deposition (PLD)	
Power	1.2 J/cm ²
Wavelength	248 nm
Repetition rate	10 Hz
Ablation time	5 min
Pressure	2 x 10 ⁻² mbar N ₂
Temperature	RT

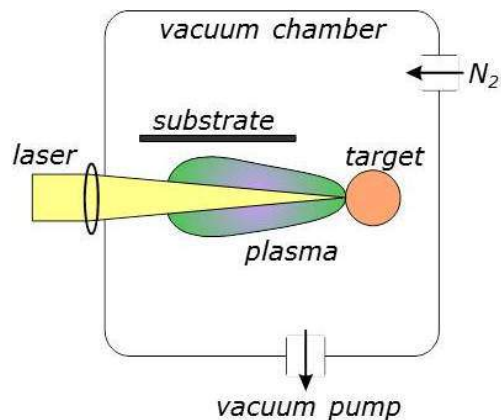

Ion conducting glasses

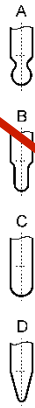
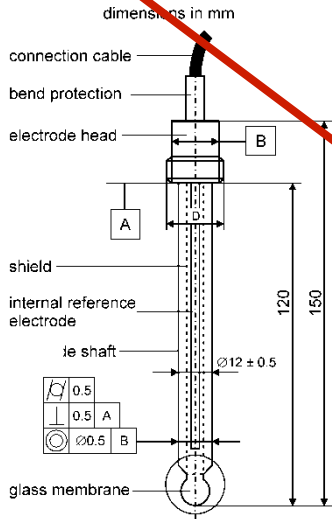

Metallized pressure resistant glass electrode according to LIENEWG and NAUMANN



Jenaer flask electrode with metal coating and elastically supported membrane according to KRATZ

pH glass electrode according to GERMAN STANDARD DIN 19 263

Glass composition:
e.g. 72% SiO₂, 22% Na₂O; 6% CaO

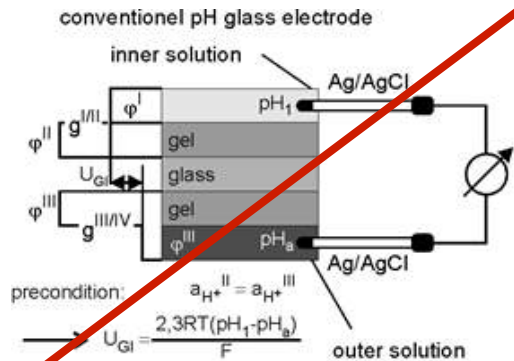

all-solid-state pH glass electrode

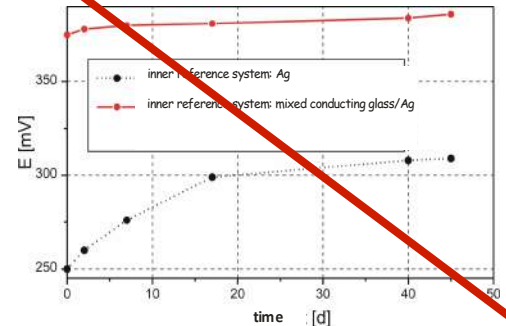
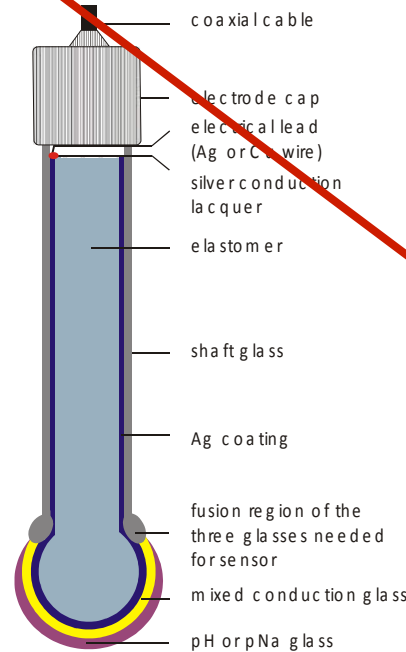
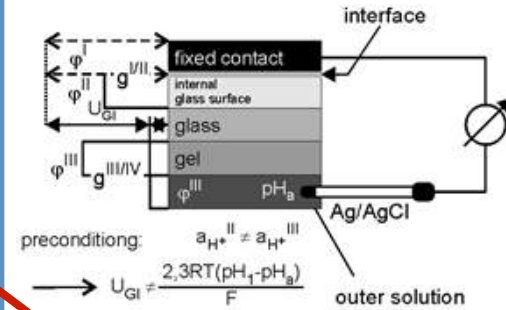

oxidic glasses

siliceous glasses:

quartz glass

sodium lime glass (pH, pNa, pK) 

semiconducting glass (redox potential)

mixtures of several basic glasses:

borosilicate glass

non-siliceous glasses:

borate glass

phosphate glass

non-oxidic glasses

saline glasses:

nitrate glass

fluoride glass

chalcogenide glasses 

(mono and polyvalent metal ions)

metallic glasses

Polymer glasses:

PS

PMMA

GLASS-FORMING SYSTEMS

An **amorphous solid** is a solid in which there is no long-range order of the positions of the atoms.

electrodes with amorphous membranes
(e.g. pH-glass, chalcogenide glass or redox glass)

Table 1. Main stages of work in the field of development of chemical sensors for solution analysis

Year	Author	Content of work	References	
			Analytical properties	Solid-state study
1906	Cremer	Influence of pH on emf in galvanic cell with glass membrane	[3]	
1909	Haber, Klemensiewicz	Development of glass electrodes	[4]	
1936	Beckman	Production of pH-meters	[5]	
1937	Nikolsky	Nikolsky equation and principles of ion-exchange theory of the glass electrodes	[6, 7]	
1961	Pungor	Development of solid-state heterogeneous crystalline ISE	[8]	
1966	Frant, Ross	Single crystalline lanthanum fluoride ISE	[9]	
1968	Simon	Liquid ISEs with neutral carriers in membrane	[10]	
1967	Ross	Liquid ISE with ion-exchange membrane	[11]	
1969	Guilbault, Montalvo	Potentiometric molecular-sensitive electrode (biosensor)	[12]	
1970	Bergveld	Development of ion-selective field effect transistor (ISFET)	[13]	
1971	Baker, Trachtenberg	Chalcogenide glasses as membrane materials for ISEs	[14]	
1986	Thorn EMI Microsensors	First commercial production of ISFETs	[15]	
1976	Emmerich	Enamel pH electrodes		
1983	Läppäouri	pH glass electrodes in thick film technology		

From: Vlasov YG, Fresenius Z Anal Chem (1989) 355:92-99

Table 2. Chalcogenide glass ion-selective sensors

Determined ion, X	Membrane composition	S, mV/pX	Detection limit, (mol/l)	pH	References	
					Analytical properties	Solid-state study
Ag ⁺	Ag-As-S	59	1 × 10 ⁻⁷	up to 6 mol/l HNO ₃	[24]	[25, 26]
Cu ²⁺	Ag-As-Se	29	1 × 10 ⁻⁷	up to 1 mol/l HNO ₃	[27, 28]	[29, 30]
	Cu-Ag-As-Se					
Pb ²⁺	PbI ₂ -Ag ₂ S-As ₂ S ₃	29	1 × 10 ⁻⁷	2-6	[31, 32, 35]	[33, 34, 36]
	PbS-Ag ₂ S-As ₂ S ₃					
Cd ²⁺	PbS-AgI-As ₂ S ₃	28	1 × 10 ⁻⁷	1-7	[37-38]	[37-39]
	CdS-Ag ₂ S-As ₂ S ₃					
Fe ³⁺	CdI ₂ -Ag ₂ S-As ₂ S ₃	58	5 × 10 ⁻⁵	1-2	[42]	[40-44]
Br ⁻	Ge ₂₈ Sb ₁₂ Se ₆₀ (Fe)	59.5	5 × 10 ⁻⁷	2-10	[45, 46, 49]	[46-48]

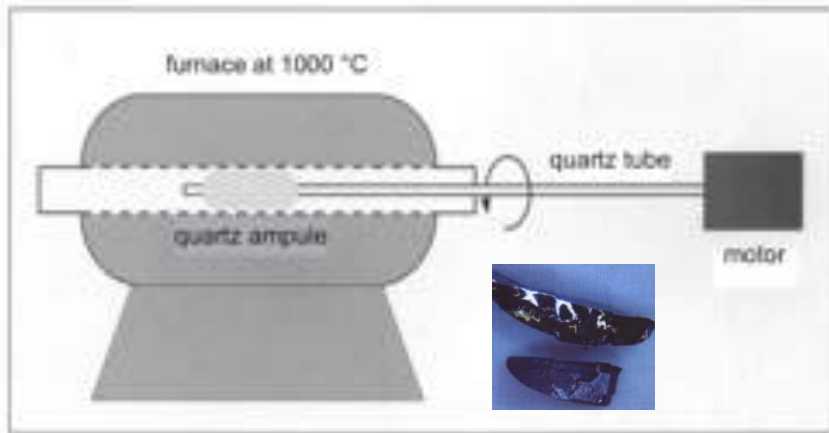

tube furnace to prepare chalcogenide glasses

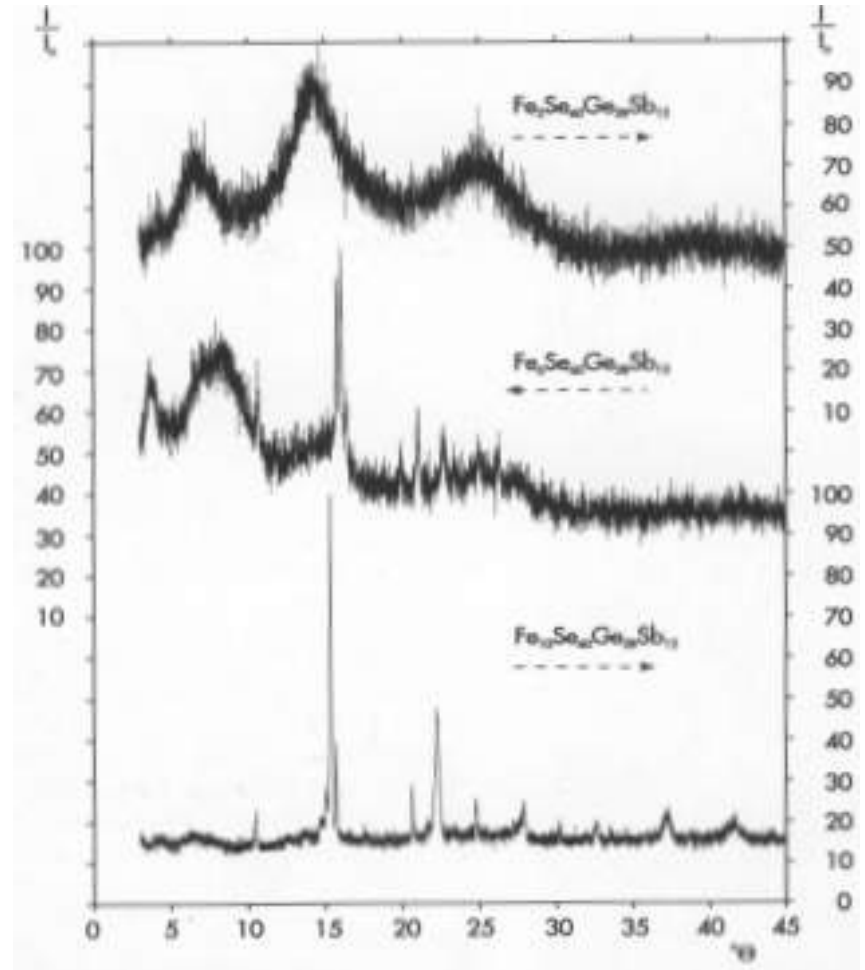

X-ray diffraction diagram

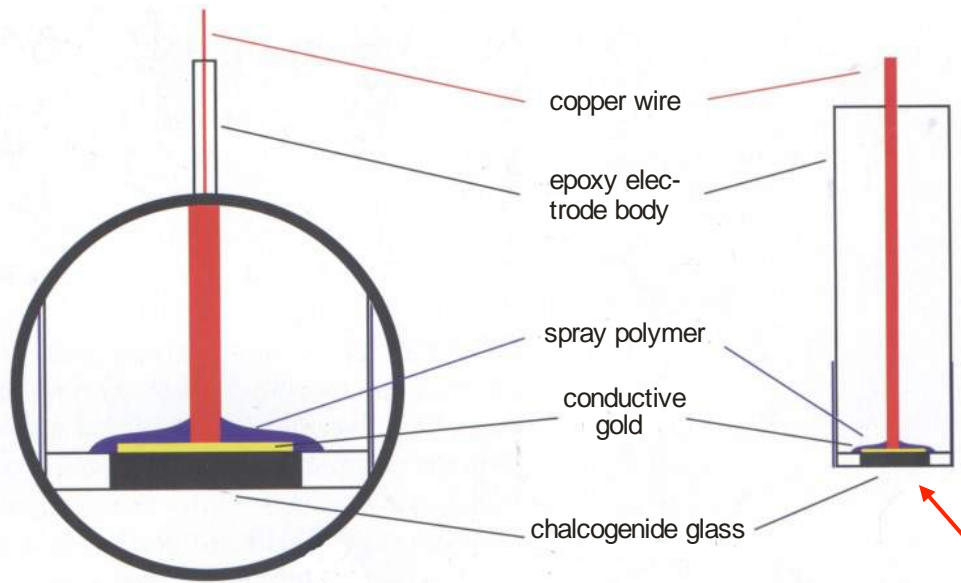

schematic drawing of a chalcogenide glass electrode according to the state of the art



photograph of a chalcogenide glass electrode

PLD – pulsed laser deposition

Chalcogenide glass membrane

- used glasses
 - CdSAgIAs₂S₃
 - PbSAgIAs₂S₃
 - CuAgAsSe
 - AgIAs₂S₃
- Deposition by laser ablation

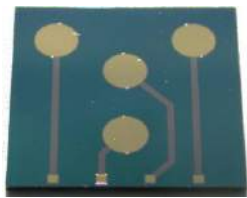
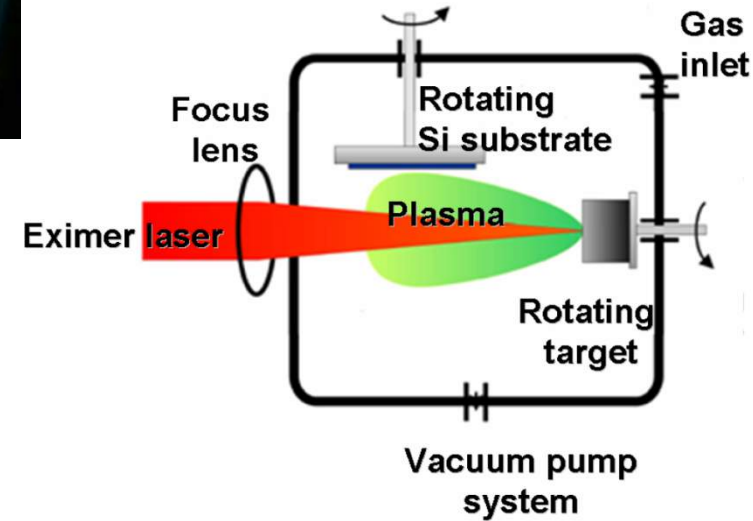

Si substrate with 4 electrodes



PLD-process



Si- substrate after PLD of the chalcogenide glass thin films and encapsulation

Chalcogenide glass

Chalcogenide-glass	Sensitivity [mV/dec]
CdSAgIAS ₂ S ₃	25,5 - 0,9
PbSAgIAS ₂ S ₃	23,9 - 2,1
AgIAS ₂ S ₃	46,1 - 4,5
CuAgAsSe	31,9 - 0,4

Chalcogenide-glass	Detection limit [mol/L]
CdSAgIAS ₂ S ₃	4×10^{-7}
PbSAgIAS ₂ S ₃	5×10^{-8}
AgIAS ₂ S ₃	2×10^{-7}
CuAgAsSe	4×10^{-8}

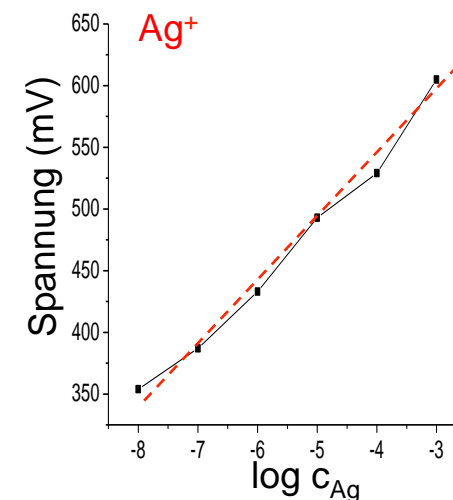
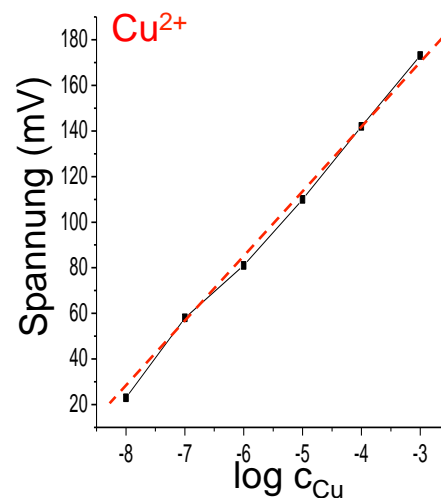
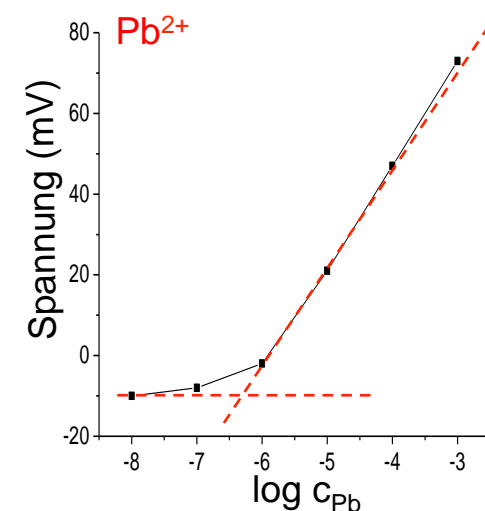
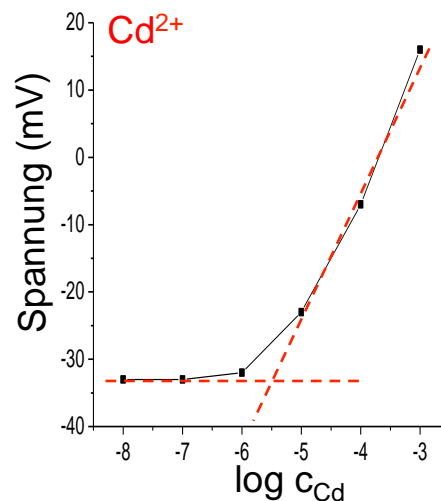

Schöning, M.J.; Kloock, J.P.: Electroanalysis 19(19-20) (2007) 2029-2038.

oxidic glasses

siliceous glasses:

quartz glass

sodium lime glass (pH, pNa, pK) 

semiconducting glass (redox potential)

mixtures of several basic glasses:

borosilicate glass

non-siliceous glasses:

borate glass

phosphate glass

Important applications for redox potential measurements



Drinking water



Swimming-pool water



Waste water

- Introduction
- New approach for redox potential measurement
- Fabrication of redox electrode glass and glass paste
incl. characterisation
- Fabrication of the electrodes
- Electrode test (laboratory)
- Field operation (Control of Process and Waste Waters)
- Outlook
- Conclusion
- Acknowledgement

glass	Na	K	Li	Fe	Ca	Si	addition
2	x	-	x	x (Fe ₂ O ₃)	-	x	-
3	x	-	-	x (Fe ₂ O ₃)	-	x	Al
4	x	-	x	x (Fe ₂ O ₃)	-	x	-
7 (7x)	x	-	x	x (Fe ₂ O ₃)	-	x	-
11	x	x	-	x (Fe ₂ O ₃)	-	x	-
12	x	x	-	x (Fe ₂ O ₃)x	-	x	-
14 (2x)	-	-	x	x (Fe ₂ O ₃)x	-	x	-
15	-	-	x	x (Fe ₂ O ₃)	-	x	-
16	x	-	x	x (Fe ₂ O ₃)	-	x	U
17 (3x)	-	-	x	x (Fe ₂ O ₃)	x	x	-
18	x	-	x	x (Fe ₂ O ₃ /Fe ₃ O ₄)	-	x	-
20	x	-	-	x (Fe ₂ O ₃)	x	x	-
21	x	-	-	x (Fe ₃ O ₄)	x	x	-
22	x	-	x	x (Fe ₃ O ₄)	-	x	-
23	x	-	x	x (Fe ₂ O ₃)	x	x	-
24	x	-	x	x (Fe ₂ O ₃)	x	x	-
25	x	-	x	x (Fe ₂ O ₃)	x	x	-

	Na	K	Li	Ti	Nb	Ta	Si
glass 1	x	-	x	x(TiO ₂)	x	x	x
glass 5	x	x	-	x(TiO ₂ /Ti ₂ O ₃)	x	-	x
glass 6	x	x	x	x(TiO ₂ /Ti ₂ O ₃)	x	x	x
glass 8 (2x)	x	-	x	x(TiO ₂ /Ti ₂ O ₃)	x	x	x
glass 9 (2x)	x	x	-	x(TiO ₂ /Ti ₂ O ₃)	x	-	x
glass 10 (3x)	x	x	-	x(TiO ₂ /Ti ₂ O ₃)	x	-	x
glass 13 (2x)	x	x	-	x(TiO ₂ /Ti ₂ O ₃)	x	-	x
glass 19	-	x	x	x(TiO ₂ /Ti ₂ O ₃)	x	x	x
glass 19 (Argon)	-	x	-	x(TiO ₂ /Ti ₂ O ₃)	x	x	x
glass 26	x	x	-	x(Ti ₂ O ₃)	x	-	x

Glass compositions

Melting of redox glass

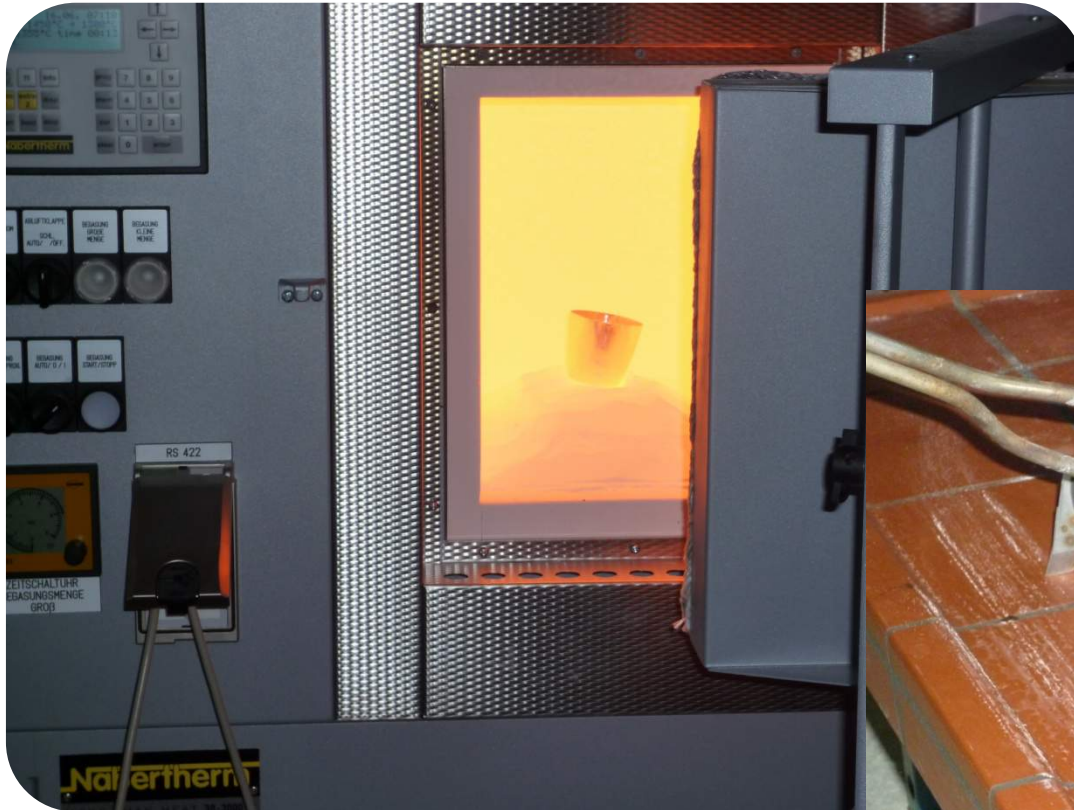



B.P. Nikolskij, M.M. Schulz: US 3 773 642 (197)

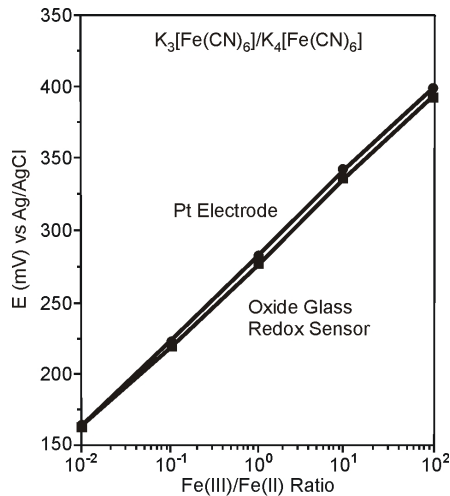

electrode function of a redox sensor from oxide glass and a platinum electrode in $K_{3,4}[Fe(CN)_6]$ - solutions

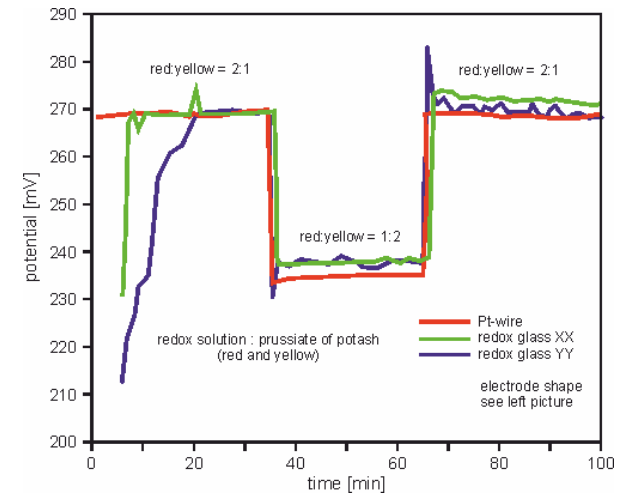
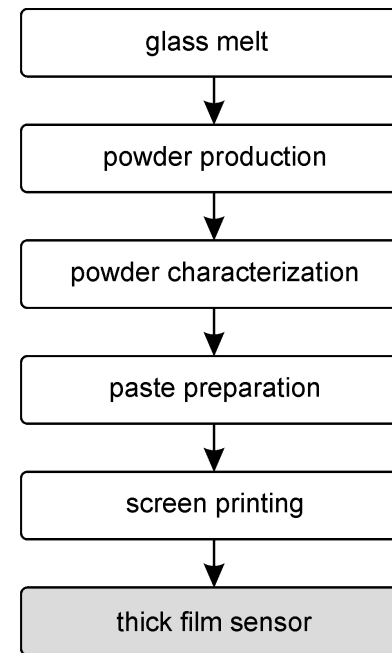
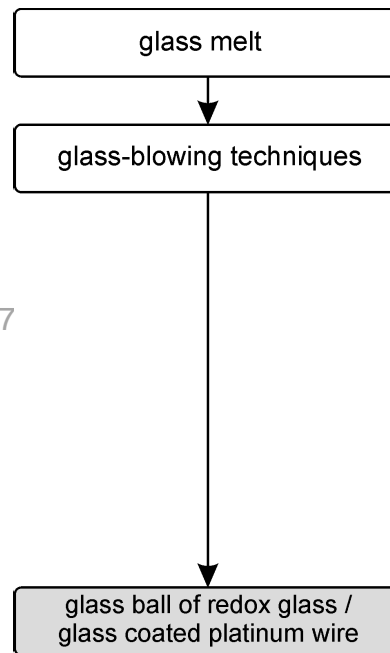

Electrode function of several redox electrodes

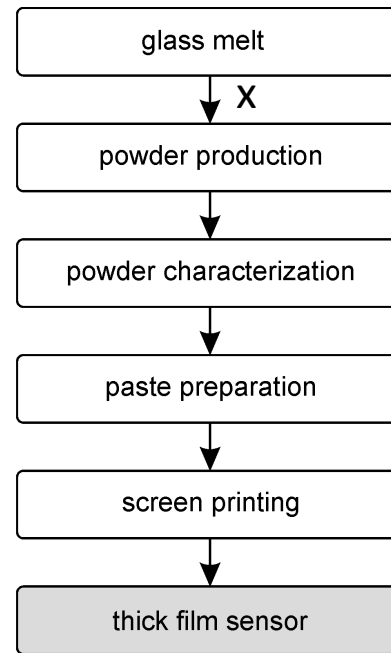
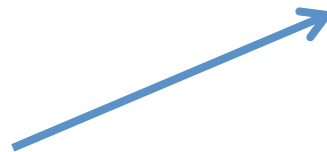

- glass was mechanically processed
- milled in a planetary ball mill for one hour
- glass powder was sieved through a mesh

X

Determination of the linear thermal coefficient of expansion



Dilatometer DIL 402C/4/G (Fa. Netzsch)

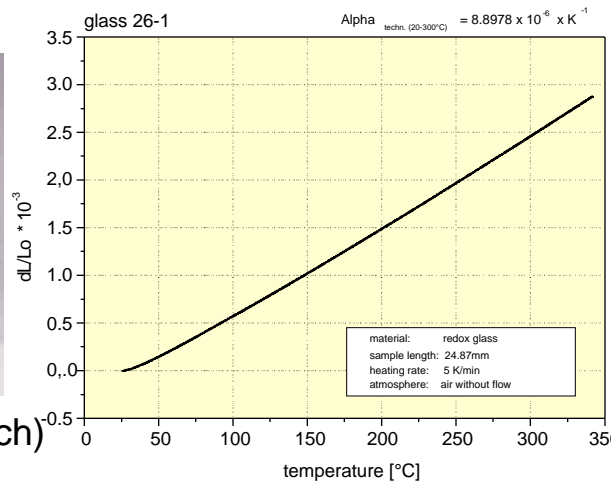

Thermographic investigations (Setsys TG-DTA 12 of SETARAM)

- low mass loss of the glasses
- even at 1200 °C still 99.5 % of the initial mass remained
- By means of DTA investigations several crystallisation peaks were identified, indicating that beside an amorphous phase redox glasses also possess crystal structures

Microscopic characterisation of Ti-containing glass powder

Determination of the liquidus temperature
(no crystalline devitrification above that temperature)

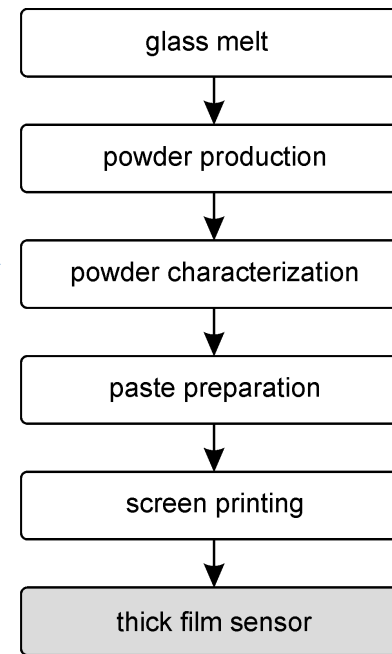

Ti-glass	liquidus temperature [°C]	crystal phase
8	1295	unknown
9	1000	rutil
10	1210	rutil
13	1255	rutil
26	1260	rutil

Granulometric analysis of glass powder

Brunauer-Emmet-Teller (BET) surface area by analysis of gas adsorption

Particle size by laser diffraction methods

Glas-Nr.	BET surface [m ² /g]	particle size:[μm]
7	0.12	1.5
8	0.30	1.7
9	0.38	1.5
10	0.13	1.7
11	0.17	4.0
13	0.14	1.1
14	0.13	1.4
17	0.18	1.0
19	0.18	1.5
22	0.13	0.4
23	0.21	1.4
24	0.13	1.1
25	0.14	0.8
26	0.13	1.7

X-ray characterisation

XRD-diffractograms at Ti-containing redox glass powder

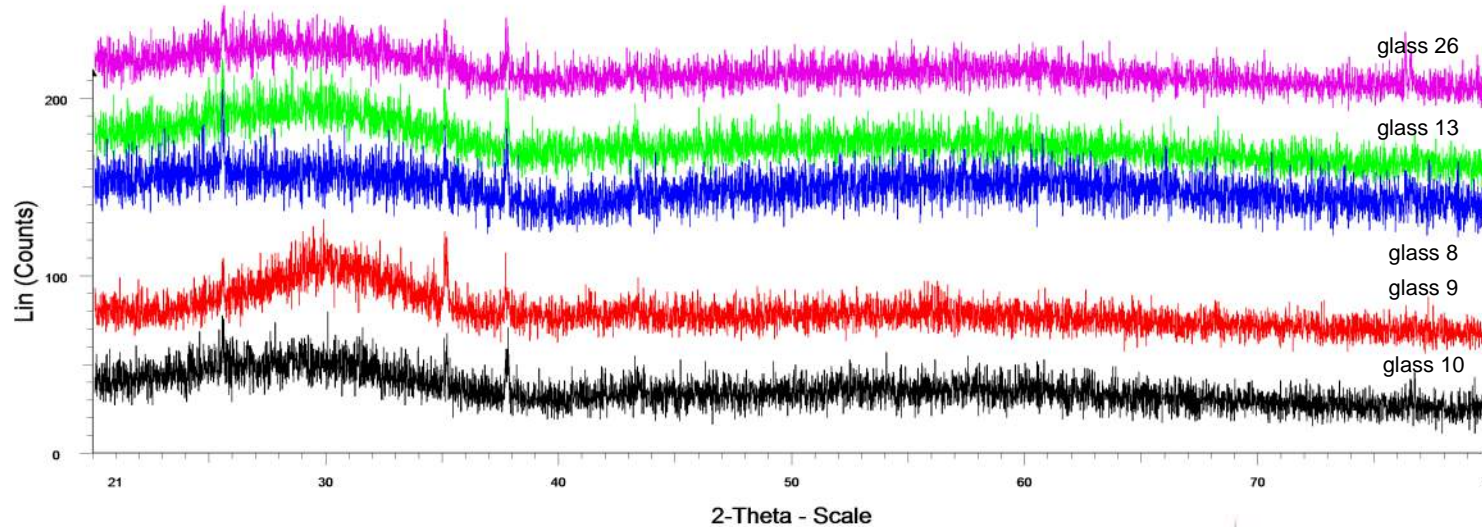

XRD-diffractograms at Fe-containing redox glass powder

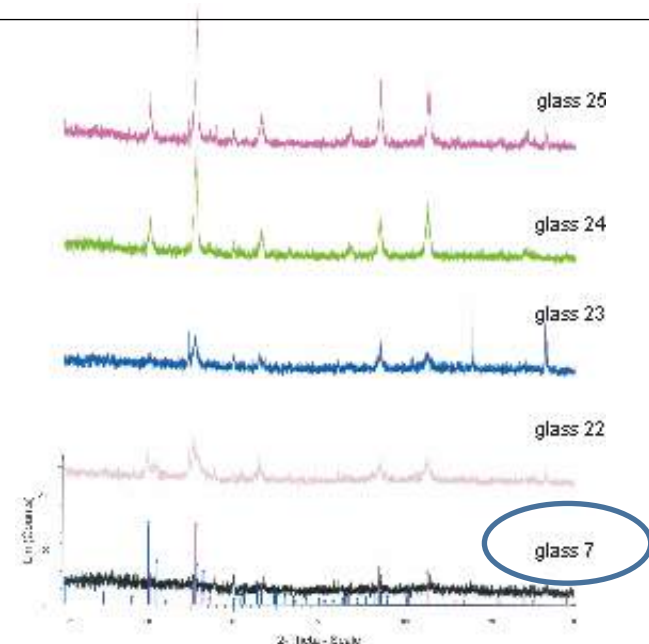

Powder diffractometer XRD 7 from SEIFERT (GE Inspection) with a $\text{CuK}\alpha$ radiation of a wave length of 1.5418 \AA was used. The X-ray tube was operated with 40 kV and 40 mA. The measurements were performed with a counting period between 8 and 30 seconds per test point and a step size of 0.03° .

Measurements of the catalytic activity

- Carried out in a controllable, temperature programmable tube furnace of HTM REETZ
- Within the oven a quartz vessel (\varnothing 15 mm) was located.
- Gas: synthetic air with 1000 ppm hydrogen
- Reaction product water is investigated with FTIR spectroscopy (NICOLET 8700 of THERMO SCIENTIFIC)

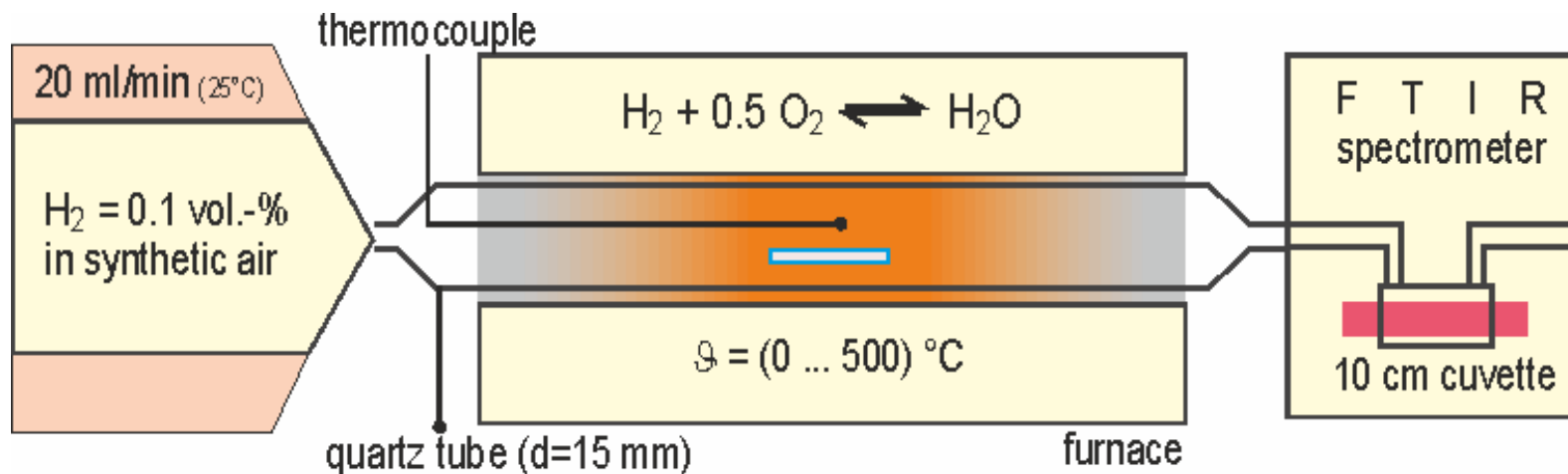

Results

Measurements of the catalytic activity (glass A)

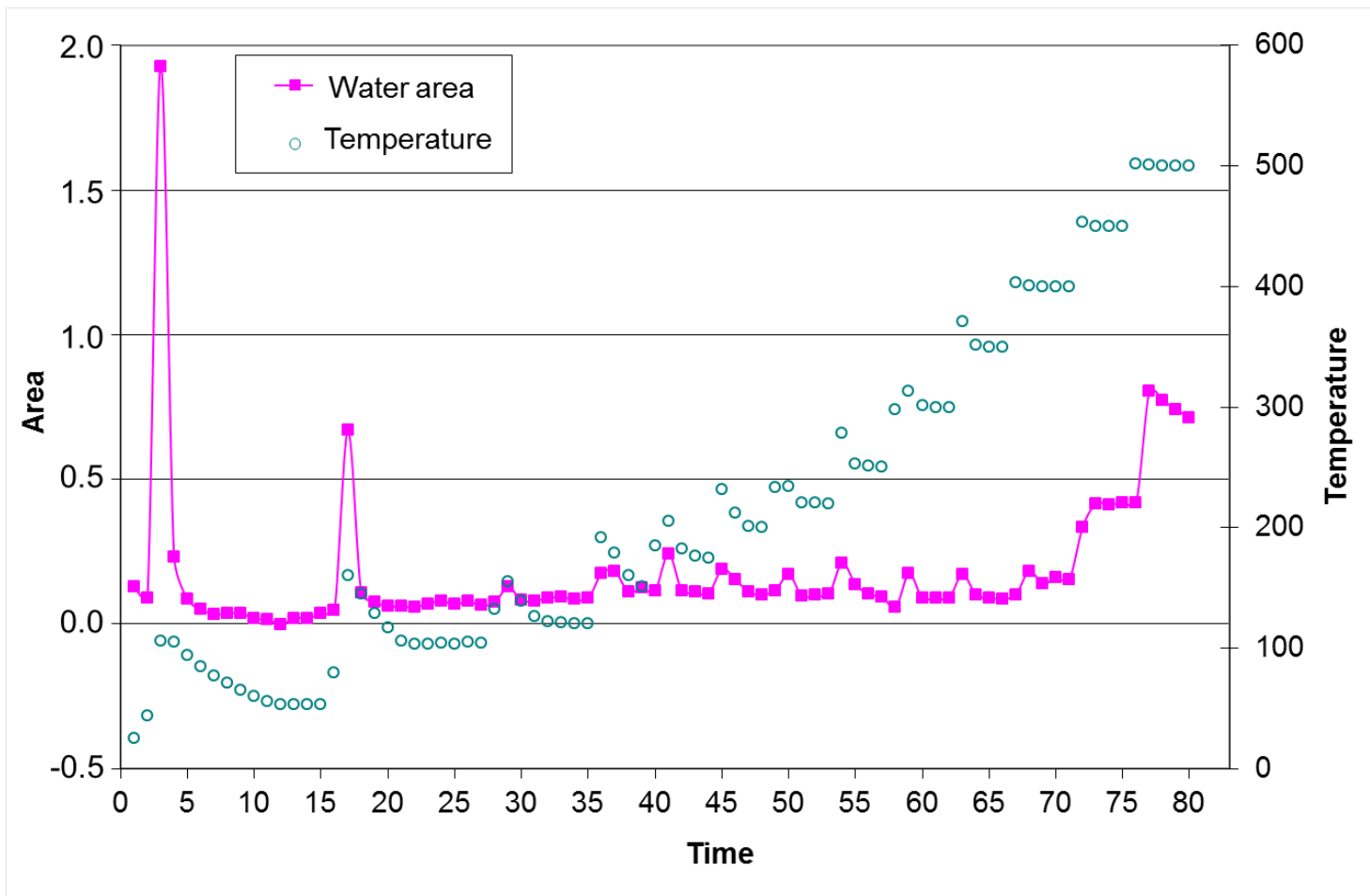

- powder was weighted, blended with the identical amount of a terpineol containing binder
- mixed again in the planetary ball mill for further 16 hours

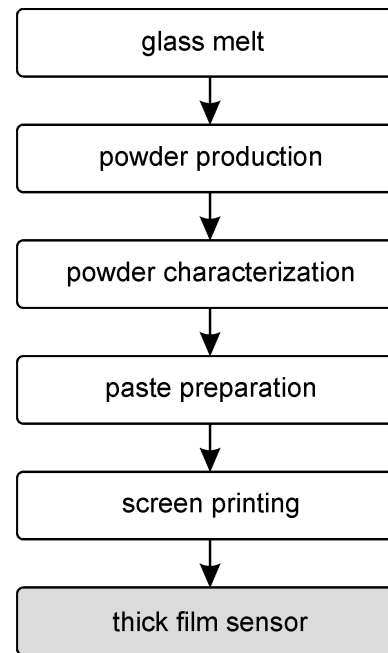

Optimised sintering temperature



SEM shooting of a thick film of glass A

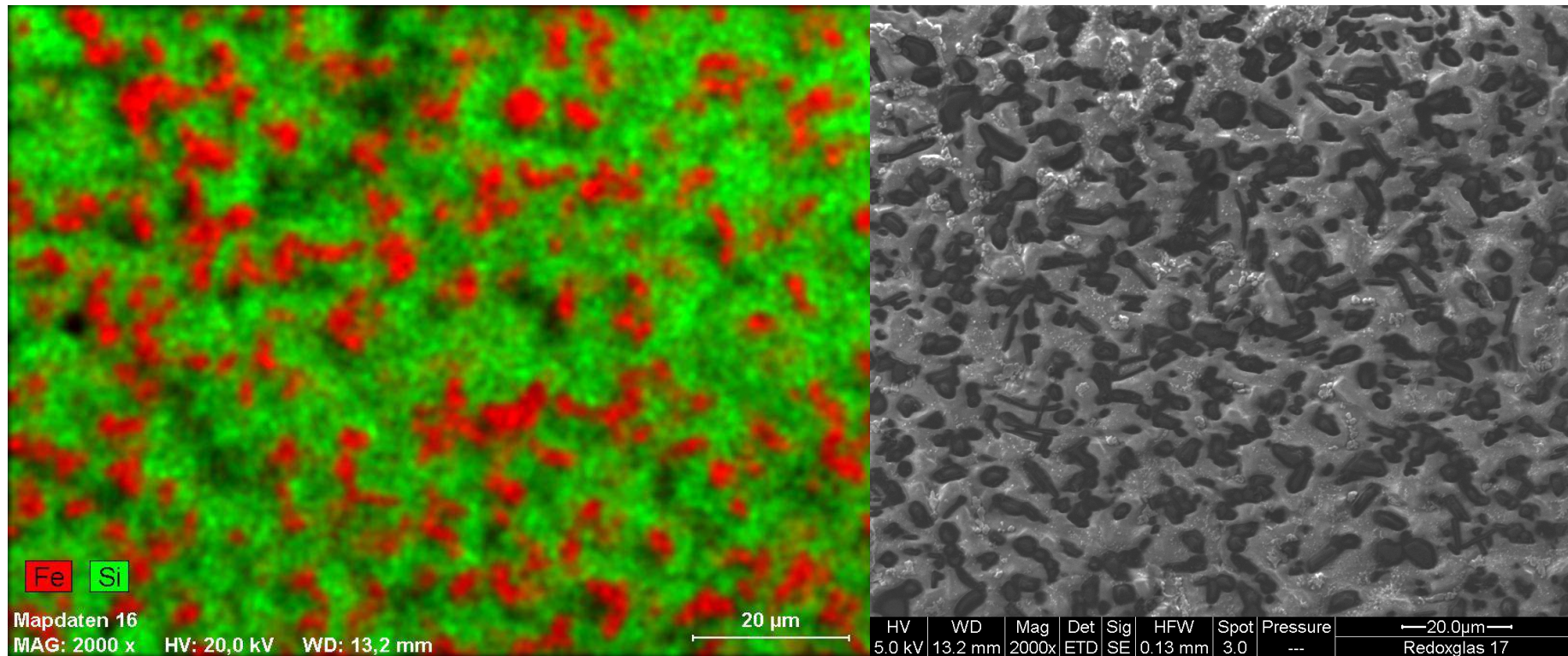

EDX spectrum of a thick film of glass A

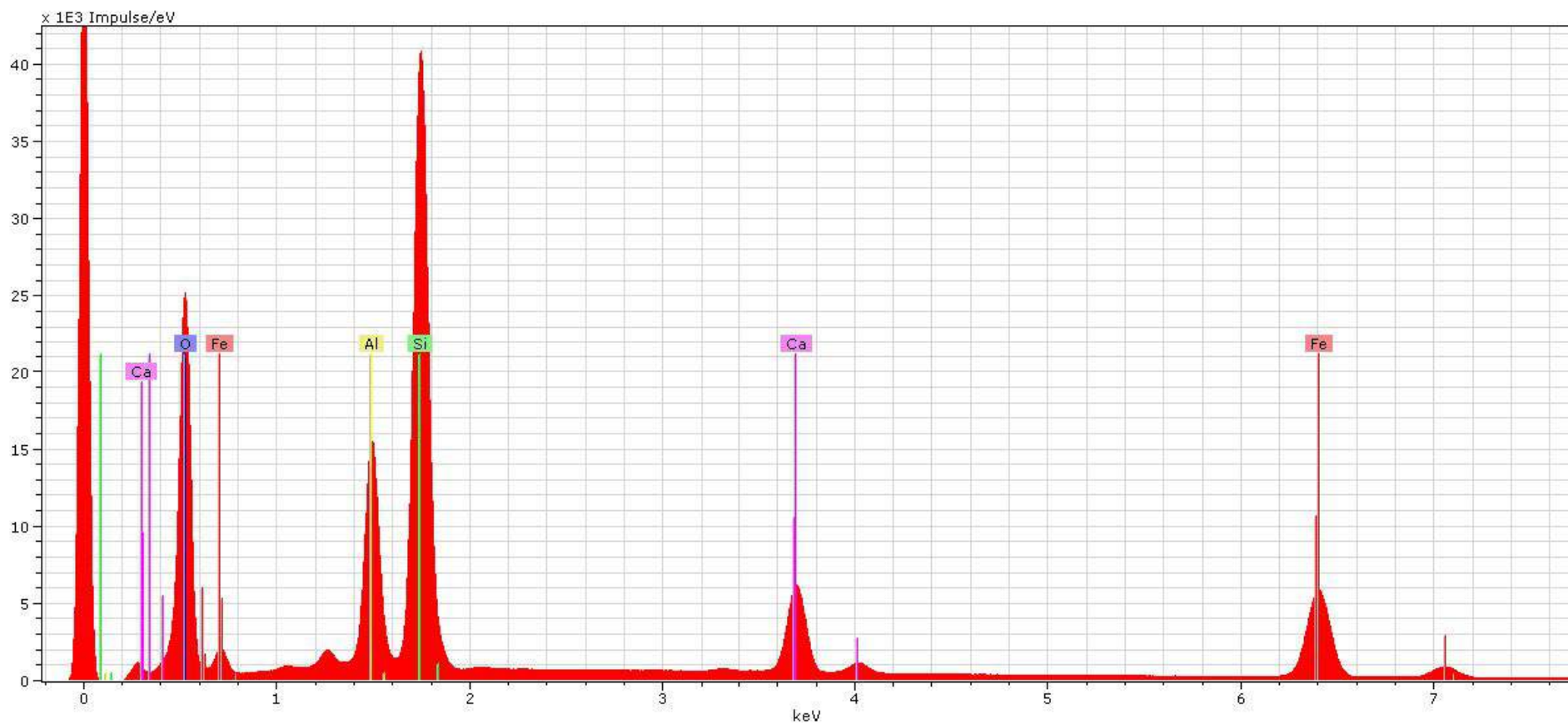

Comparison of X-ray diffractograms on powder and thick film paste of redox glass

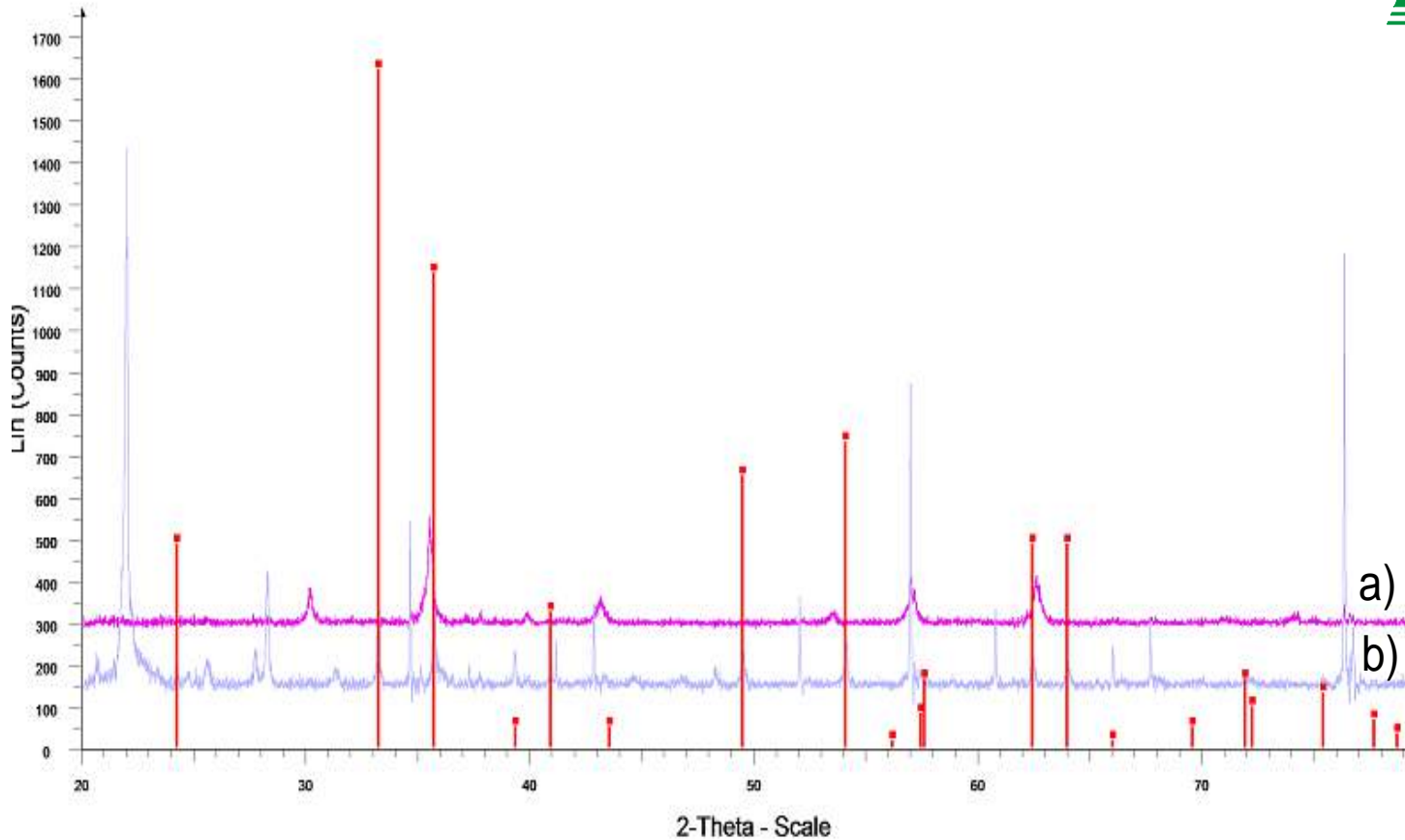

- a) glass powder A
- b) glass thick film A

red:
expected peak positions for Fe_2O_3

The degree of recrystallisation increased in the order initial glass - glass powder - thick film glass electrode membrane!

- Introduction
- New approach for redox potential measurement
- Fabrication of redox electrode glass and glass paste
incl. characterisation
- **Fabrication of the electrodes**
- Electrode test (laboratory)
- Field operation (Control of Process
and Waste Waters)
- Outlook
- Conclusion
- Acknowledgement

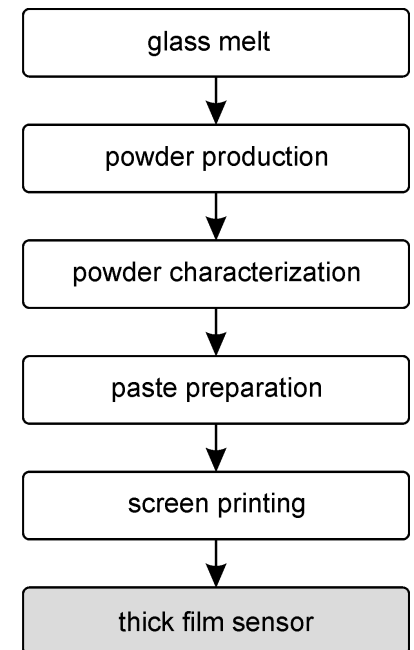

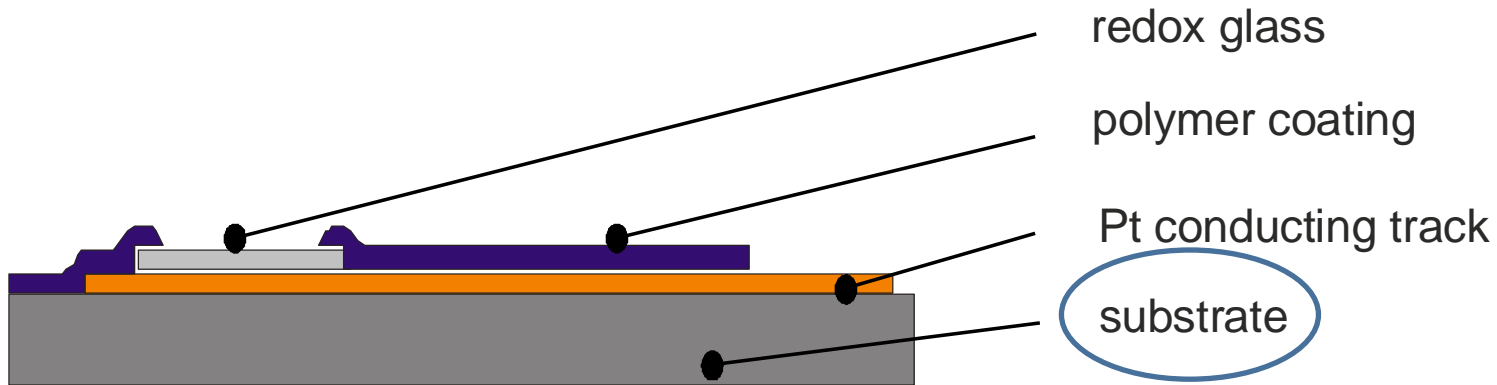

glass Nr.	α [$10^{-6}/K$]	glass Nr.	α [$10^{-6}/K$]	glass Nr.	α [$10^{-6}/K$]	glass Nr.	α [$10^{-6}/K$]
5	7.02	11	7.02	16	8.59	21	7.08
6	7.48	12	9.44	17 - Fe	7.42	22 - Fe	8.80
7 - Fe	8.73	13 - Ti	8.77	18	8.87	23 - Fe	8.23
8 - Ti	7.73	14	10.05	19	8.11	24 - Fe	6.95
9 - Ti	n.b.	15	9.48	20	6.87	25 - Fe	7.50
10 - Ti	8.98					26 - Ti	8.89

Al_2O_3 α [$10^{-6}/K$]: 8.5

Layout development/ sensor confectioning

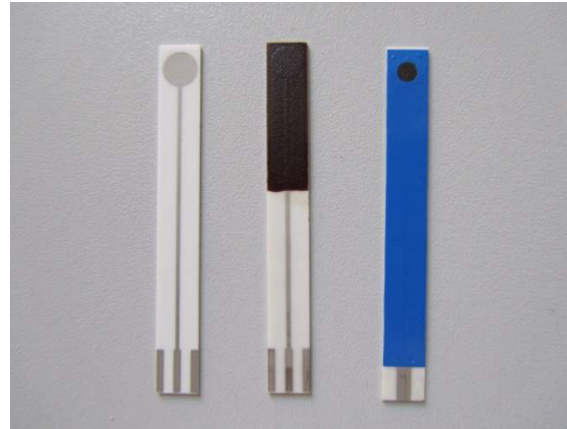
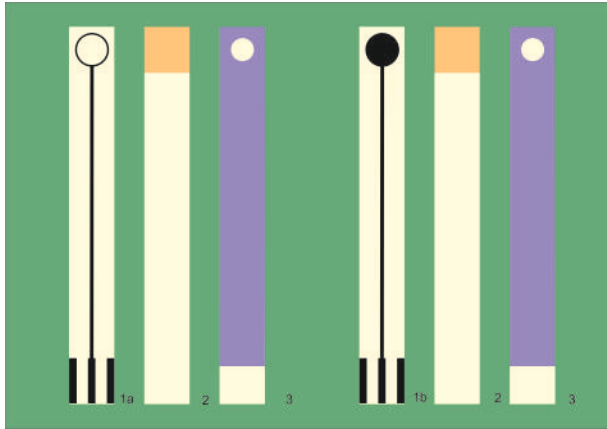

single electrode in a flow-through probe

multisensor

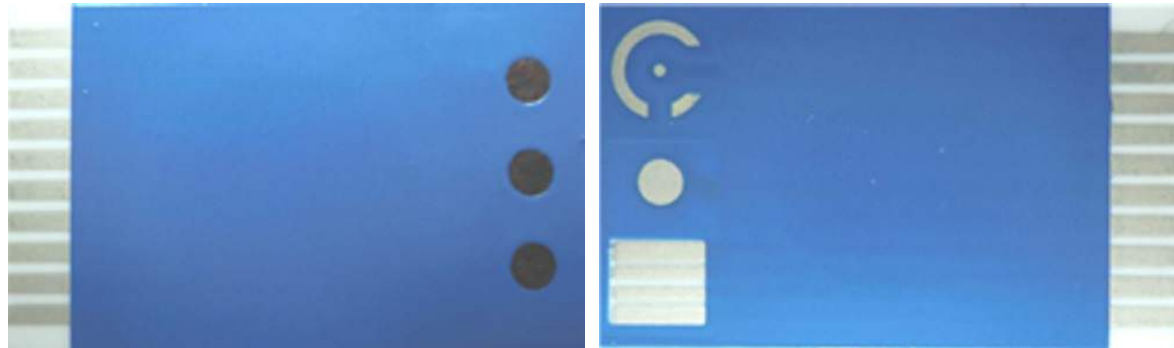
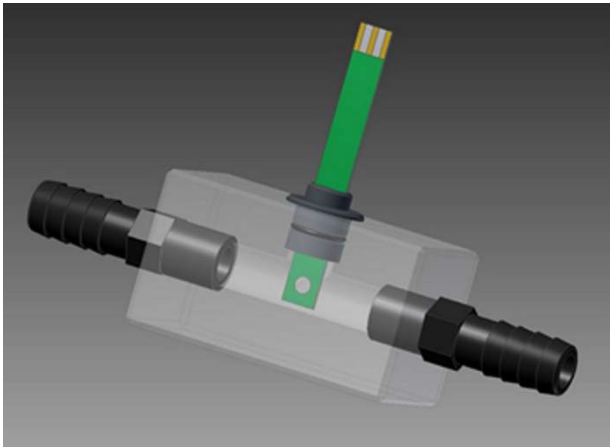

front view

back view

- Introduction
- New approach for redox potential measurement
- Fabrication of redox electrode glass and glass paste
incl. characterisation
- Fabrication of the electrodes
- **Electrode test (laboratory)**
- Field operation (Control of Process and Waste Waters)
- Outlook
- Conclusion
- Acknowledgement

Impedance measurement

- To compare the internal resistances of the different redox glass electrodes
- Ag/AgCl reference electrode, platinum counter electrode and the redox glass electrode as working electrode were inserted in a mixture of $K_3[Fe(CN)_6]$ and $K_4[Fe(CN)_6]$ (ratio of ingredients: 2:1) in a measuring chamber acting as Faraday cage
- Voltage amplitude: 20 mV; measuring range 10 kHz – 100 mHz.
- VersaSTAT 3; software VersaStudio of PRINCETON APPLIED Research

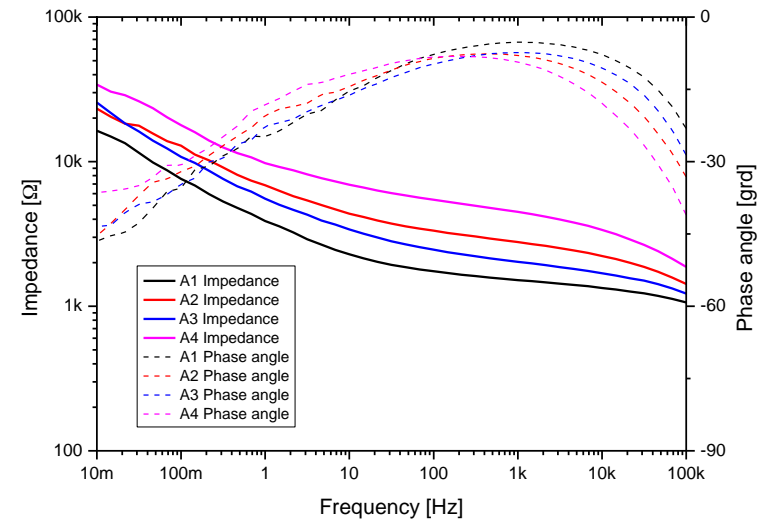
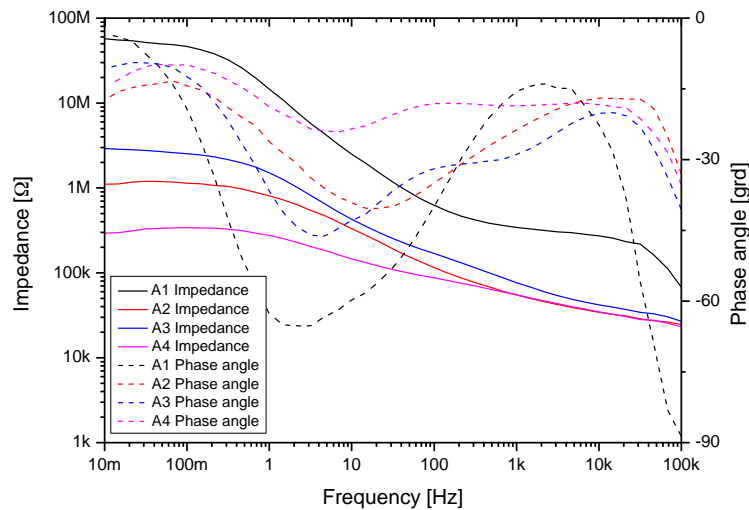

coated Pt wire (glass A)

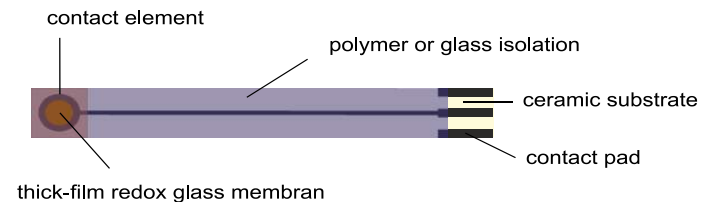

thick film electrode (glass A)

Redox potential measurement with different conventional electrodes compared to a redox glass electrode (glass A)

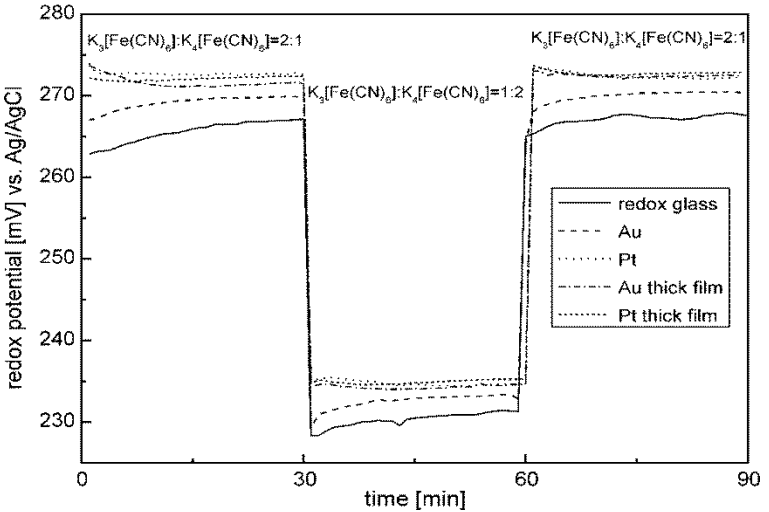

pH dependency of redox potential

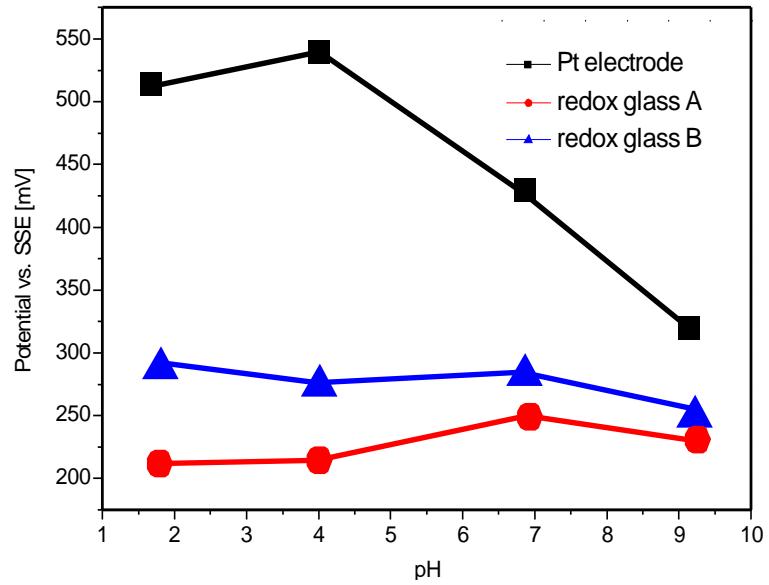

Cyclic voltammetry glass A

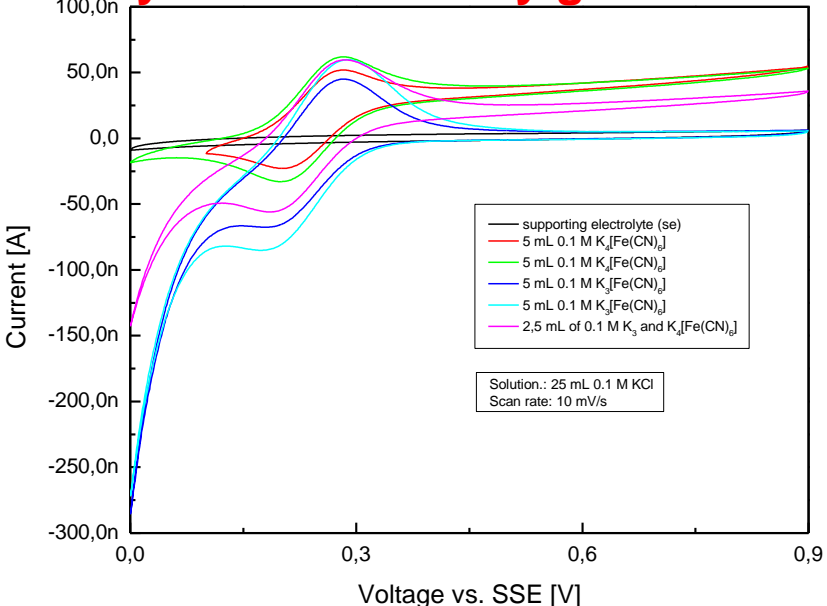

- Introduction
- New approach for redox potential measurement
- Fabrication of redox electrode glass and glass paste
incl. characterisation
- Fabrication of the electrodes
- Electrode test (laboratory)
- **Field operation (Control of Process and Waste Waters)**
- Outlook
- Conclusion
- Acknowledgement

Situation and problems

- In the production of paper, water is required for auxiliary and cleaning purposes and it is often used several times.
- In reducing the volume of waste water the proportion of soluble substances increases, creating an undesirable nutrient-rich habitat for micro-organisms (slime + biofilm growth).
- The problem is treated effectively by an optimised application of biocide active substances.
- For the controlled addition of peroxide based biocides to suppress the slime growth in the process water, redox potential determination can make an essential contribution, whereby the complicated composition of the medium does not require the use of precious metal electrodes.
- For the assessment of the determined redox potentials it has to be taken in account that beside the concentration of the biocides the position-dependent amount of oxygen and/or the pH values have a significant influence on the sensor signal. These parameters should additionally be determined and considered for the evaluation of the redox potentials.

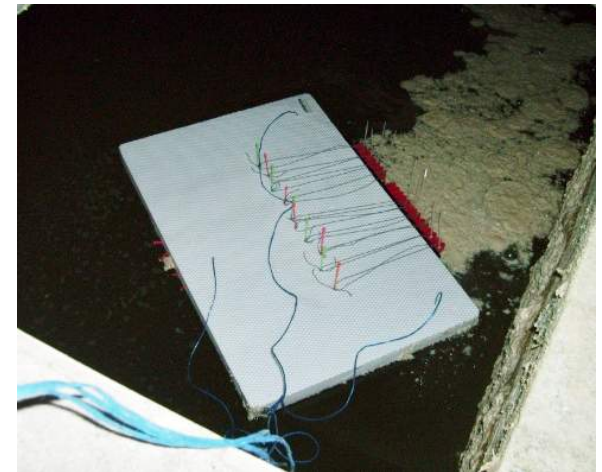



Laboratory setup (circuit water)

model solution:
 $\text{CaCl}_2 \cdot 6 \text{H}_2\text{O}$, $\text{Na}_2\text{SO}_4 \cdot 10 \text{H}_2\text{O}$,
 starch and NaCl

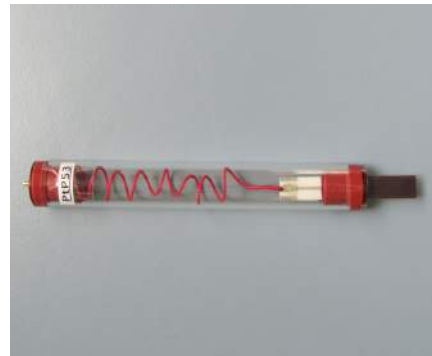
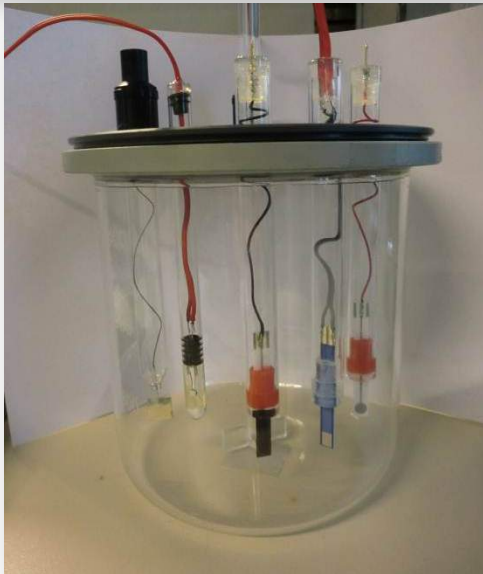

Redox glass electrode

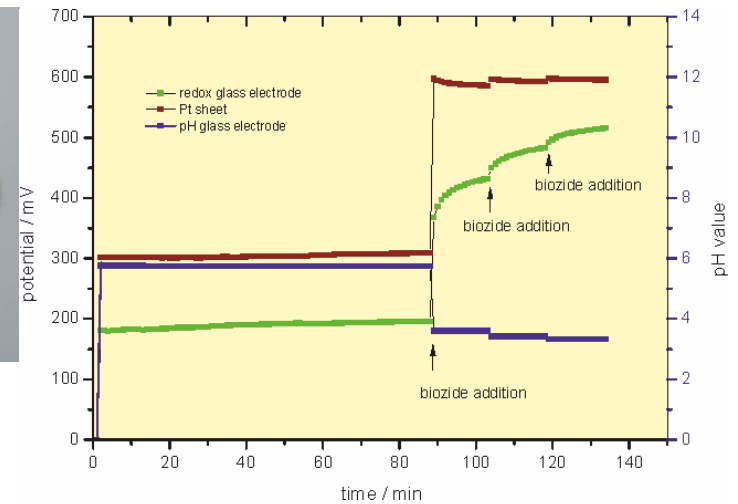

Redox potential depending on biozide (peracetic acid) addition in process water of the paper industry

- 2x redox potential
- chlorine
- oxygen
- conductivity
- pH value

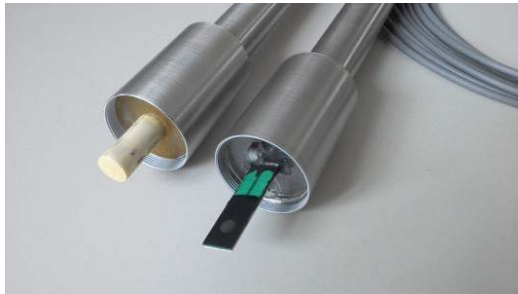

Glass based redox potential probe (right) and polymer based reference electrode (left) for the industrial application



Measuring system for the monitoring of process water, consisting of control box (a), measuring lance (b) and measuring barrel (c)



Multi sensor system to control process water of the paper industry left contaminated: right after cleaning with compressed air



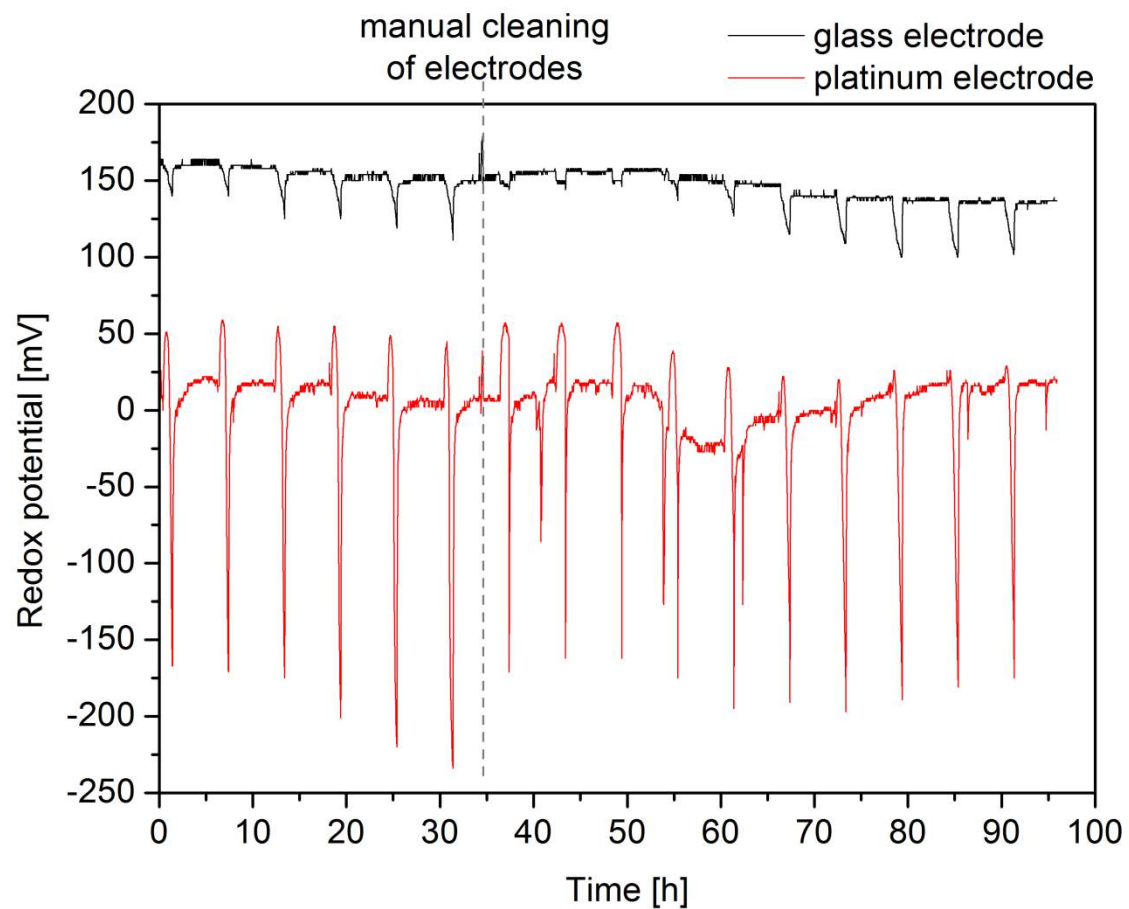

Use in practice

- Introduction
- New approach for redox potential measurement
- Fabrication of redox electrode glass and glass paste
incl. characterisation
- Fabrication of the electrodes
- Electrode test (laboratory)
- Field operation (Control of Process and Waste Waters)
- Outlook
- Conclusion
- Acknowledgement

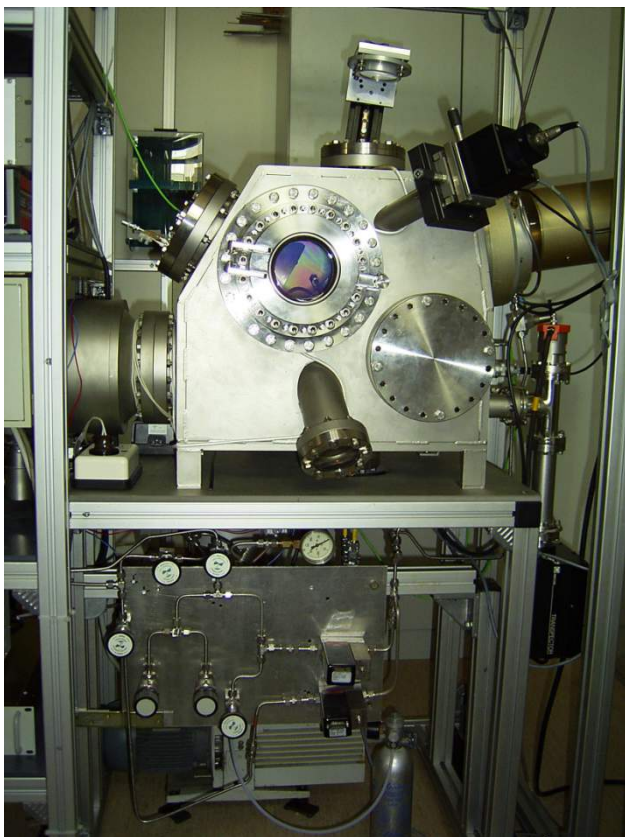

PLD equipment

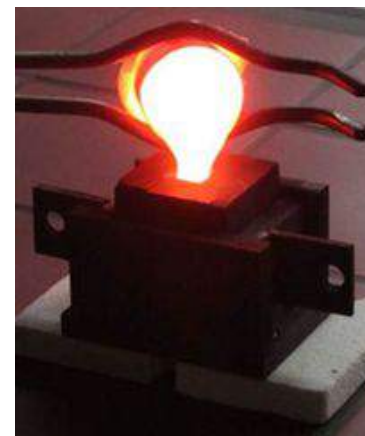
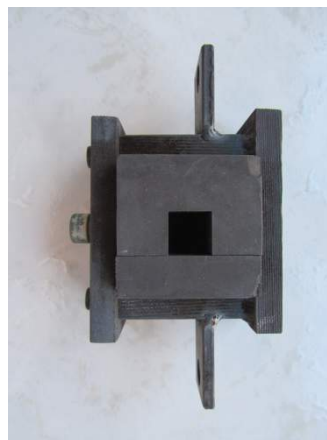

Casting mould target preparation

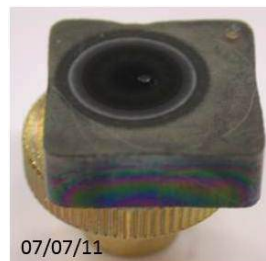

Redox glass target

W. Vonau, F. Gerlach, K. Ahlborn, M.J. Schöning, H. Iken: DE 10 2012 014 861

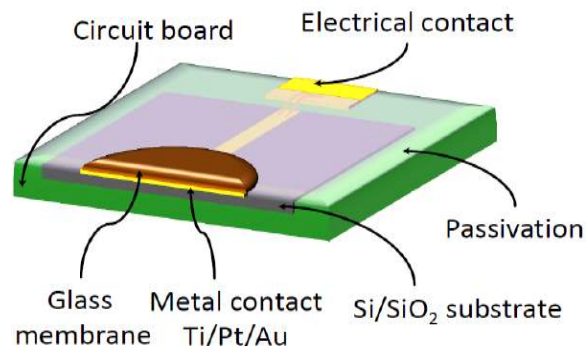

PLD based sensor



Comparison of electrode functions

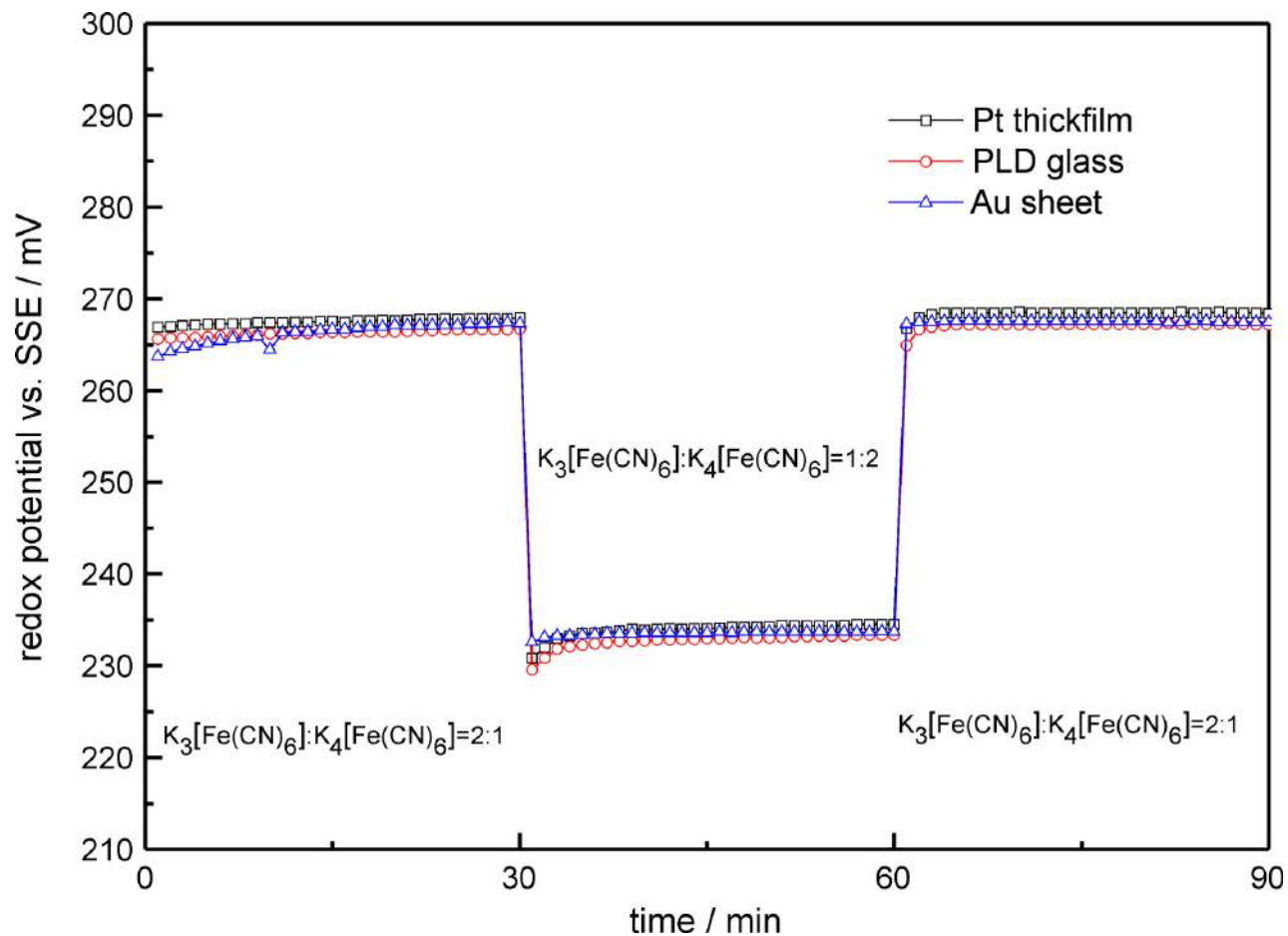

- Introduction
- New approach for redox potential measurement
- Fabrication of redox electrode glass and glass paste
incl. characterisation
- Fabrication of the electrodes
- Electrode test (laboratory)
- Field operation (Control of Process and Waste Waters)
- Outlook
- **Conclusion**
- Acknowledgement

Glass blower

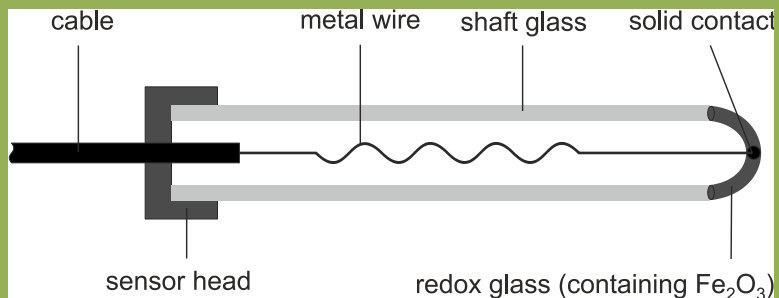

Thick film technology

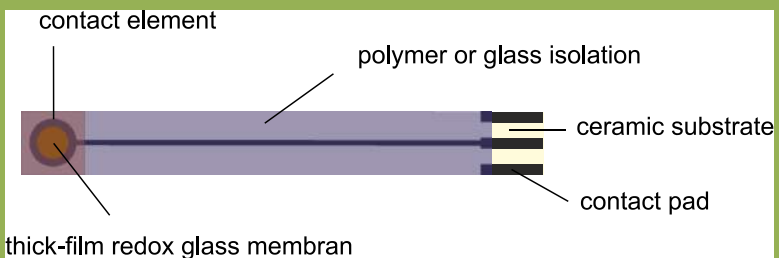

Laser ablation

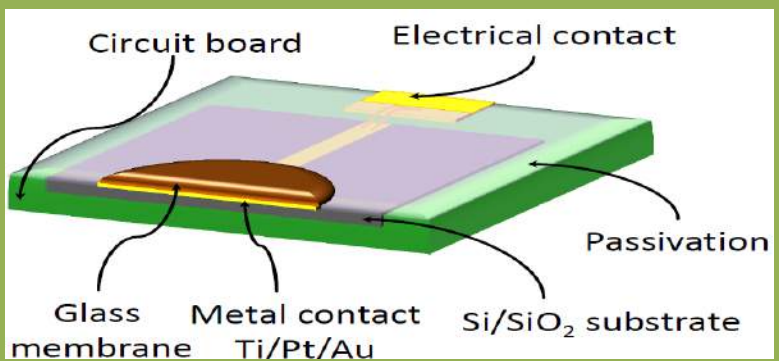

Layer thickness



- Introduction
- New approach for redox potential measurement
- Fabrication of redox electrode glass and glass paste
incl. characterisation
- Fabrication of the electrodes
- Electrode test (laboratory)
- Field operation (Control of Process and Waste Waters)
- Outlook
- Conclusion
- **Acknowledgement**

The financial supports of this work by the German Federal Ministry of Economics and Technology (BMWi) in the context of two AiF projects (grant numbers 16274 BR/1 and KF2218311RH1) are gratefully acknowledged.

Thank you for your attention.