

IBM Test Overview and Best Practices

Tara Astigarraga
asti@us.ibm.com
IBM STG, November 2012

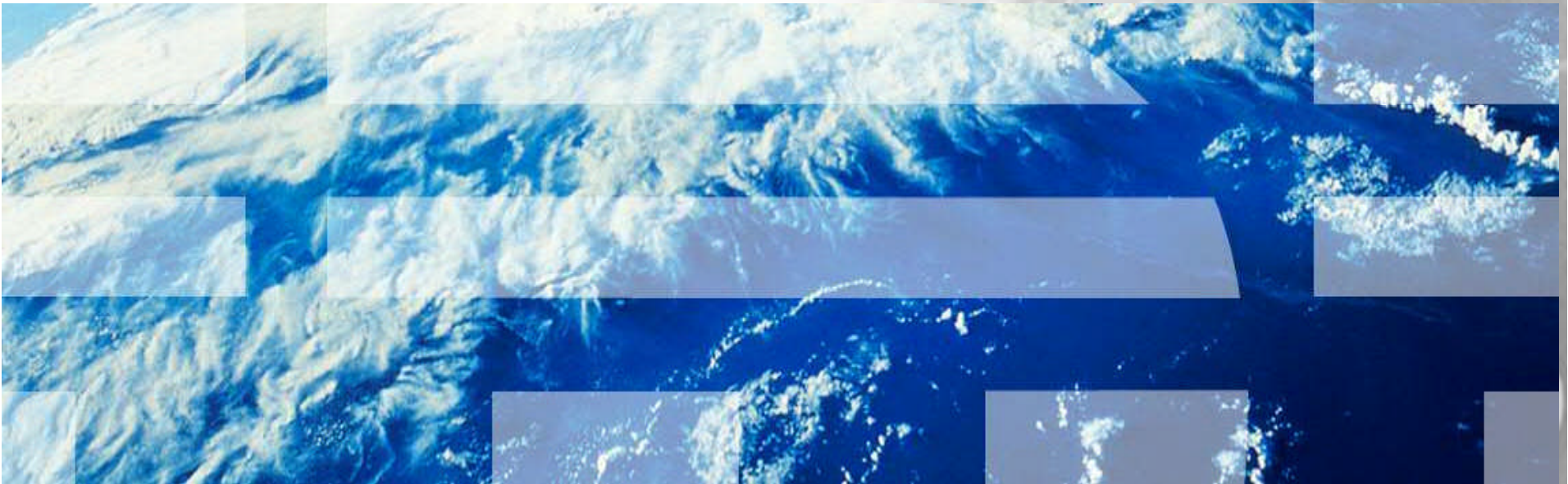

Permission is granted to IARIA to publish this presentation; IBM retains the right to distribute copies of this presentation material to whomever it chooses.

Agenda

- **Introduction to IBM Test**
- **Phases of Test**
- **Products Tested**
- **Test Strategy**
- **Complex Systems Test**
- **Characteristics of a Systems Thinker**
- **Keeping Pace with Technology**
- **Debug Methodologies**
- **Technical Communities**
- **Academic Initiatives**

○ Introduction to IBM Test

■ Test Structure:

- ▶ Thousands of test engineers world-wide
- ▶ An entire VP Organization dedicated to systems test
- ▶ Function test teams for every product stream
- ▶ Interop and Complex test labs world-wide
- ▶ Vendor test relationships across platforms
- ▶ Career Path in Test

Server & Storage System Test Sites

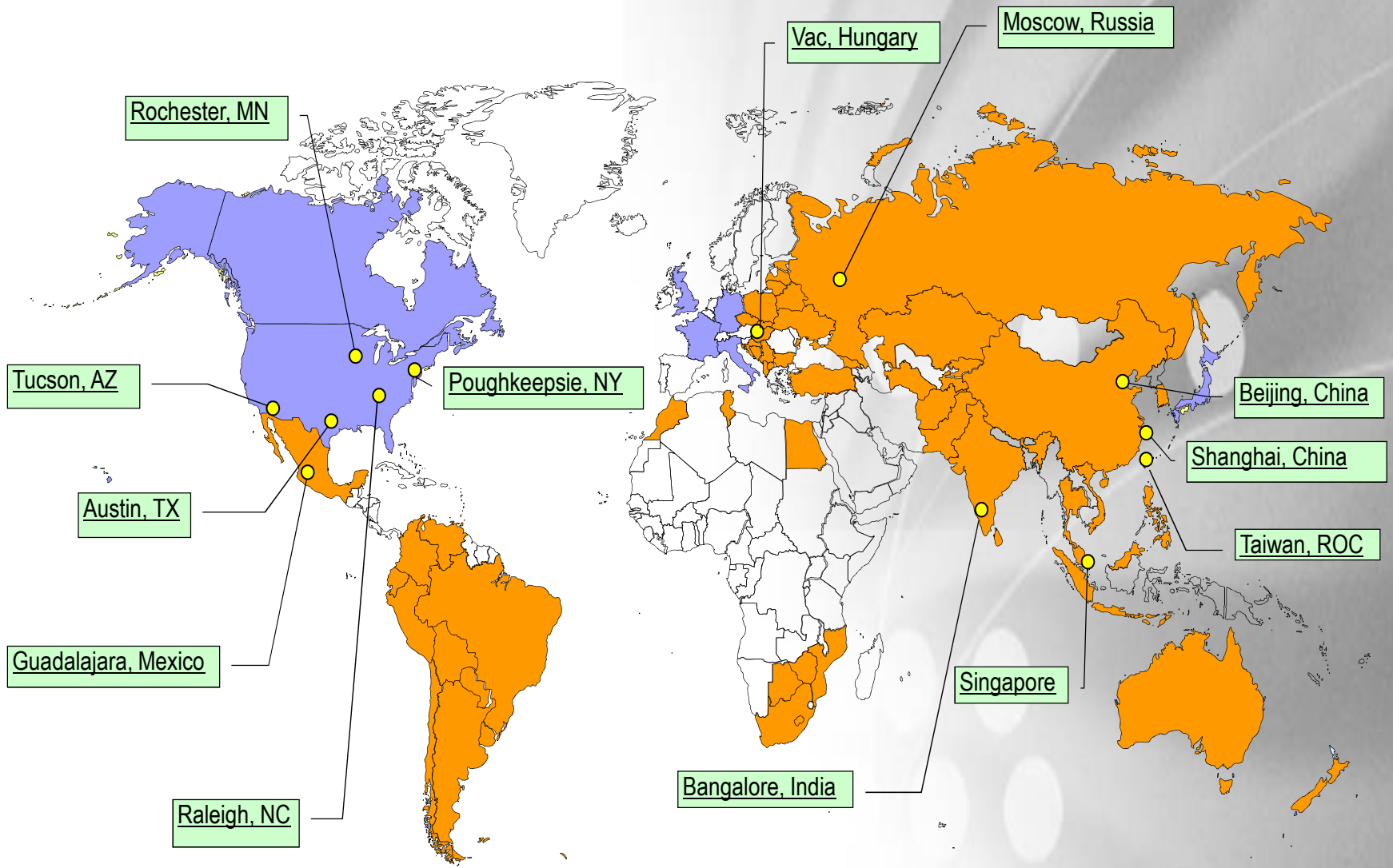

Test Initiatives

- **Finding the defects that matter**
 - ▶ Capture defects that would be reported to IBM Service
 - ▶ Increase discovery of high-impact defects
 - ▶ Analyze defects our customers report
 - ▶ Understand customer usage patterns
- **Quality**
 - ▶ Trust, but verify
 - ▶ Test case reviews
 - Remove stale test cases to make room for new ones
- **Innovation**
 - ▶ Test Smarter
 - ▶ Encourage change and test transformation
 - ▶ Automate verification where possible
 - Put the Engineering back into “Test Engineer”

Learn from the Customer

- Field Data Analysis

- ▶ What are the biggest problem areas?
- ▶ What are the current problem trends in the field?
- ▶ What are the biggest customer pain points?
- ▶ How do customers do things differently?

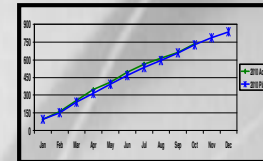

- Crit-Sits

- What kind of problem is the customer experiencing?
- How do problems impact the customers?
- How could this have been prevented?
- How can we help?

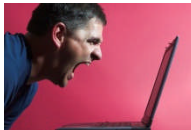

- Customer Engagements

- What are the current customer concerns?
- How do customers use our products?
- What do customers want and need in the future?

○ Phases of Test

- **Unit Test**
- **Function Test**
- **Integration Test**
- **Systems Test**
- **Performance and Scalability Test**
- **Hardware Function Test – System Level**
- **Hardware RAS and Compliance Testing**
- **Service and Regression Test**
- **Protocol Test**

Note: Tests are frequently grouped by where they are performed in the development cycle or by the area of specificity of the test. Above are a few examples heavily used within IBM, but this is not an all inclusive list.

Unit Test

- **Main goals and objectives of Unit Test – Program-level testing**
- **Best practices and processes for development-based unit testing**
- **Artifacts of Unit Test and the difference with other test phases**
- **Unit Test Coverage Models**

Where does this fit in testing continuum

- **Key skill required for engineers and computer scientist**
- **Critical foundation of the test phases**
- **Agile development helps enable more automated unit testing tasks**

Function Test

- **Verification and validation that product operates as expected and as designed**
- **Focus on strong rigor to follow practices and processes**
- **The importance of strong programming skills for Function Test**
- **Clear written and oral communication are critical**
- **Regression testing is a key to strong Function Testing**

Where does this fit in testing continuum

- **Key skill required for engineers and computer scientist**
- **Generally, function test is found to be the main testing phase that removes defects in the software lifecycle and this drives risk management situations**
 - ▶ **This risk management helps drive business decisions**

Integration Test

- **Focus on hardware & software product integration defects**
- **Critical test phase that directly precedes general availability of a product set or stack of products**
- **Team structure modeled after traditional corporate I/T roles**
- **Full migration and coexistence validation**
- **True product exploitation versus fundamental test programs**

Where does this fit in testing continuum

- **Collaboration and integration skills fit into integration test roles well (business, engineering, computer science)**
- **Builds strong cross-product diagnosis skills for industry**

System Test

- **System Test's role as the initial customer advocate**
- **System thinking, the 'BIG' picture and breaker mentality**
- **Importance of stability and regression testing to System Test**
- **Searching for constraints and ensuring resiliency & availability**
- **Importance of diagnosis and debug within test**

Where does this fit in testing continuum

- **Complex problem solvers fit into system test roles well (business, engineering, computer science)**
- **System programming skills developed in/for this phase**
- **Builds strong diagnosis skills for industry**

Performance and Scalability Test

- **Scientific Method Rules Here**
 - ▶ Finding Bottlenecks and Breakpoints, Differences in process from functional testing
 - ▶ Designing proper experiments, understanding what you are measuring
- **Discussion beyond just the computer**
 - ▶ Environmental cost analysis, code or hardware execution costs

Where does this fit in testing continuum

- **Good functional test engineers have reasonable performance testing skills**
- **Makes a well rounded test engineer**
- **Usually requires function and system test skills**

Hardware Functional Testing at a System Level

- Enterprise system complexity is a focus area
- Firmware complexity and redundancy
- Methods and attack vectors for testing complex hardware
- Circuit design verification is not covered
- Hardware System Integration flows
- Clustering, Virtualization and Security at a firmware level

Where does this fit in testing continuum

- Forces the entire system knowledge
- System programming focus
- Shows how to breakdown complexity
- Makes a well rounded test engineer

Hardware RAS and Compliance Testing

- **Reliability, Availability and Serviceability (RAS)**
 - ▶ Cornerstone of Enterprise Computing
 - ▶ Complex error injection, complex scenarios
- **Compliance Testing**
 - ▶ Ensuring the hardware meets all regulatory requirements
 - Underwriters Laboratories (UL) compliance, Federal Communications Commission (FCC), European Union (EU), Earthquake and safety testing
- **System Feature add and upgrade**
 - ▶ Focus on concurrent reconfiguration of hardware

Where does this fit in testing continuum

- Combines need for hardware and OS level knowledge
- Emphasis on service testing and usability
- Compliance has large impact on hardware design
- Hardware and Firmware internals are key

Service and Regression Testing

- **Service Testing**
 - ▶ **Key elements of the process of service testing and how it differs from release testing**
 - ▶ **Limitations and efficiency techniques**
- **Regression Testing**
 - ▶ **Why it is needed and how to select tests for regression**

Where does this fit in testing continuum

- **While these are small topics considerable discussion in the real world occurs for these**
- **Most new test engineers do this as their first job assignment.**

Protocol Testing

- **Open Standards Compliance Testing**
- **Low-level frame verification based on expected result**
- **Error recovery and function verified at frame level**
- **Protocol Interoperability between products**
 - **Different ways to interpret standards**
 - **Vendor unique/proprietary methods**

Where does this fit in testing continuum

- **Low-level protocol skills needed**
- **Need a solid understanding of standards, compliance and potential impacts for deviations**

Customer Migration Stack Testing

- **Customer/Migration Stack Testing**
 - ▶ **Exact modeling of hardware and software from ‘customer’**
 - ▶ **Hardware (computer, SAN, storage, network), firmware, operating system, middleware, application and high availability software**

Where does this fit in testing continuum

- **Part of Product Deployment Life Cycle**
- **Set of tests the consumer of a product has to do (vs. product producer)**

Product Test & Engineering Design

IBM Systems > IBM Systems-related services >

Product Testing & Engineering Design Services

Engineering solutions to meet your business needs

Product Testing & Engineering Design Services (PTEDS) is made up of a key IBM development organizations delivering leading-edge design/development, project management, test and analytical services in mechanical packaging, power subsystems, product cooling and design, test equipment and tool integration. These highly trained IBM teams of professionals, experienced in product development engineering, have qualified their state-of-the-art laboratories and personnel with the required product certification authorities in the United States, Europe, the Pacific Rim and emerging global markets. IBM is unique in having the talent and resources to be able to provide a wide range of comprehensive design services to you, our customer!



Product Testing & Engineering Design Services

- Overview
- Acoustics
- Electromagnetic Compatibility
- Environmental, installation planning and safety technology
- Equipment calibration
- Industrial design and human factors
- Integrated Tool Technology Center
- Interconnect
- Material selection and analysis
- Mechanical analysis and test
- Mechanical packaging and reliability engineering
- Project management
- System power
- Thermal/product cooling

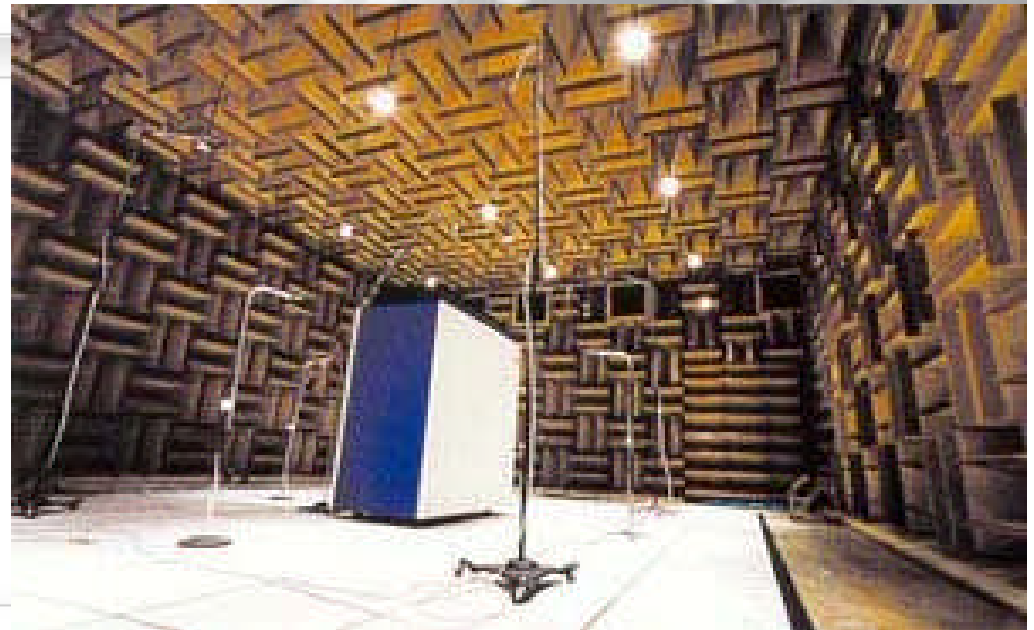

IBM Systems > IBM Systems-related services >

IBM Platform Test

Systems and Technology Group

IBM Platform Test

Customer-like, end-to-end integration testing of products, solutions, and service from IBM



Why IBM Systems Platform Test?

Our emphasis is on simulating the customer experience, including cross-product interoperability, orderly upgrades and migrations, high availability, systems management, and various other systems-related activities. We aim to simulate the workload volume and variety, transaction rates, and lock contention rates that exist in a typical customer shop, stressing many of the same areas of the system that our customers stress. Ultimately, we believe that only by acting like customers ourselves can we understand what our own customers actually experience when they use our products.

What we offer

From our extensive testing, we offer a variety of collateral for your use.

- Test Reports - useful experiential information resulting from our detailed testing
- Best Practices - suggestions to help you implement IBM technologies
- Samples - sample configuration files from our test environment
- Hints and Tips - the latest information so you don't have to wait for the next release of the test reports
- Related publications - additional documentation we have written (for example whitepapers).
- Links to our library - the product publications

IBM Platform Test - Servers

- IBM i
- System p
- System z

Locations

- Poughkeepsie, NY, USA
- Rochester, MN, USA

<http://www-03.ibm.com/systems/services/platformtest/>

Approach for End to End (E2E) Customer Test (Custom Test Labs)

OPERATIONS ENGINEERING & MAINTENANCE

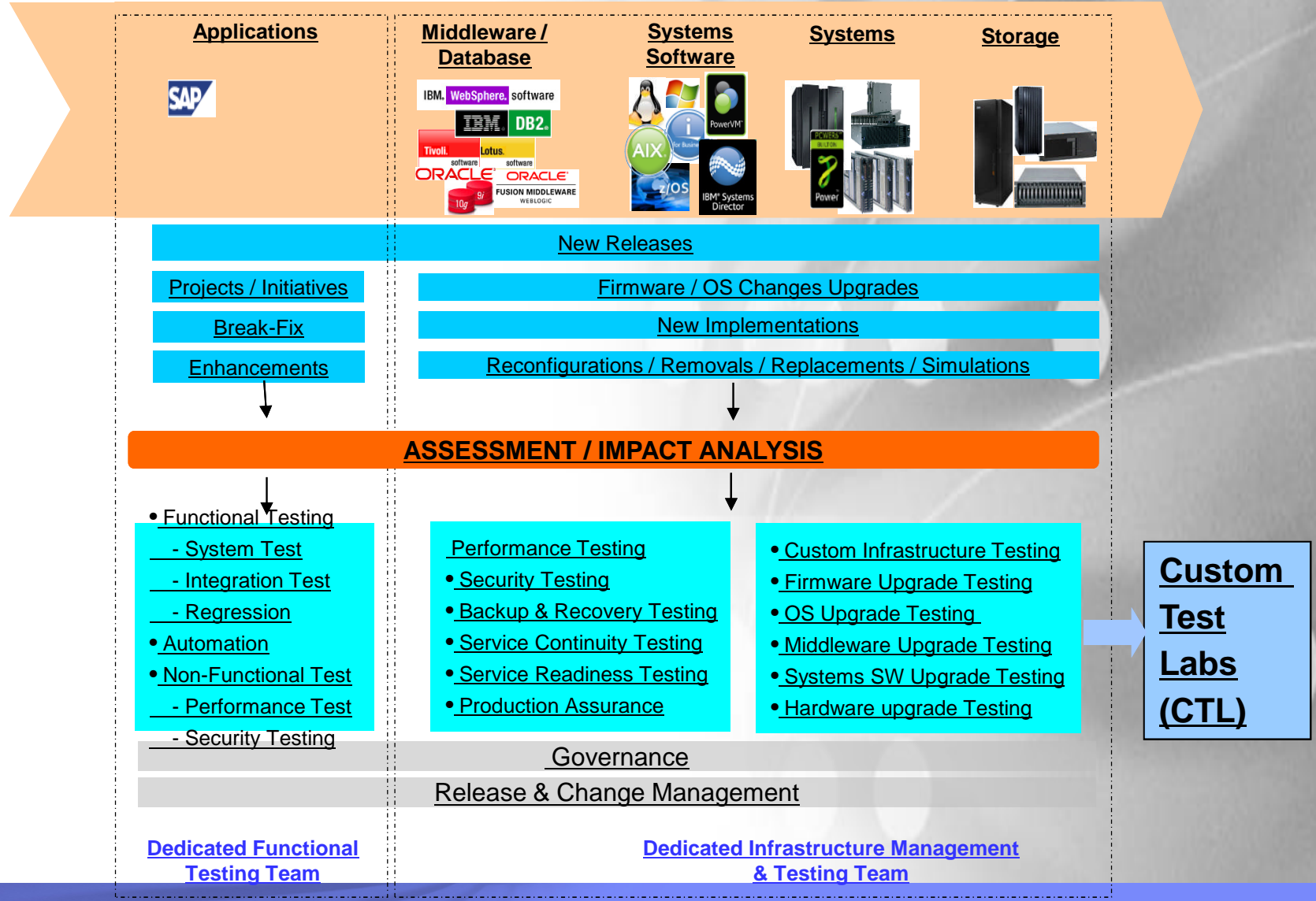

What Drives the Majority of Client Problems?

Complicated Product Stacks (both HW & SW)



Applications

x

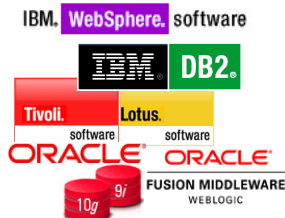

Middleware /
Database

x



Systems
Software

x



Systems

x



Storage

Complex System and Application Configurations

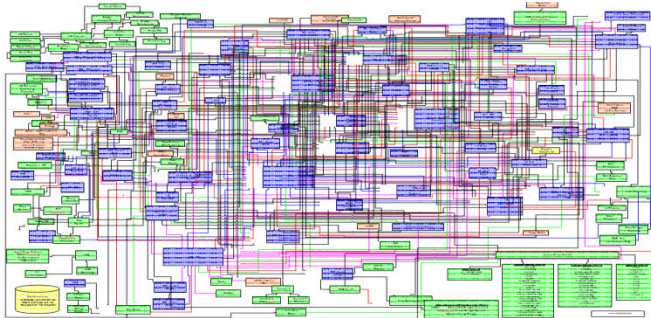

- Difficult to explain configuration
- Difficult to isolation problem
- Difficult to diagnose root cause
- A time consuming and confusion-ridden process

Difficult Maintenance & Upgrade Scenarios (both HW & SW)

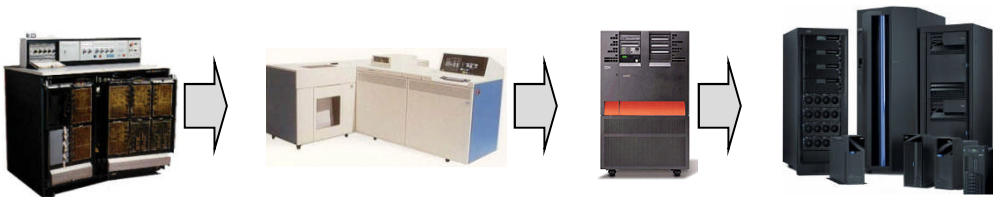

- Which version is supported?
- How should we plan for an upgrade?
- Will this configuration work?

○ Products Tested

- Servers
- Blade Servers
- Host Adapters
- Disk Storage
- Tape Storage
- Information Management Software
- Service, Integration and Collaboration Software
- Operating Systems
- Storage Area Networks
- Network Attached Storage
- And more...

Software		Systems	Storage
▪ Product finder	▪ Lotus (collaboration)	▪ PureSystems	▪ Disk systems
▪ Downloads	▪ Rational (software and systems delivery)	▪ Power Systems (AIX, IBM i, Linux)	▪ Tape systems
▪ Business analytics (Cognos, SPSS)	▪ Tivoli (service management)	▪ System z (Mainframe)	▪ Storage area networks
▪ Enterprise content management	▪ WebSphere (integration and optimization)	▪ System x (xSeries)	▪ Network attached storage
▪ Information management (DB2, Informix, InfoSphere)	▪ System z software	▪ Blade servers	
		▪ UNIX servers	
		▪ Systems software	

IBM System Storage Interoperability Center (SSIC)

Currently publishes 344million+ configurations supported by IBM

IBM System Storage Interoperation Center (SSIC)

- Start your search with ANY of the below selection boxes. You are NOT required to perform your query from the top down.
 - Please view the details of your selected configuration. This requires clicking the Submit button or exporting your data.
- NOTE:** New search feature introduced in SSIC, please click [here](#) for details.

[New Search](#)
Configuration Results= 344238624
[SSIC Education and Help](#)

Storage Family <ul style="list-style-type: none"> IBM Network Attached Storage IBM System Storage Dual Drive Enclosures IBM System Storage Enterprise Disk IBM System Storage Enterprise Tape IBM System Storage Entry Disk 	Storage Model <ul style="list-style-type: none"> 3494 with 3590 Drives 3494 with 3592-J1A Drives 3494 with TS1120 (3592-E05) Drives 3494 with TS1130 (3592-E06) Drives 3580 with Ultrium 1 Drives
Storage Version <ul style="list-style-type: none"> 3494 (536.22) with 3590 Drives (D0IF_2D4) 3494 (536.22) with 3592-J1A Drives (D3I0_C90) 3494 (536.22) with TS1120 (3592-E05) Drives (D3I1_E8B) 3494 (536.22) with TS1120 (3592-E05) Drives (D3I1_EA8) 3494 (536.22) with TS1120 (3592-E05) Drives (D3I1_EC7) <p>Export Selected Storage Version (xls)</p>	Connection Protocol <ul style="list-style-type: none"> CIFS CIFS (SMB2 Data ONTAP only) ESCON FCoCEE FCP
Host Platform <ul style="list-style-type: none"> IBM Flex Systems IBM System z IBM BladeCenter IBM Power Systems (p6 and newer) IBM System i 	Server Model <ul style="list-style-type: none"> ALL x86 & x86_64 Compatible Servers Apple Mac G4 Apple Mac G5 Apple Mac Pro Apple Mac Servers
Operating System <ul style="list-style-type: none"> Apple Mac OS X 10.3 Apple Mac OS X 10.4 Apple Mac OS X 10.4.10 Apple Mac OS X 10.5 Apple Mac OS X 10.5.2 	Adapter (HBA, CNA, etc) <ul style="list-style-type: none"> ATTO 3300 ATTO 3321 ATTO Celerity FC-41ES ATTO Celerity FC-42ES ATTO Celerity FC-44ES
Switch Module <ul style="list-style-type: none"> IBM 10Gb Ethernet Pass-Thru Module (P/N 46M6181) IBM BladeCenter Ethernet I/O Module (Switch or Pass-Thru) IBM BladeCenter Optical Pass-thru Module (P/N 02R9080) IBM BladeCenter S SAS RAID Controller (P/N 43W3584) IBM BladeCenter SAN Switch Module (P/N 48P7062) 	SAN or Networking <ul style="list-style-type: none"> ANY Direct Attachment ANY Ethernet Switch ANY Fibre Channel Switch BNT G8246 Brocade 200E
Clustering <ul style="list-style-type: none"> <none> Fujitsu PRIMECLUSTER 4.3 Fujitsu PrimeCluster 4.1.4 Hewlett Packard ASE 1.6 Hewlett Packard Clustering Supported 	Multipathing <ul style="list-style-type: none"> <none> ATTO Multipath Director Apple Atto Multipath Driver 1.30b Apple Atto Multipath Driver 1.31MP Apple MPT (Native OS)
Storage Controller <ul style="list-style-type: none"> Bull Storeway 1500 Bull Storeway 2000 Bull Storeway 3000 Bull Storeway FDA1500 Bull Storeway FDA2500 	Intercluster SAN Router <ul style="list-style-type: none"> Brocade 48000 FR4-18i blade Brocade 7500 Brocade 7500E Brocade 7800 Brocade DCX FR4-18i Router Blade

[New Search](#)
Configuration Results = 344238624
Submit

IBM Product Offerings Overview

Storage

- Disk
- Network attached storage
- Storage area networks
- Storage software
- Tape
- Storage "A-Z"
- Certified used storage

Networking

- Switches
- Transceivers and cables
- Networking software

Products especially for

- Medium businesses
- Small businesses
- Business Partners

Retail store products

- Point-of-sale
- Self-service
- All retail store products

Personal Computers

- Used from IBM
- PC recycling and buyback programs for businesses

Printing Products

- Printing systems and supplies from InfoPrint Solutions Company*
- Printing paper and toner from IBM

Software

- Product finder
- Systems software

Popular software product lines

- CICS
- Cognos
- DB2
- FileNet
- IMS
- Informix
- InfoSphere
- Lotus
- Platform Computing
- Rational
- SPSS
- System z
- Tivoli
- WebSphere

And Now For The Parts

- **Storage Controller/Controller**
 - ▶ The control logic in a storage subsystem that performs, among other things, command transformation and routing, I/O prioritization, error recovery and performance optimization
- **Fabric**
 - ▶ Interconnection method that allows multiple hosts and/or storage devices connected with a multi-port hub, simultaneous and concurrent data transfers
- **Adapter**
 - ▶ Circuit board that provides I/O processing and physical connectivity between a server and storage device
- **Multipathing**
 - ▶ The use of redundant storage networking components (adapters, cables, switches) responsible for the transfer of data between the server and the storage

Definition sources : [Google](#), [wikipedia](#)

What Drives the Majority of Client Problems?

Complicated Product Stacks (both HW & SW)



Applications

x

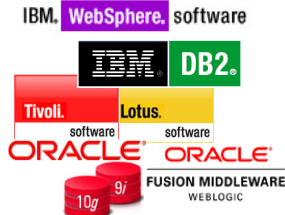

Middleware /
Database

x



Systems
Software

x



Systems

x



Storage

Complex System and Application Configurations

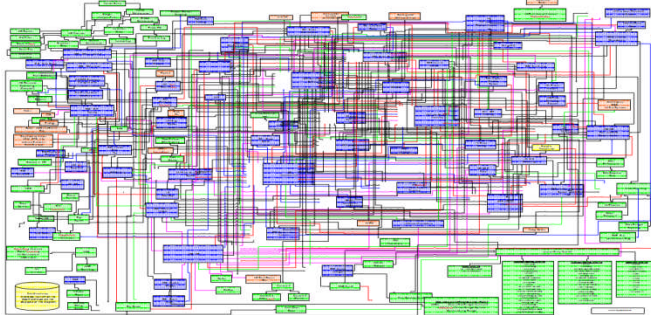

- Difficult to explain configuration
- Difficult to isolation problem
- Difficult to diagnose root cause
- A time consuming and confusion-ridden process

Difficult Maintenance & Upgrade Scenarios (both HW & SW)

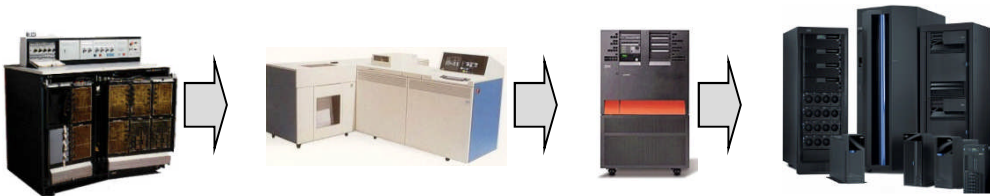

- Which version is supported?
- How should we plan for an upgrade?
- Will this configuration work?

Strategy & Configuration Management

The Challenge:

- We have too many combinations to deal with
- We would like to use our time efficiently
- We would like to control the risks we are taking
- We would like to know what we tested
- Minimize omissions

A Solution: Combinatorial Test Design (CTD):

- Systematic planning of tests
- Maximizes the value of each tested scenario
- Significant reduction in the number of tests
- Controlled risk
- Easy to review
- Minimizes omissions

▶ CTD – Combinatorial Test Design

- **All-pairs testing or Pairwise testing: method that, for each pair of input parameters to a system, tests all possible discrete combinations of those parameters.** Using carefully chosen test variations, this can be done much faster than an exhaustive search of all combinations of all parameters, by "parallelizing" the tests of parameter pairs.
- ▶ **IBM Research FoCuS Tool designed to model coverage and test plan design**
 - **The CTD concept can easily be extended from covering all pairs to covering any t -wise combinations**

Combinatorial Test Details

- How it works

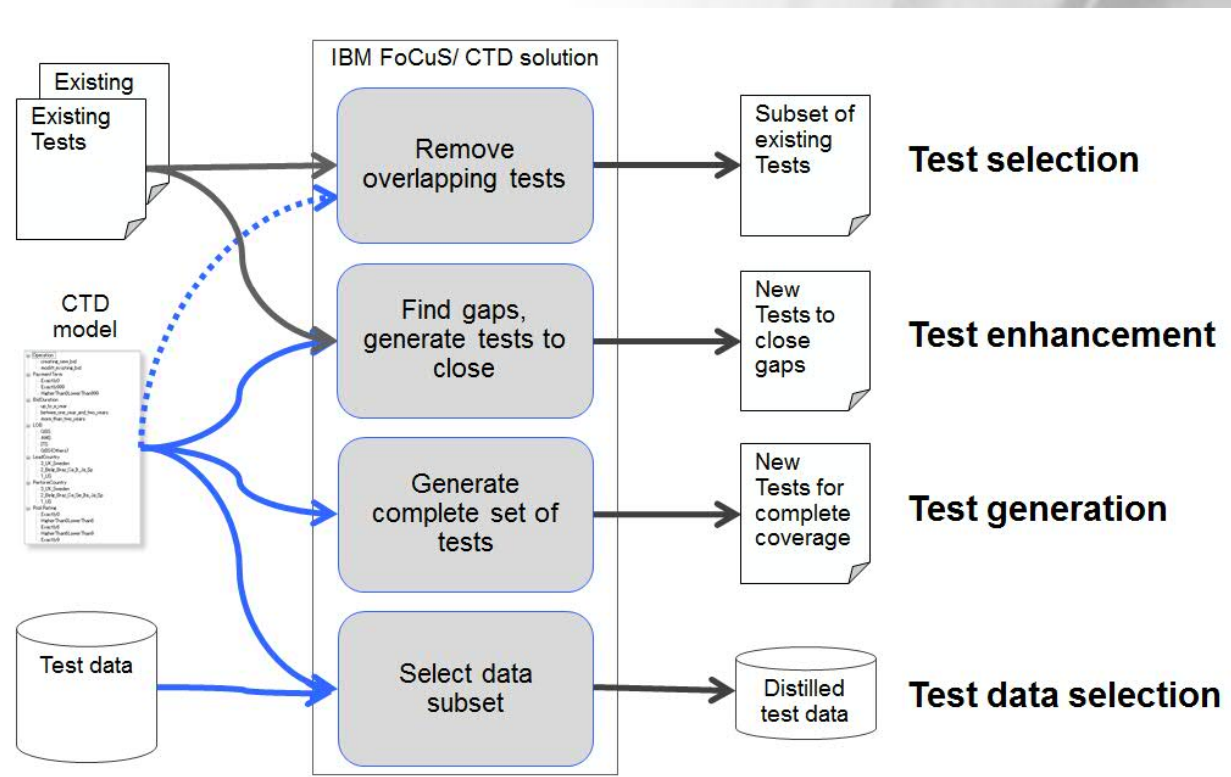

For more information on the IBM Research FoCuS/CTD Solution:
http://www.research.ibm.com/haifa/dept/svt/papers/CTD_Introduction.pdf

Benefits of Combinatorial Test

- Reduces the problem space dramatically
- Allows more time for deeper systems level test and exception or error inject scenarios instead of just covering the variations.
- Fewer test gaps and more support claims
- Capability to spread testing across teams
- Adds testing for 'unexpected combinations'
- Test Plans backed by IBM Research (FoCuS Tool)
 - Reflects years of study in advanced combinatorics
 - Explicitly identifies what is tested and what is not tested
 - Test plans are easier to create, review and testing is well documented
 - Proven method and coverage algorithms
- Most defects can be discovered in tests of the interactions between the values of two variables (65-97%)
 - *Source: <http://csrc.nist.gov/groups/SNS/acts/ftfi.html>*

○ Complex Systems Test

- **Test Engineer vs. Test Executor**
 - ▶ Must have ability to *debug complex* hardware/software interactions
- **Testers Choice Test Cases**
 - ▶ Allow experienced testers freedom to explore areas that seem promising based on 'hunches' initial test results or other objective criteria
 - ▶ Many of the high impacts bugs we find in our environments came from a Test Engineer following a hunch vs. an explicit test case

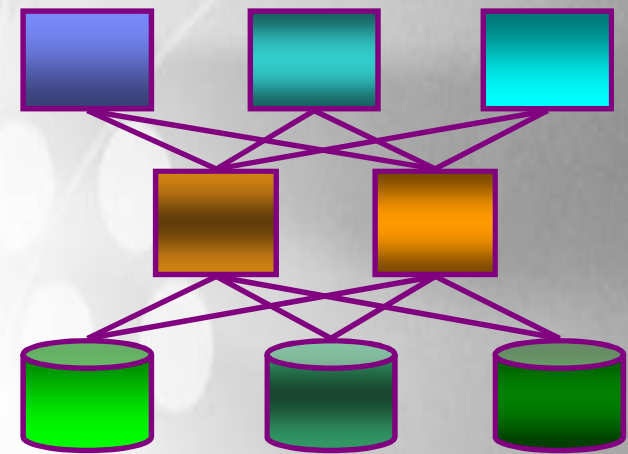

Complex Systems Testing - Known Knowns

- **“There are known knowns. These are things we know that we know. There are known unknowns. That is to say, there are things that we know we don't know. But there are also unknown unknowns. There are things we don't know we don't know.”**
 - ▶ **Donald Rumsfeld, February 12th, 2004 DOD News Briefing**
- **Good summary of what complex testing involves!**

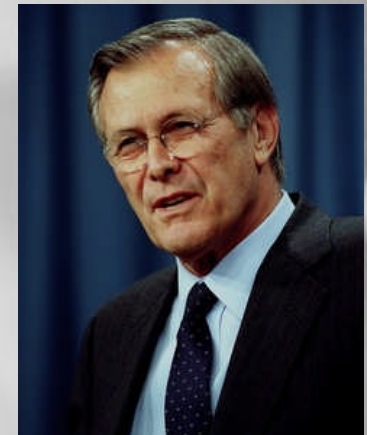

- **Systems Thinking:
Desired Characteristics of a Systems Test Engineer**
 - **What is Systems Thinking?**
 - **What are the benefits of Systems Thinking?**
 - **What are the types of skills, knowledge and characteristics of a Systems Thinker?**
 - **How does Systems Thinking play a role in strategy?**

What is Systems Thinking?

To understand the concept of *Systems Thinking*, it is important to understand what the term "System" refers to. Actually, Webster's definition of system holds quite well. It reads, an assemblage of objects united by some form of regular interaction or interdependence. The level of system that is being addressed here is that assemblage of objects that have client recognizable value, or in other words ... have stand-alone market value. Systems that have standalone market value have value that can be characterized in terms of their function, performance, cost, usability and quality. Every component that goes into that system makes a contribution to those pervasive market values that clients ultimately realize and assess to their expectations.

Each and every one of you makes a contribution to that end product (system) market value.

Systems Thinking is critical in our business because it's about delivering the ultimate in market value and client value whether it be products or services.

What are the benefits of Systems Thinking?

▼ 1. Creative problem solving and prevention

To effectively solve problems in organizations, it is critical to be able to identify the real causes of problems and how to address them. Without clear understanding of the *big picture* of an organization, we tend to focus on only the behaviors and events associated with problems in the workplace, rather than on the systems and structures that caused the problems to occur in the first place.

▼ 2. Improved communications

One of the most important ingredients for the success of any system, including organizations, is ongoing communications among all the parts of the organization. Without a clear understanding of the parts of an organization and how they relate to each other, it is difficult to know what to communicate and to whom.

▼ 3. Enhanced business planning

The planning process is basically working one's way backward through the system of an organization, including identifying desired results (goals and outcomes), what outputs (tangible results) will indicate that those results have been achieved, what processes will produce those outputs, and what inputs are required to conduct those processes in the system.

▼ 4. More effective organizational development

The most effective form of organizational development results from use-focused strategies, including strategic planning, management and leadership development, team building and principles of organizational change. Having a systems view is critical to accomplishing effective organizational development.

These organizational advantages will directly drive personal and professional benefits! Benefits include things like improved product quality; reduced cost structures; increased competitiveness, market share and profitability; targeted client solutions; and, greater professional growth and learning.

Not everyone will want to become a Systems Thinker, nor will they be required to be one. However, each one of us can understand and incorporate Systems Thinking into our day-to-day activities. A major focus of our strategic plan is to *think in the client's shoes* allowing IBM to increase our overall ability to provide On Demand solutions to our clients.

What are the types of skills, knowledge and characteristics of a Systems Thinker?

- ▼ Use this information as a guide as to what qualities a Systems Thinker possesses.

This section contains the following topics:

- [Skills and knowledge](#)
- [Characteristics and profile](#)
- [Stretch Zones](#)
- [T-shaped Systems Thinking model](#)

Skills and knowledge

Although Systems Thinkers have used formal education resources over the years, they have also complemented their learning through on-job-training (OJT), mentoring, coaching, job rotations and direct client interactions. The following table lists the types of skills and knowledge a System Thinker needs to view a system.

Skills	Knowledge
<ul style="list-style-type: none"> • Research and fact-finding • Listening skills • Communication skills • Questioning skills • Relationship building • Negotiations • Networking • Managing customer satisfaction and issues • Interpersonal skills • Teaming and orchestration • Problem solving • Analysis and synthesis • Leadership • Logical deduction • Problem prevention 	<ul style="list-style-type: none"> • IBM strategy • IBM products, services and positioning • Processes • Resources and knowledge management • Customer's business and industry • General business operations • Financial acumen • Deep technical knowledge in one area; broad knowledge in relevant areas (T-shaped) • Prioritizing problems based on business need • Competition

Attributes of a System Thinker

- can come from a wide variety of backgrounds, interests and education
- love to learn new things
- never say no
- the tougher the problem, the greater their interest is in solving it.
- are not afraid of failing
- believe that failures are not failures, but simply that they have not yet uncovered the solution

Characteristics and profile

General agreement about the ideal characteristics and profile of a Systems Thinker

Characteristics and profile	
<ul style="list-style-type: none"> • Adaptable • Decisive • Takes risk • Optimistic • Curious • Negotiator • Positive • Committed • Influential • Responsive • Drive and persistence • Customer savvy • Excellent communicator • Resolves issues • Is IBM's conscience 	<ul style="list-style-type: none"> • Thinks from the outside in • Naturally inquisitive • Loves to learn • Ability to extrapolate from experiences • Focused on problem prevention • Often steps outside comfort zone • Sees the big picture • Not afraid to fail • Does in-depth research • A self-starter • Strong networker • Learns from mistakes • Strong team player

Stretch zones

We need to operate out of our comfort zone to further our skills, understanding and capabilities. Simply stated, if we are not stretching, we are shrinking ... get out of your comfort zone and challenge yourself. The stretch zone is not always a comfortable place, but it is a stimulating one. The following example explains the different stretch zones.



The following tips can help expand your stretch and comfort zones. For other references, see the links located in the Master the Basics, Study in Depth and Advanced tabs.

- Read IBM Redbooks™
- Engage technical mentors
- Take on assignments that force stretching
- Create multiple-use intellectual property
- Publish papers from a systems viewpoint
- Join technical communities in and outside IBM
- Read technical journals
- Don't shy away from unfamiliar technology
- If you want to learn something...explain it to others
- Understand and share technical conference resources

T-shaped Systems Thinking model

A Systems Thinker generally is also a 'T-shaped' person combines depth in certain areas of expertise with broad experience. The following diagram is an example relevant to the Test Organization.

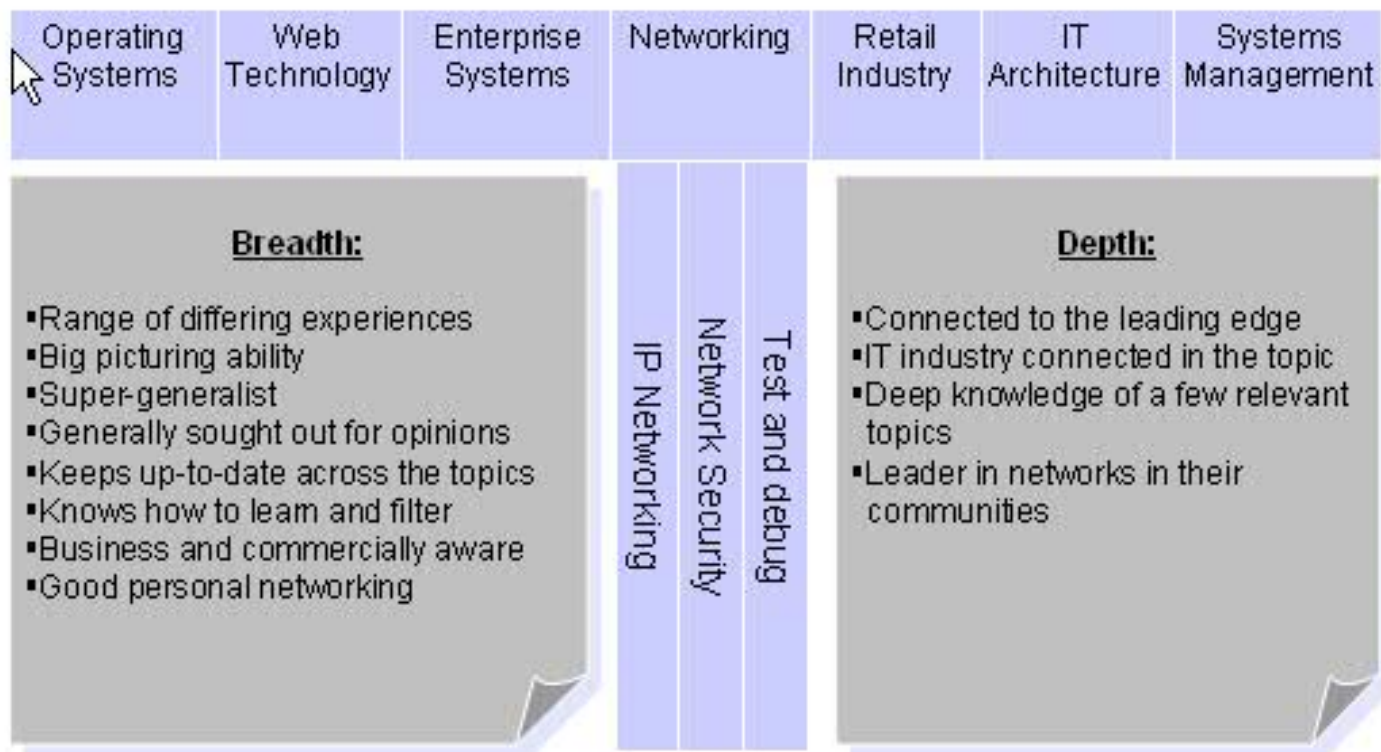

Keeping Pace with Technology

- **Systems test engineers must have a broader set of skills than they've needed in the past**
- **If you don't understand it, you can't program it.**
 - ▶ **If you don't understand it, you can't test it**
- **The significant problems we face cannot be solved by the same level of thinking that created them. -- Albert Einstein**

○ Debug Methodologies

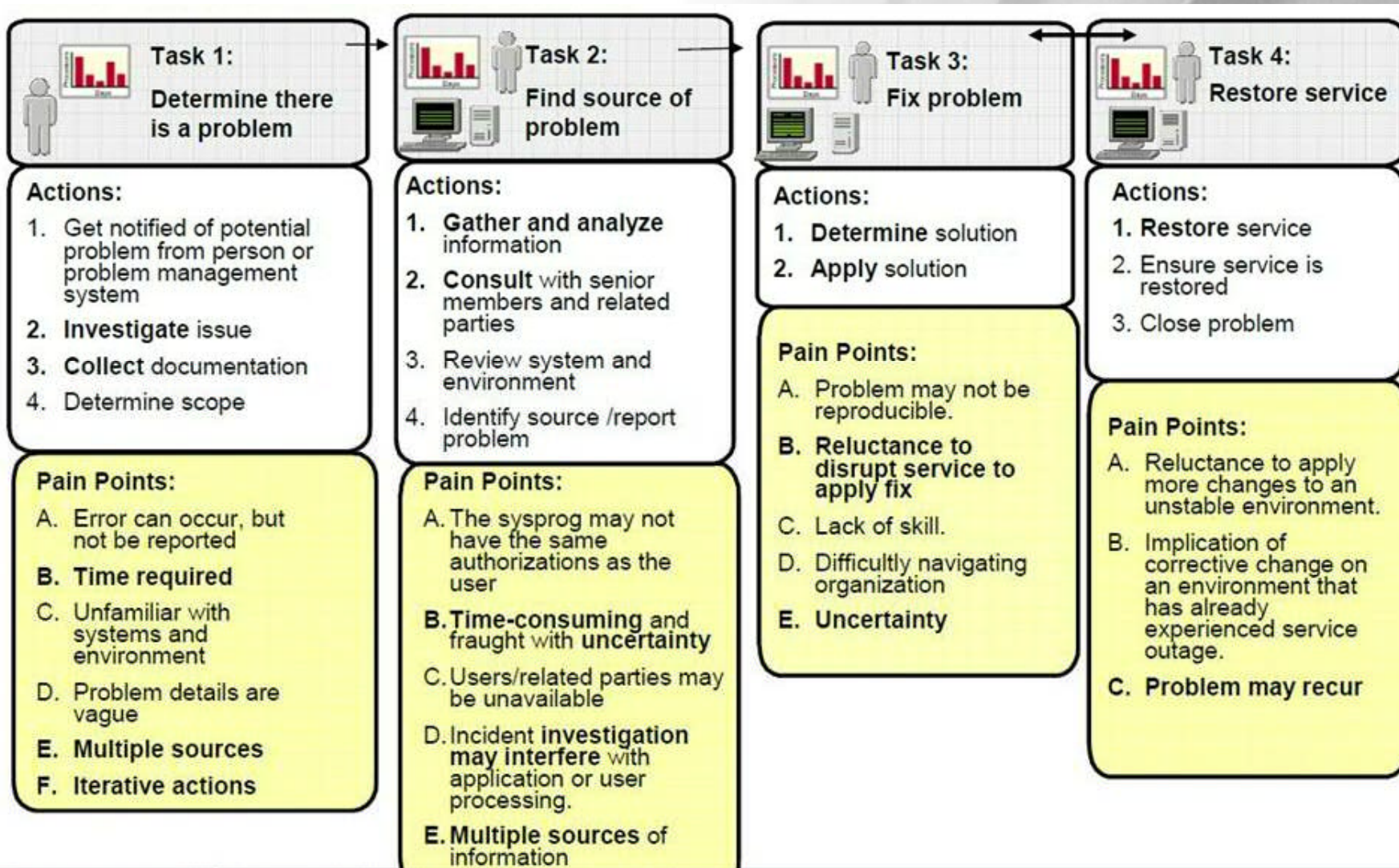

Troubleshooting Methodology

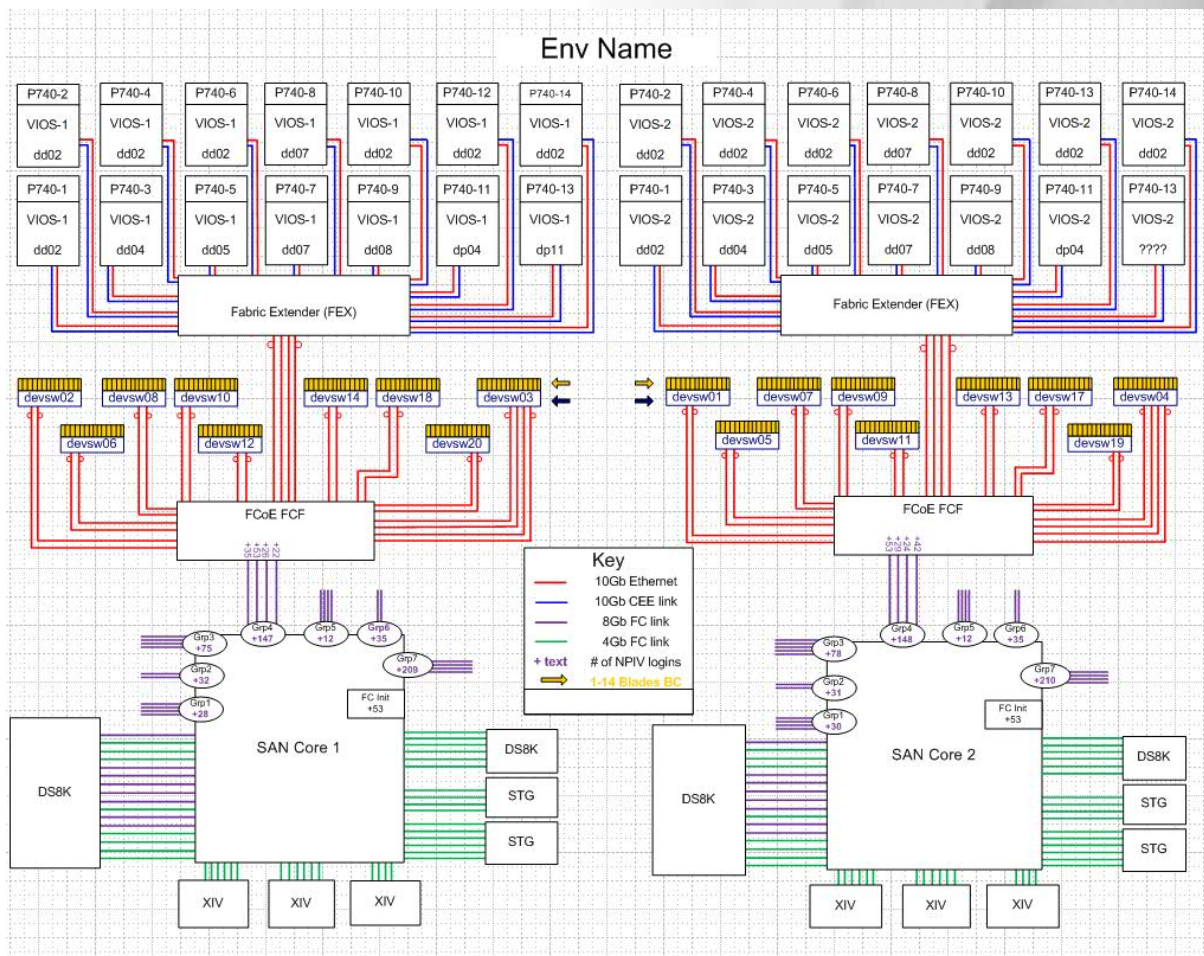

Documentation plays a key role in understanding and troubleshooting many environmental network issues. Especially in a mixed vendor and mixed protocol environment, network issues can quickly impact or degrade performance. Therefore, it is important to understand your environment and to have a systematic approach to troubleshooting problems including a detailed mapping of all data flows.

Troubleshooting Basics - Before

- Systematic troubleshooting documentation and flow diagrams help to answer basic troubleshooting questions and provide data on end-to-end flow structures.
- A valid network flow diagram will help to ensure the teams assisting in debug can quickly understand the symptoms, accurately decipher the problems and accordingly search for root cause.
- Knowing port numbers, typical data rates, data flows and operational modes of the hardware/software components in the environment is essential in order to focus on the right components for a given problem.

Troubleshooting Basics - During

Once the environment is understood, begin to ask probing questions to identify a list of symptoms, changes and potential problem points.

- When did the problem start?
- Have any changes been made to the environment?
 - Hardware, software, firmware, configuration..
- Identify list of symptoms by component
 - Which hosts, storage, switches..
- Verify physical port config and data flow across components identified above
- What log errors are being reported for each component
- Ensure time stamps are accurate across components to aid in debug
 - Consider deeper logging levels is required for debug
- Monitor port information (counters, statistics, events and errors)
- Check network tools and advanced problem detection and monitoring software

Troubleshooting Basics - During

Understand what level of debug is needed.

Often times lower level protocol errors present themselves at the application or host level, even though the true root cause of the issue resides at a much lower level in the stack.

Most issues in complex network environments typically occur at the first few layers (Physical layer, Data Link Layer and Network Layer).

It is crucial before delving into complex high-layer troubleshooting that the fabric is first checked for any lower layer activity that is not characteristic of previous trends.

Troubleshooting – By Issue Type

Connectivity Issues:

- Check that the port is Online with proper port type and wwpn.
 - If offline, debug
 - If online, check link status
 - Look for port going up and down (online/offline)
 - Look for loss of signal or loss of sync events

Troubleshooting – By Issue Type

I/O Errors on Data Path or Command Timeouts:

- Check for a bad SFP, cable or connection in I/O path. Check flow diagram for ports in data path.
 - ▶ Check associated ports for errors in counters
 - ▶ Look for any suspicious port errors
 - ▶ Look for low buffer credit numbers or high pause times
 - ▶ Clear counters and look for new errors
- Typical suspicious port errors include: CRC errors, bad eof, link fail, loss sync, loss signal, class 3 timeouts, discards, input errors and output errors.
- A small number of errors of this type at high traffic areas in the environment can have large impacts on many up-stream devices

Troubleshooting Soft Failures

Soft Failures: What is a soft failure?

“Sick, but not dead” or Soft failures

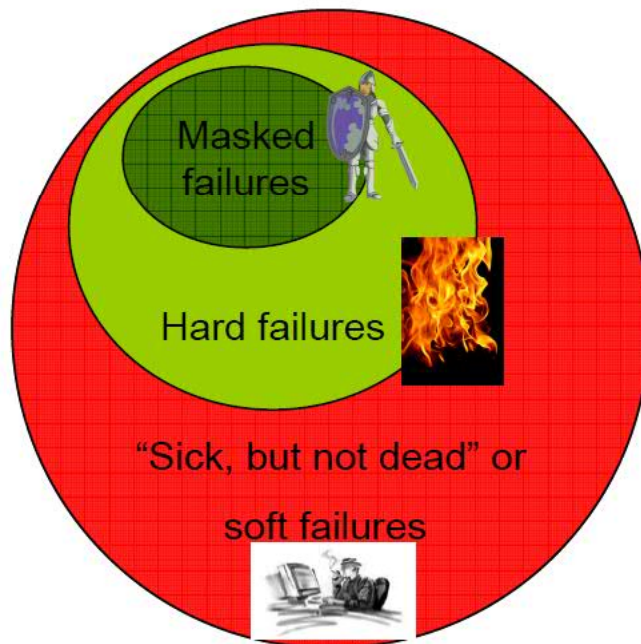

- 80% of business impact, but only about 20% of the problems
- Long duration
- Infrequent
- Unique
- Any area of software or hardware
- Cause creeping failures
- Hard to determine how to isolate, diagnose
- Hard to determine how to recover
- Hard for software to detect internally
- Probabilistic, not deterministic

Issue Reported:

- Performance is bad. Major performance impacts and HA failover events seen by clients.

SAN Switch Logs Show:

ISL Discards		
chbs132f01v0d11:88 (ISL):chbs132b01v0b12:205 (ISL)	135	
chbs132f01v0d11:40 (ISL):chbs132b01v0b12:13 (ISL)	33	
chbs132b01v0b12:13 (ISL):chbs132f01v0d11:40 (ISL)	14	
chbs132f01v0d11:432 (ISL):chbs132f01v0d12:416 (ISL)	10	
chbs132b01v0b12:205 (ISL):chbs132f01v0d11:88 (ISL)	9	
chbs132f01v0d11:416 (ISL):chbs132f01v0d12:432 (ISL)	6	

ISL CRC Errors		
208200051ed09400:208200051ed09600	8,864	

What are Common Causes of CRC (Cyclic Redundancy Check) Errors?

- CRC Errors are usually caused by physical problems with the optics
- Faulty, dirty or mismatched cables,
- Failing or dirty SFP transceivers
- Failing or dirty patch panels
- Poor cable management, exceeding minimum bend radius, kinked cables, etc.

What are Common Causes of Class 3 Discards?

*A Discard occurs when the switch receives a frame and is unable to pass it along to the next point on the path to its destination.

- The outbound link is being reset
- Zoning restrictions
- The destination no longer exists
- The switch does not have sufficient buffer-to-buffer credits (as with an overloaded target or congested ISL).

If Class 3 Discards are being observed due to credit issues, there will be serious performance issues in the SAN fabric.

○ IBM Test Technical Communities



HW/SW System Test Engineering Technical Community of Interest

925 people | Updated by MICHAEL J. HEALY | Yesterday 8:03 PM | Tags: community, firmware, fvt, group, hardware, integration, itcl, qse, software, stg, svt, systems, tc, tcc, technical, test

To provide a forum for Test professionals to access knowledge, confer with other experts, increase individual expertise, and share best practices and tools so IBM can improve efficiency, productivity, time to market, test technical innovation, and improve quality of STG products and solutions.



Quality Software Engineering (QSE)

9,159 people | Updated by Peter Smith | Today 6:25 AM | Tags: agile, practices, quality, software-engineering, softwareengineering, transformation, transformingibm

Quality Software Engineering (QSE) is a worldwide community of IBMers who share a commitment to improving the quality of our software. The QSE Community comes from many different organizations across IBM and from all areas of software engineering. Using our combined expertise and experience



Storage Systems Technical Community

1,211 people | Updated by MICHAEL J. HEALY | Yesterday 8:04 PM | Tags: disk, fibre-channel, iscsi, nas, san, ssd, storage, tape

This community is for people that have an interest in storage systems. The intent is to provide a forum for members to share knowledge related to storage systems and help improve their individual skills, foster innovation, and promote collaboration with other technical communities.

- ***These are just few examples from the list of over 70,000 communities within IBM.***

○ Academic Initiatives

IBM Academic Initiative
Open standards, open source and IBM resources for academia

I'd like to bring critical thinking on global issues into my classroom.

→ How can IBM help?

- Bring critical thinking into the classroom
- Help students gain real-world experience
- Get course material to teach competitive skills

What is the IBM Academic Initiative?
IBM Academic Initiative is a global program that facilitates the collaboration between IBM and educators to teach students the information technology skills they need to be competitive and keep pace with changes in the workplace.

Why should you join?
Become a member of the Academic Initiative to get no-charge access to hardware, full-version software, professionally developed courseware, tools, training, books, and discounts. Let us help you keep up with the latest technologies and reap the benefits of open source.

→ Learn more about membership Take a web site tour (9:59)

Membership

- Overview
- Join now
- Renew

Business Analytics and Optimization

→ Resources for the academic community

Minds of Modern Mathematics

Download free iPad app and take the interactive journey.

Software & system access
Full versions of hundreds of IBM software products, system access, and tools.
→ Get software & access

Courseware
Professionally developed courseware to help you enhance your curricula.
→ Get courseware

Learning guides
Skill building takes time. Let knowledge paths pave the way.
→ Build your skills

<https://www.ibm.com/developerworks/university/academicinitiative/>

○ Academic Initiatives

■ Introduction to Enterprise Systems Testing

○ Introduction to Enterprise Systems Testing

05 Dec 2011

This course introduces students to software and hardware testing. Lessons are taken from testing methodologies as practiced by the enterprise computing testers at IBM. The course is intended to facilitate the student's understanding of hardware and software testing theory and practice, the importance of testing in enterprise systems, and what it is like to test professionally. Theory and application of hardware and software enterprise systems will be covered, as will the primary tools of a mainframe environment.

[videos available by request (zskills@us.ibm.com)]

Skill Level: Introductory

Format: Semester

Language: English

<https://www14.software.ibm.com/webapp/devtool/scholar/web/coursewarePickPage.do?source=ai-course-systemz>

I would like to Thank:

Michael Browne, IBM Poughkeepsie, NY

Bill Carlson, IBM Poughkeepsie, NY

Lou Dickens, IBM Tucson, AZ

Mark Fleming, IBM Tucson, AZ

John D Gressett, IBM Rochester, MN

Rich Prewitt, IBM Poughkeepsie, NY

Aviad Zlotnick, IBM Haifa, Israel