

# **Sensor Based Risk Assessment for Dangerous Products Supply**

Dr. Laurent Gomez, SAP Research



**Sixth International Conference on Sensor Technologies and Applications**

**WSNSCM 2012**

**August 19 - 24, 2012 - Rome, Italy**

# RESCUEIT

secuREd ServiCe enabled sUPply chain connEctivity from  
the real world up to the world of IT

**1<sup>st</sup> ever German-French research project in Public Security**

**Leverage German French research funding**

**German-French Research Project, funded by BMBF / ANR**  
in the context of the “Securing the Supply Chains / “Concepts  
Systems and Tools for Global Security” call.

**Involves major actors of the supply chain**



# RESCUEIT in a Nutshell

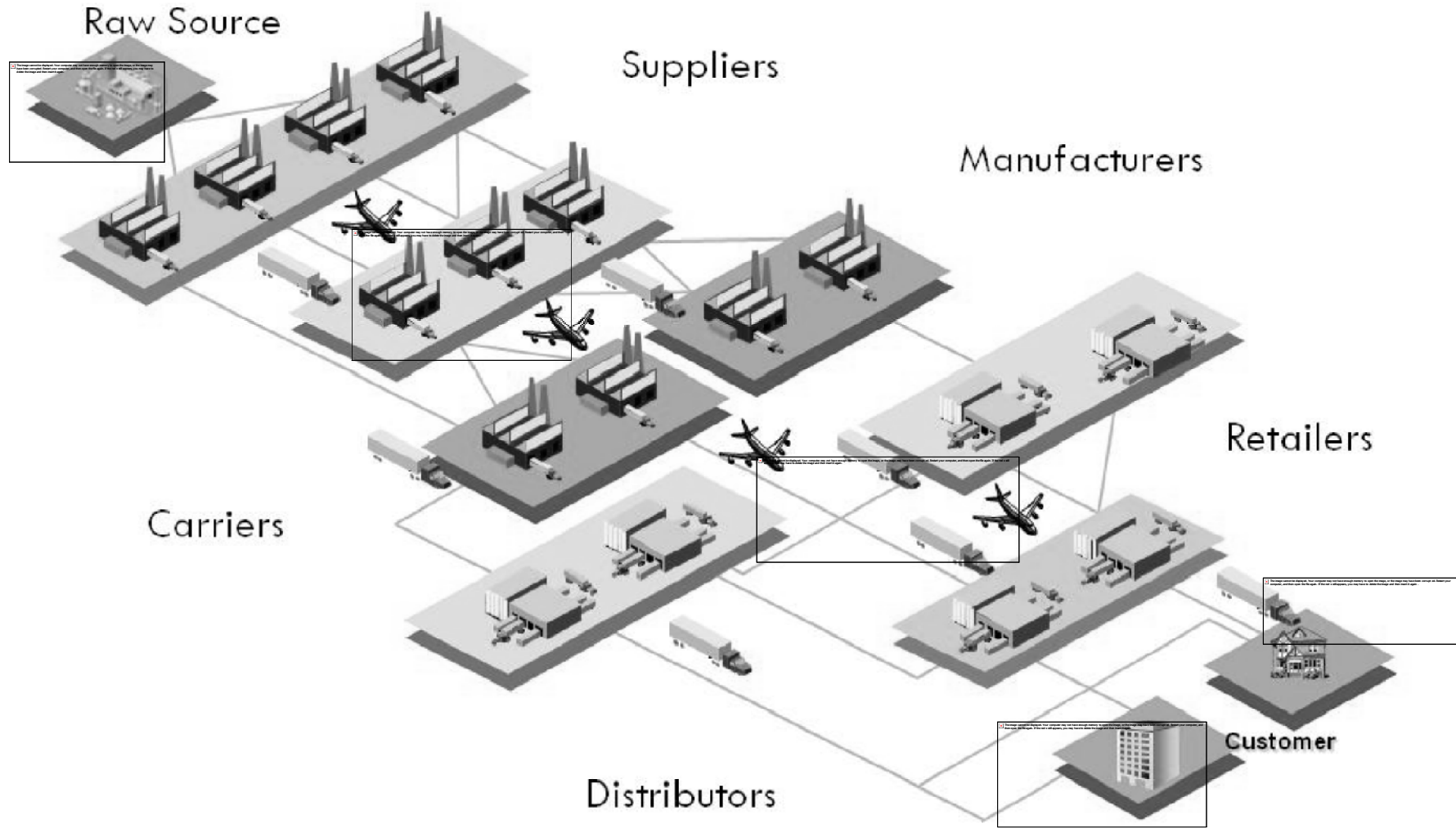

# RESCUEIT in a Nutshell

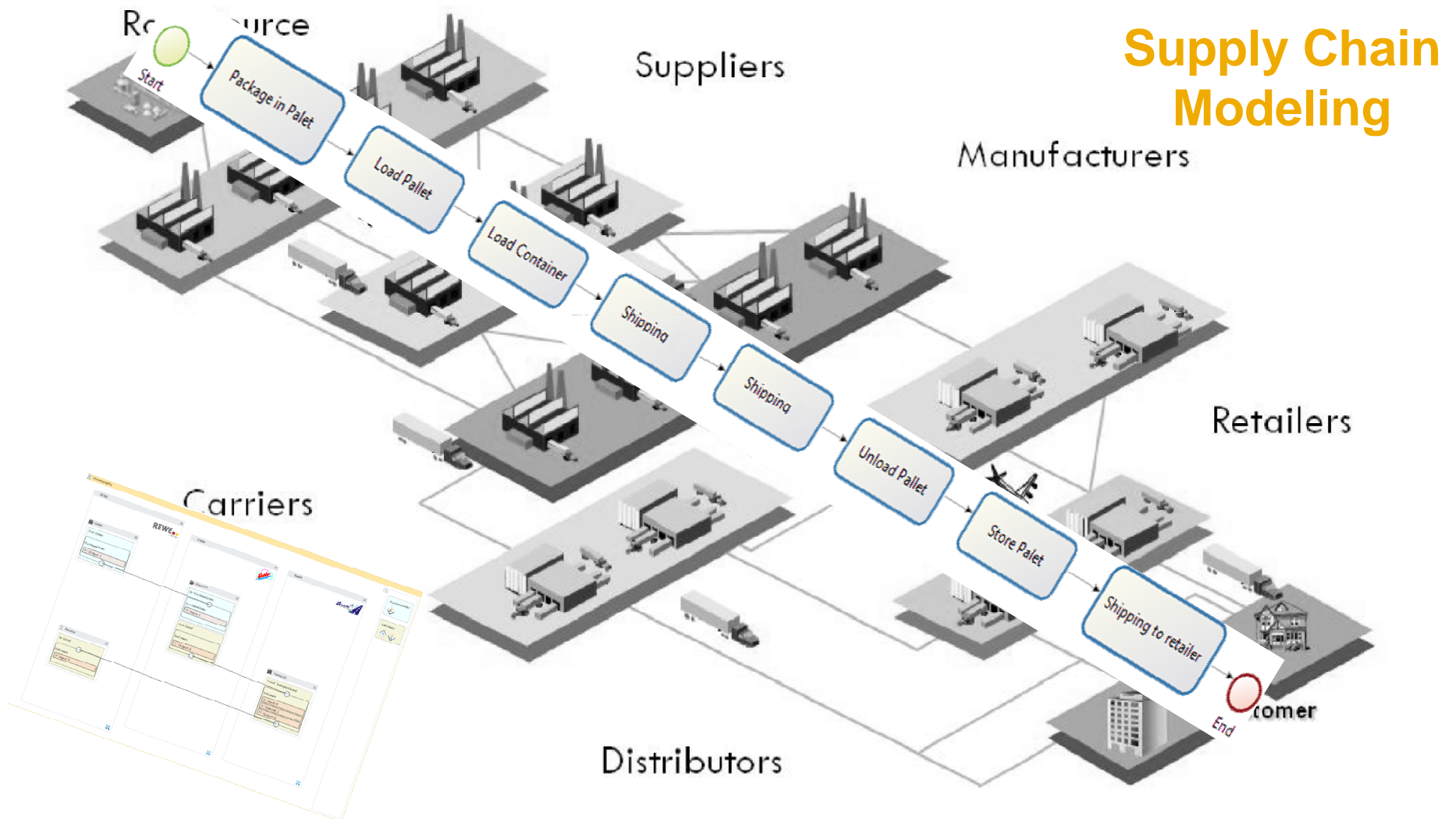

# Scenario

## Importation of dangerous products to Europe

---

Dangerous products are imported from China;  
Products are shipped by boat to Le Havre harbor;  
After customs check, products are shipped to a K+N warehouse;  
Products are shipped by truck to the retailer storage units



# RESCUEIT in a Nutshell

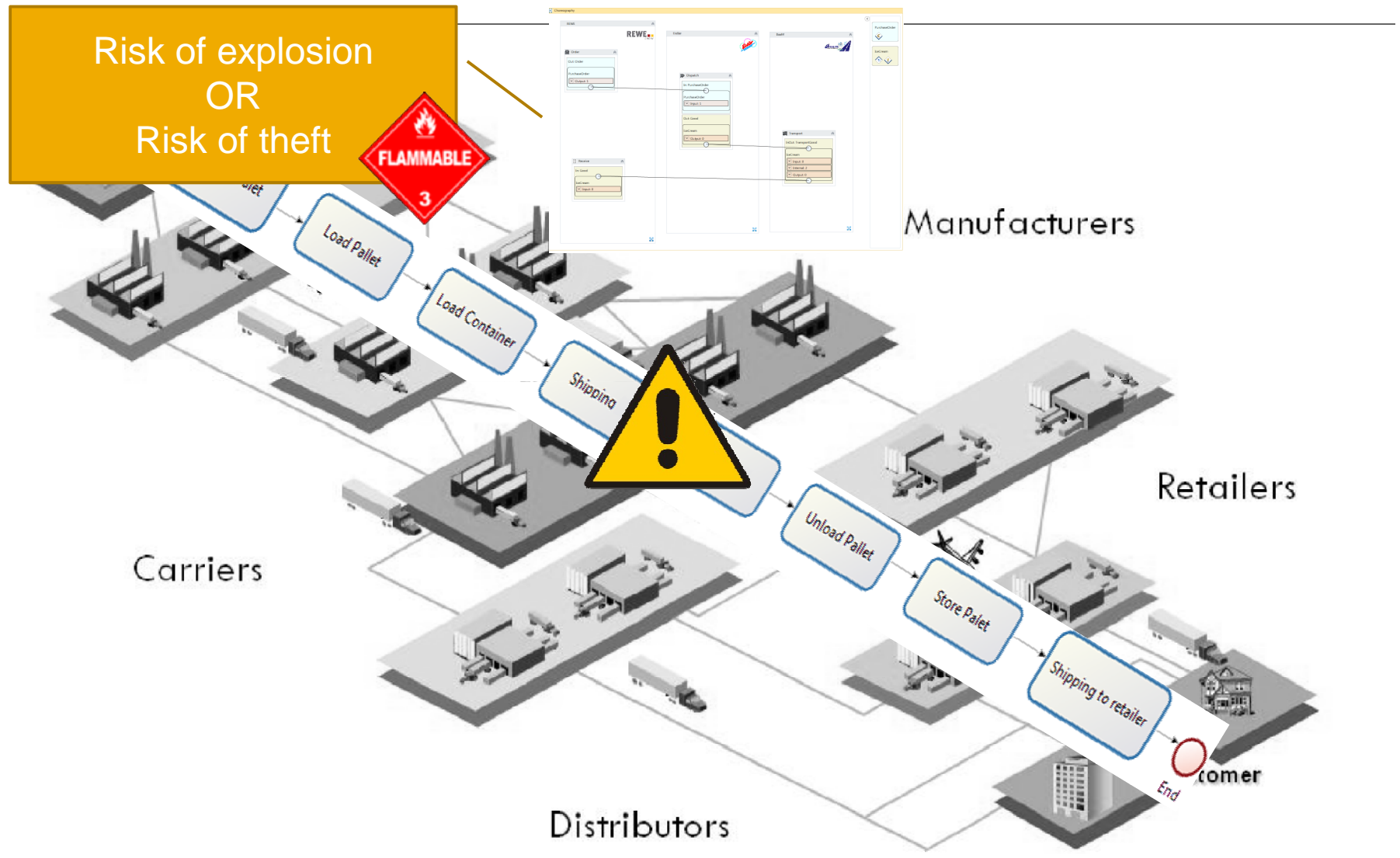

## Products identified as dangerous products stored in K+N warehouse classified SEVESO II

---

### **Detergent - ICPE 1412**

Harmful and polluting liquids

Flash point 66 celsius degrees

Must not be mixed with acid, bases or oxidizing

Risk of fire, if exposed to high temperature

### **Aerosol – ICPE 1432**

Restricted quantity in a single location

Flash point 13 celsius degrees

Muts not be in contact with metal and acids

Risk of fire, if exposed to high temperature

# Impact on the population and environment

---

## Fire

Merchandises and packaging highly inflammable

## Toxic gas emission

Lethal consequence on individuals

Under the effect of heat, emission of hydro-cyanic acid or oxides of sulphur.

## Dispersion of extinction waters

Containing water plus chemical, foam, powder

May pollute surface or underground waters.

## Food contamination



# Compliance with dangerous products regulation

---

## Regulation compliance along the supply chain

Manipulation, shipping, storage of dangerous products

“In order to ensure compliance with the safety regulations, shipped goods have to be identified together with their classification (e.g. flammable, explosive).”

## European Chemicals Regulation

REACH (Regulatory framework for the management of chemicals)

### At the French level

ICPE (« Installation Classes pour la Protection de l'Environnement »).

Units classified as SEVESO I/II for the storage of dangerous goods.

## Problem

---

**All the supply chain actors are not subject to the same regulations**

**Because they are not at the same location**

Chinese regulation vs European regulations vs boat shipment regulations

**Because they are subject to the same classification**

K+N warehouse has to be classified SEVESO II in order to store chemical

Retailer warehouse has no specific storage constraints

Risk of food contamination with leakage of liquid detergent

**There is no overall risk assessment at the execution of the supply chain**

**How to evaluate risk at the execution of the supply chain process without any disruption?**

# RESCUEIT in a Nutshell

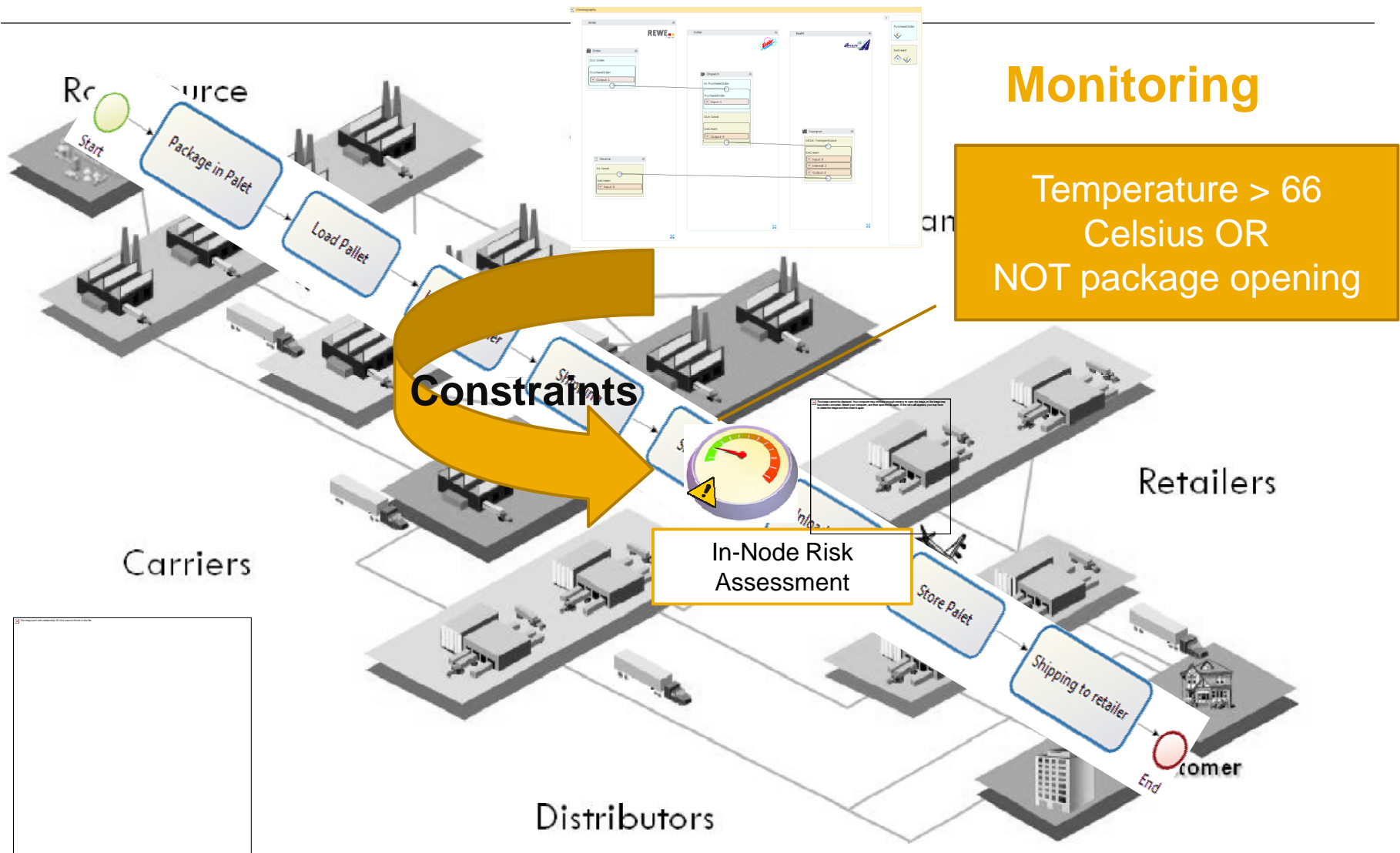

# Delegation of risk assessment to Sensor

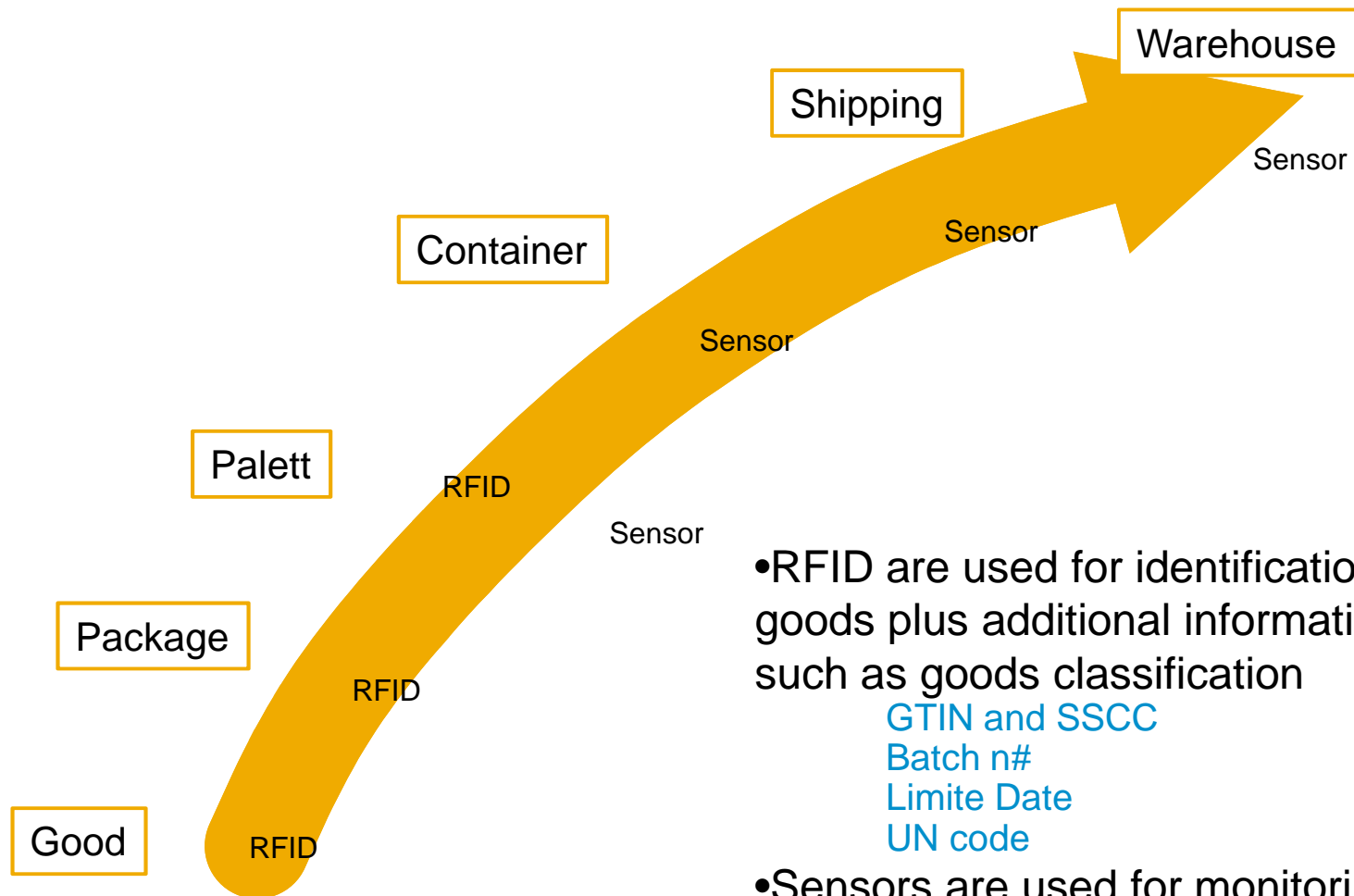

- RFID are used for identification of goods plus additional information such as goods classification

- GTIN and SSCC
- Batch n#
- Limite Date
- UN code

- Sensors are used for monitoring the supply chain, and risk identification

## Identified constraints

---

### Identification of constraints per good classification

ICPE 1172 - squashing, overturn, container opening, liquid leakage

ICPE 1412 – overheating (13°C), squashing, overturn, container opening

ICPE 1432 - overheating (66°C), squashing, overturn, container opening

### Container opening

Light monitoring

Secure lock

### Squashing/overturn

Acceleration pattern

### Liquid leakage

Detection of packaging opening, or shock on the products

# RESCUEIT in a Nutshell

Alerting

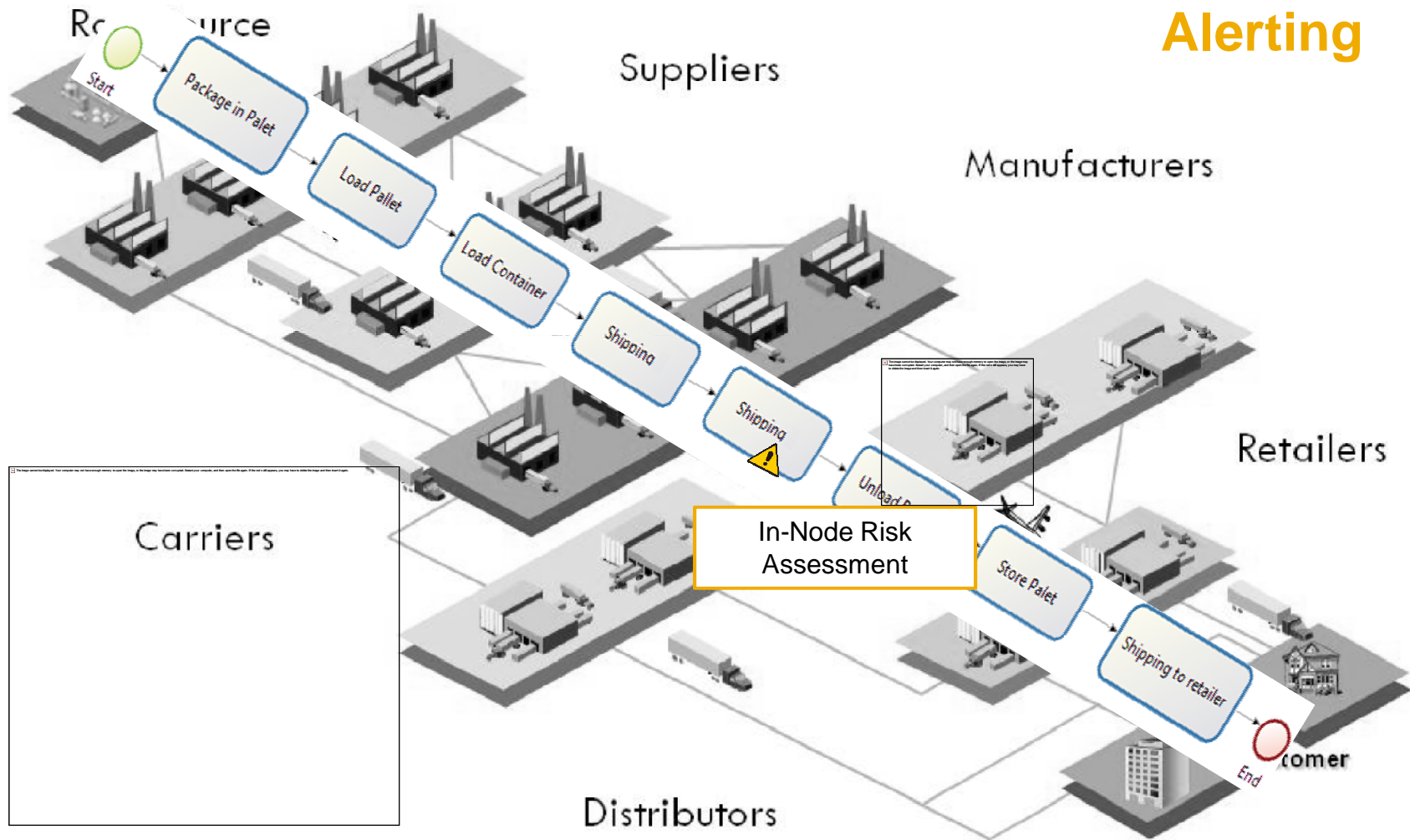

# Terminology

---

# Roadmap

---



# Constraint Extraction

## Based on regulations

Flash point

Stability

Container/packaging opening

Humidity constraints

Incompatibility between products

Limited of quantity of product stored at the same location

Liquid leakage

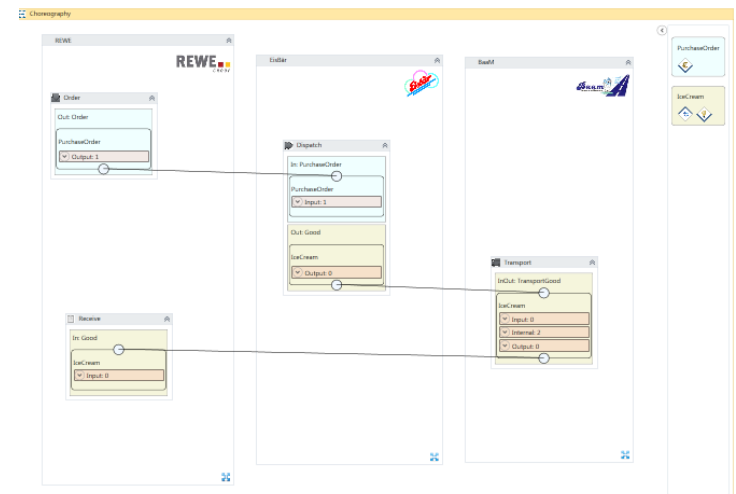

# Constraint Extraction

---

## **Based on activity of the assets**

Storage, Manipulation, Shipping

## **Based on geo localization**

EU, Asia

K+N warehouse, retailer warehouse

## Constraint Distribution on Nodes

---

### Set of Constraint to be uploaded on sensor nodes

node identifier, constraint identifier,

Type of sensor data, Operation, Threshold

***“TEMPERATURE on Node 21 > 27 Celsius.”***

### Byte-code upload

Enablement of combination of constraints

***“TEMPERATURE on Node 21 > 27 Celsius.” AND***

***“LIGHT on Node 21 > 400 Lux.”***

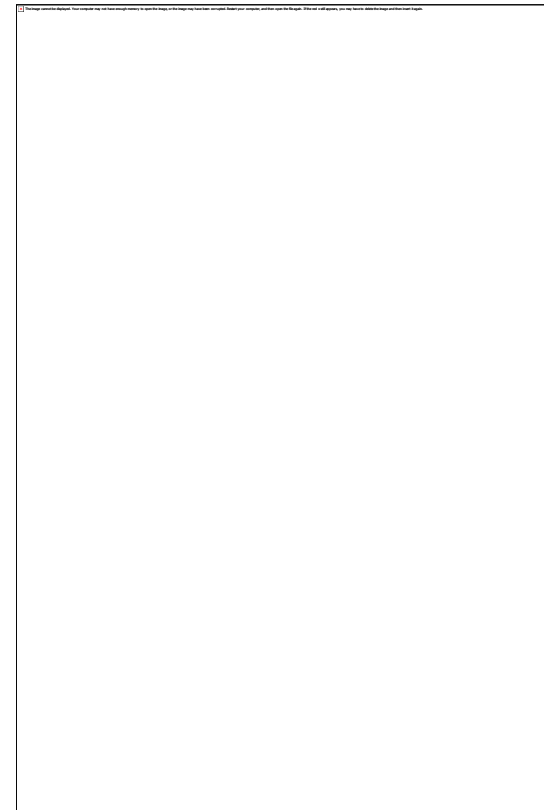

# Constraint Evaluation on Nodes

## Execution of constraint byte-code

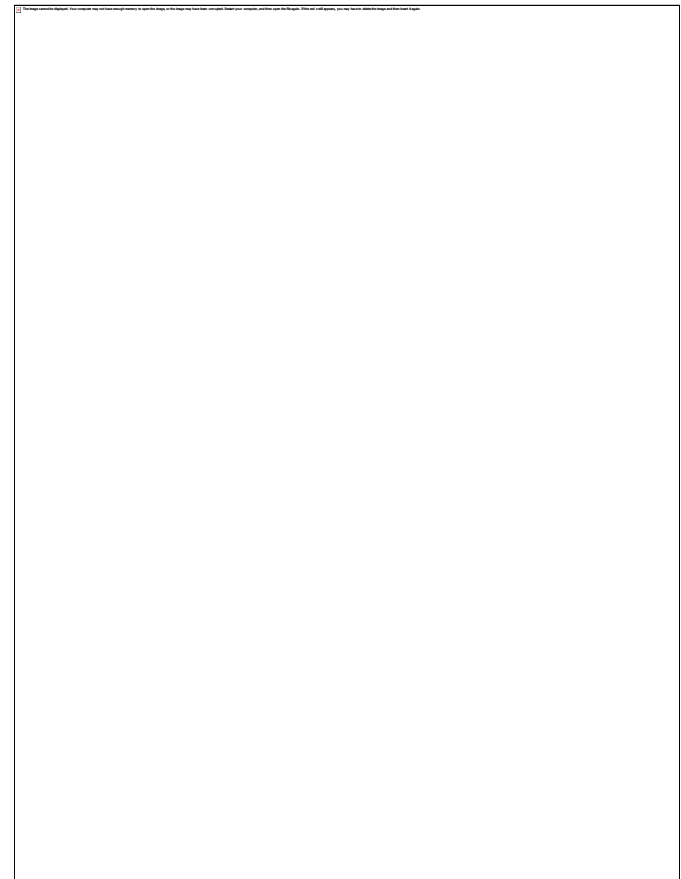

# Alerting

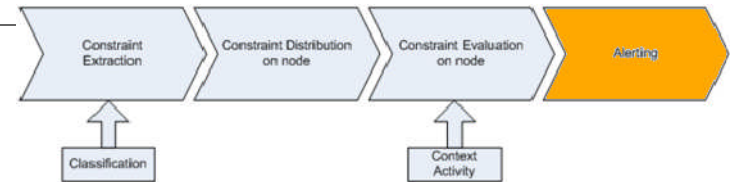

**Whenever constraint byte-code detects any constraint violation, an alert is triggered.**

# Overall Architecture

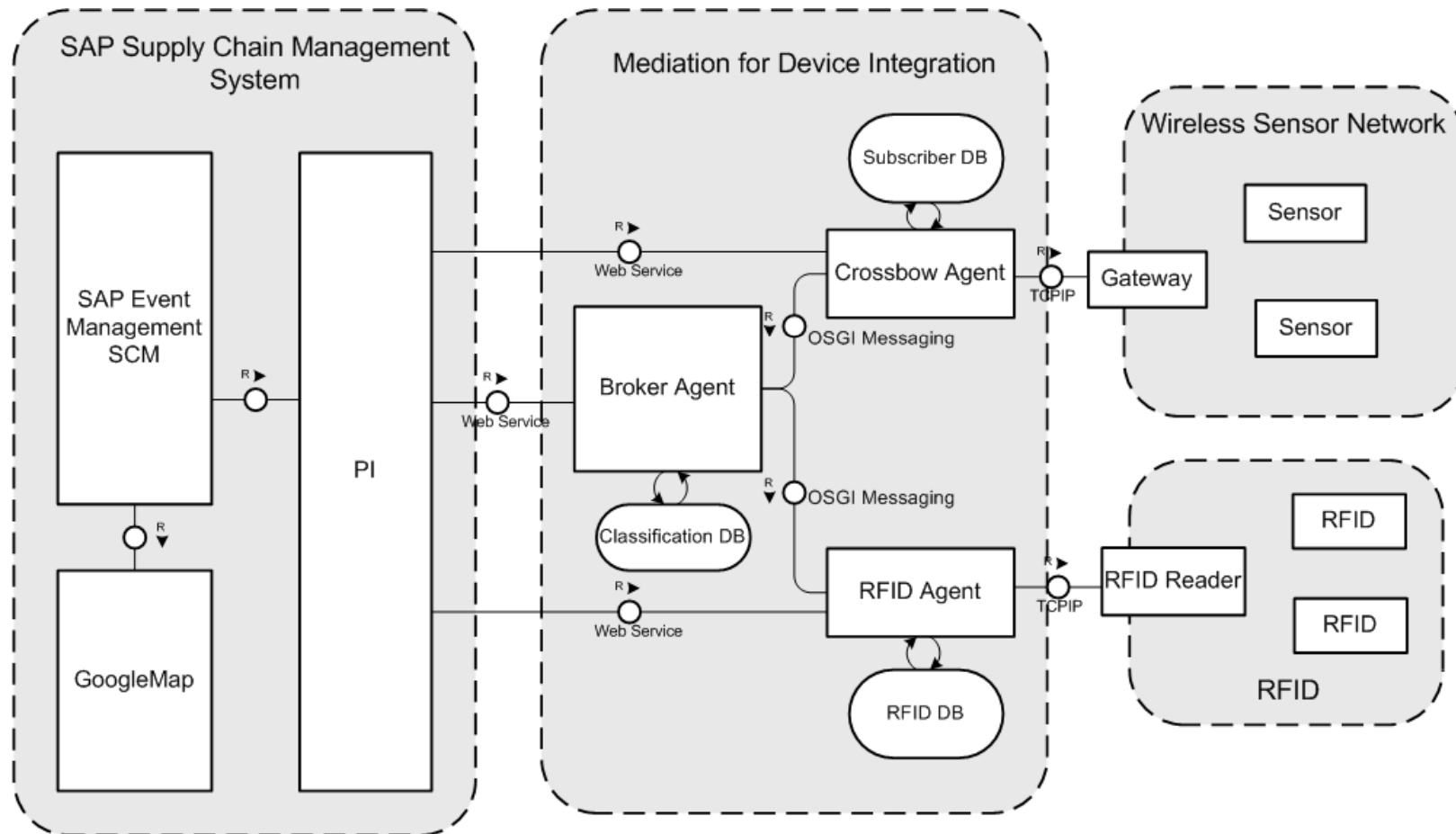

# Overall Architecture SAP Supply Chain Management System

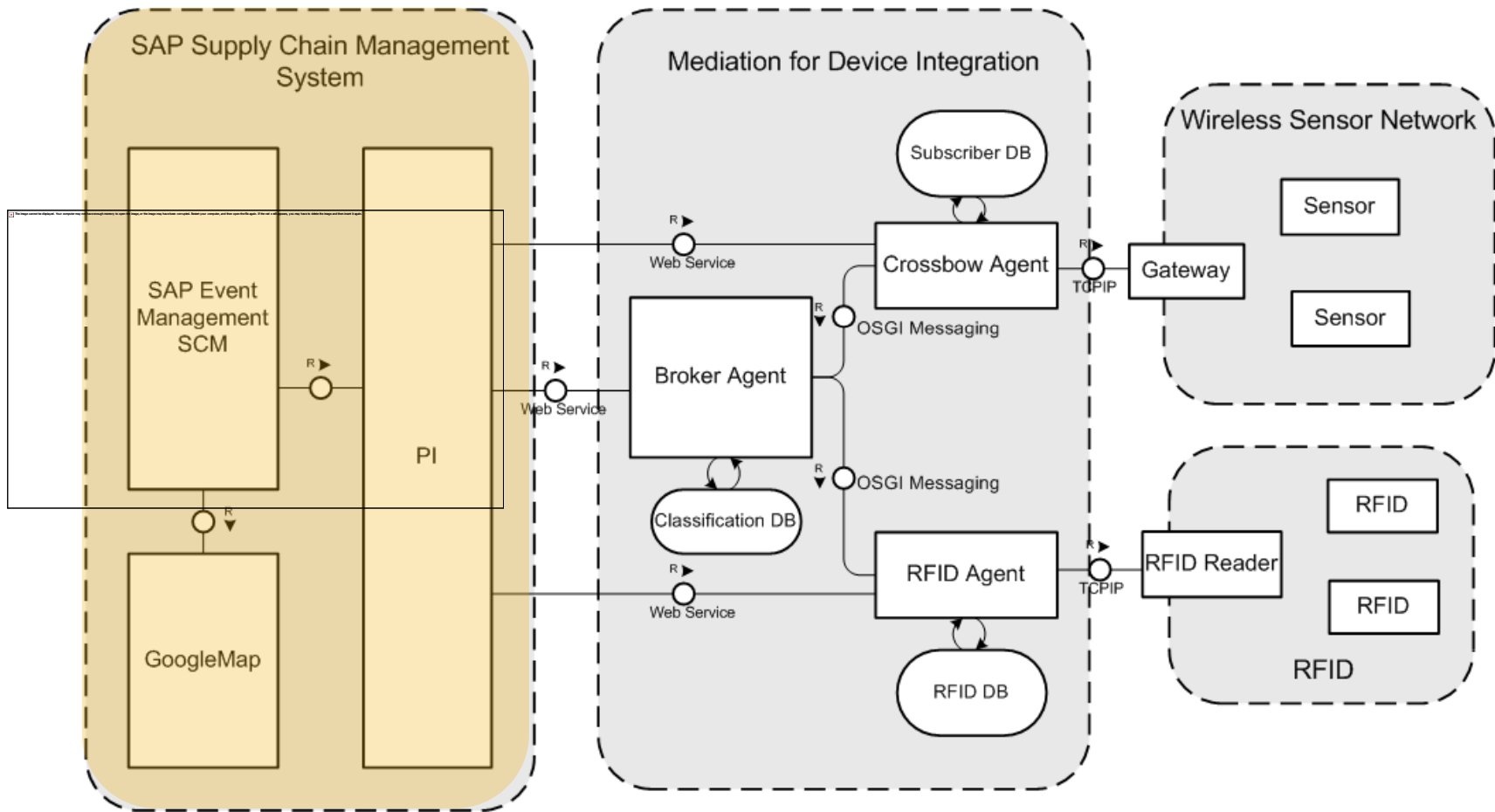

# Overall Architecture Wireless Sensor / RFID

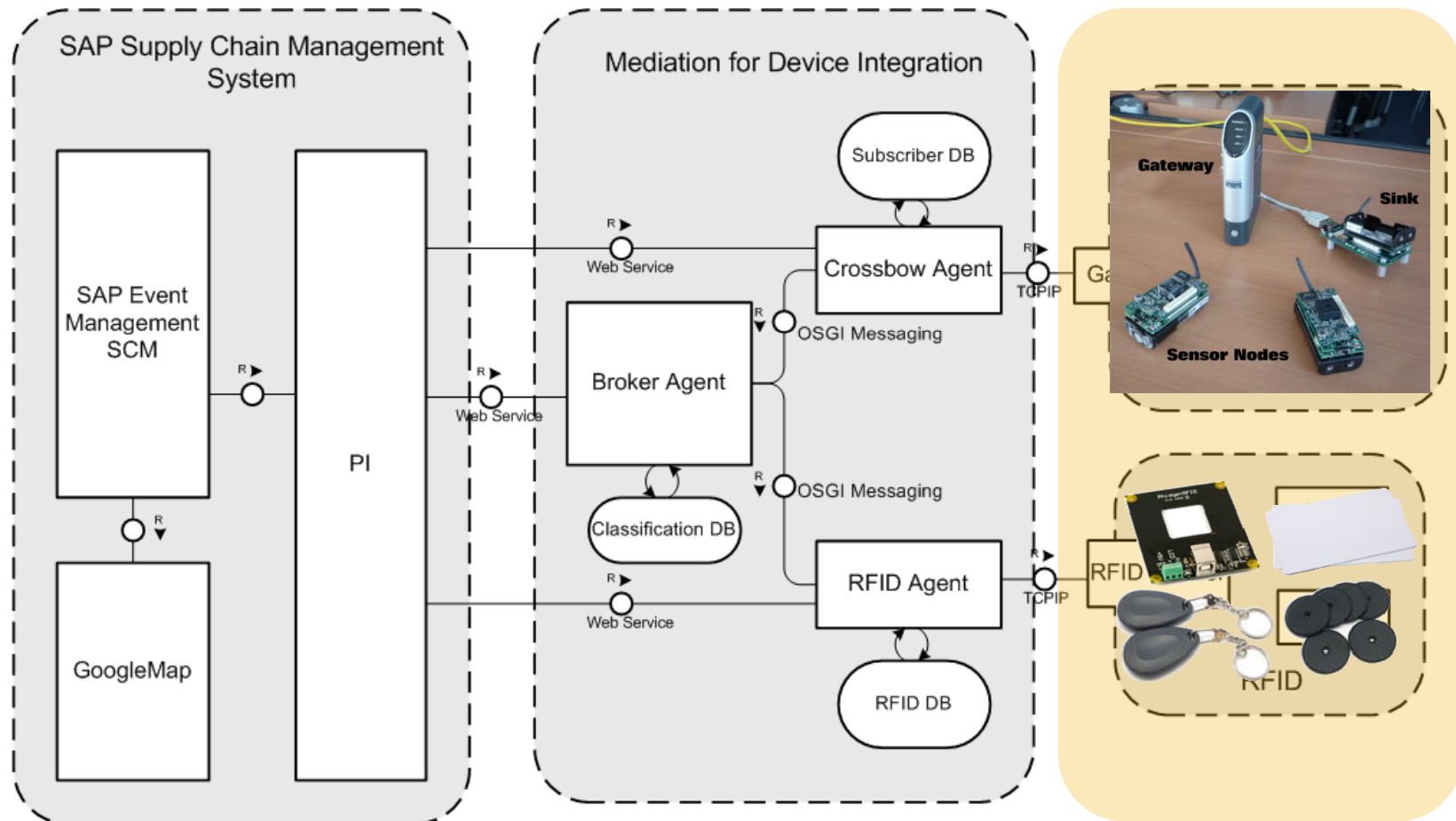



# Overall Architecture Mediation for Device Integration

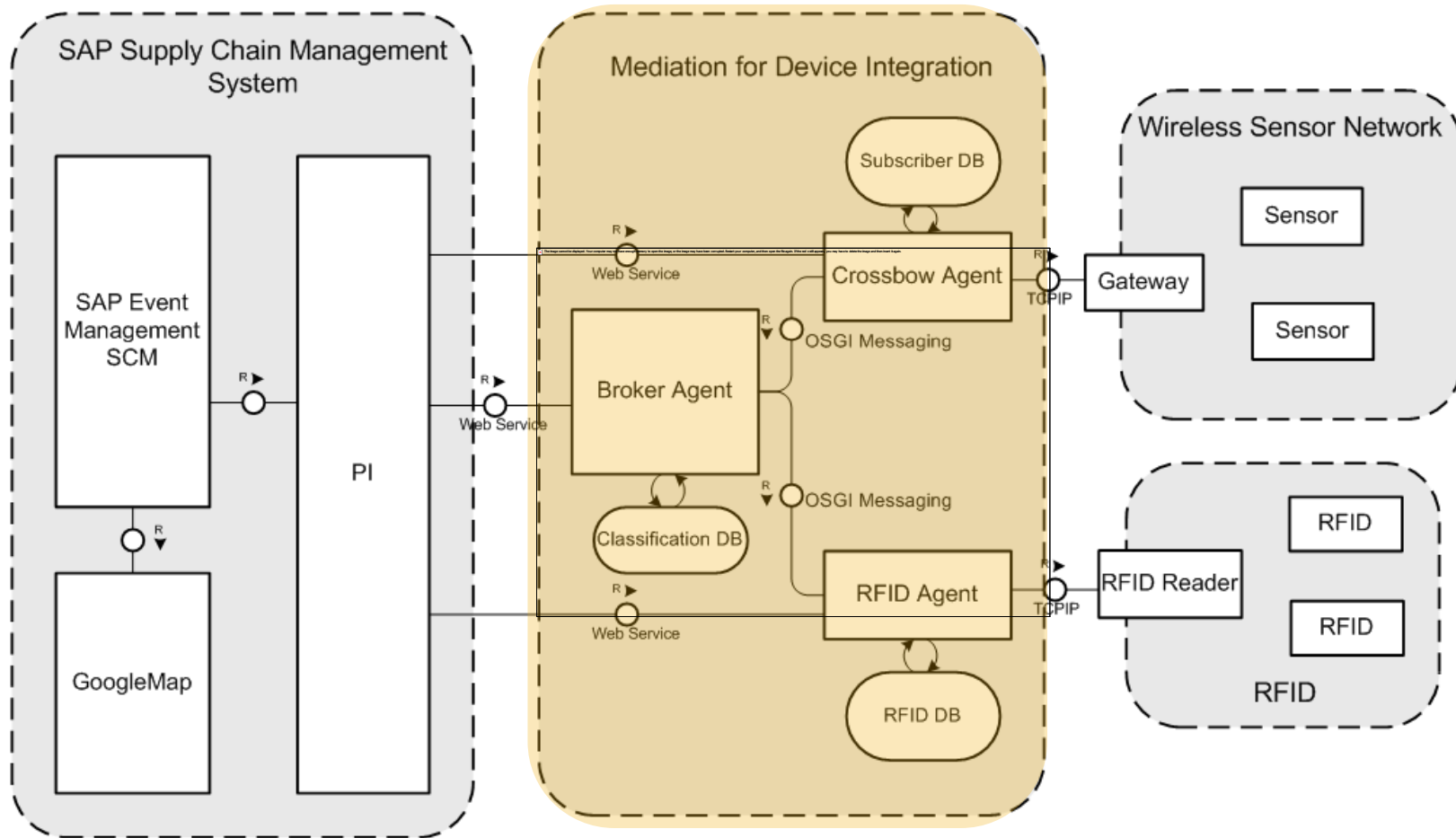

# Middleware for Device Integration

## Node resource restriction

CPU, memory, battery

## Lack of standardization

Proprietary communication protocol,

Proprietary sensor data format

## Information flooding

## Lack of security

## Unreliability of sensors

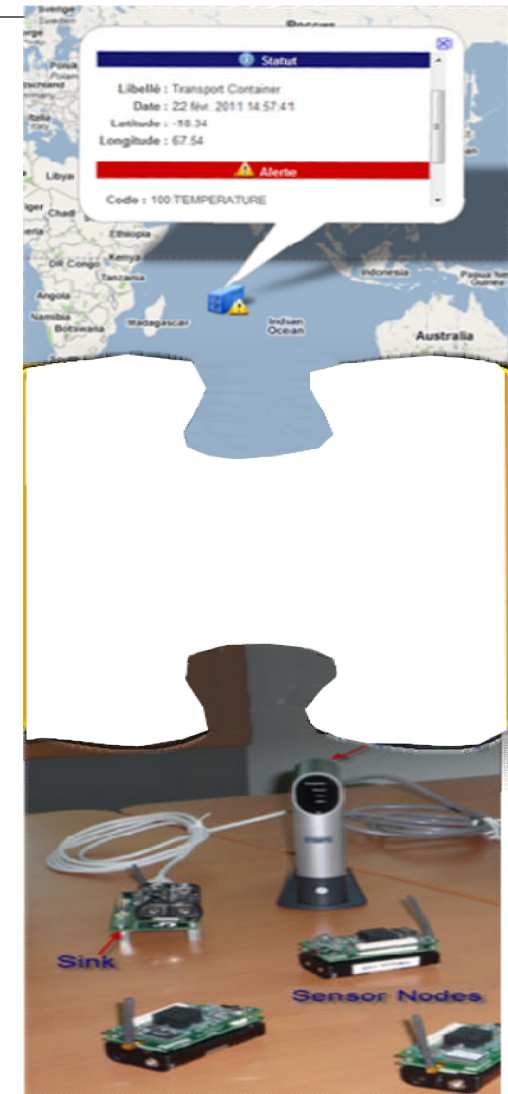

# Middleware for Device Integration a SAP research Prototype

---

**Need for a mediation layer for a seamless integration**  
between smart items and supply chain management system

**Delegation of information processing**  
for energy saving

**Security mechanisms**

## MDI in a nutshell

---

**Based on OSGi platform organized around agents**

**Logical Agent for sensor data processing**

**Adapter Agent for sensor data acquisition**

**Each agent exposes a Web Service interface, and enable OSGi communication locally.**

## Site Manager the MDI Cockpit

---

**Site manager provides an overall view on available devices.**

**A device is represented as an Agent.**

**Site Manager is in charge of**

Agent Instantiation

Agent Configuration

Agent launching

# Purchase Order Generation

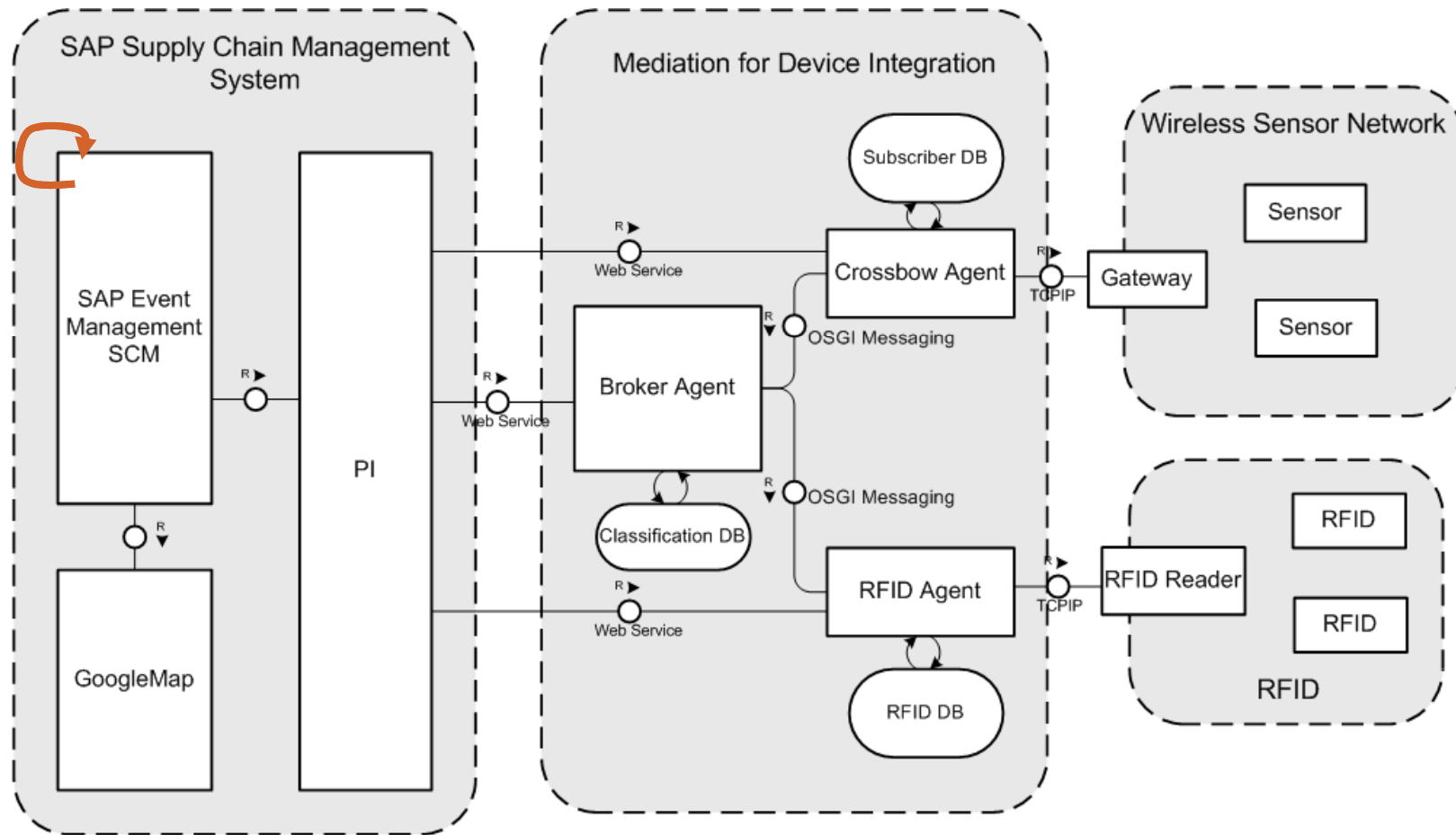

# Subscription to good monitoring per classification

## PurchaseOrderId, Classification, Subscriber

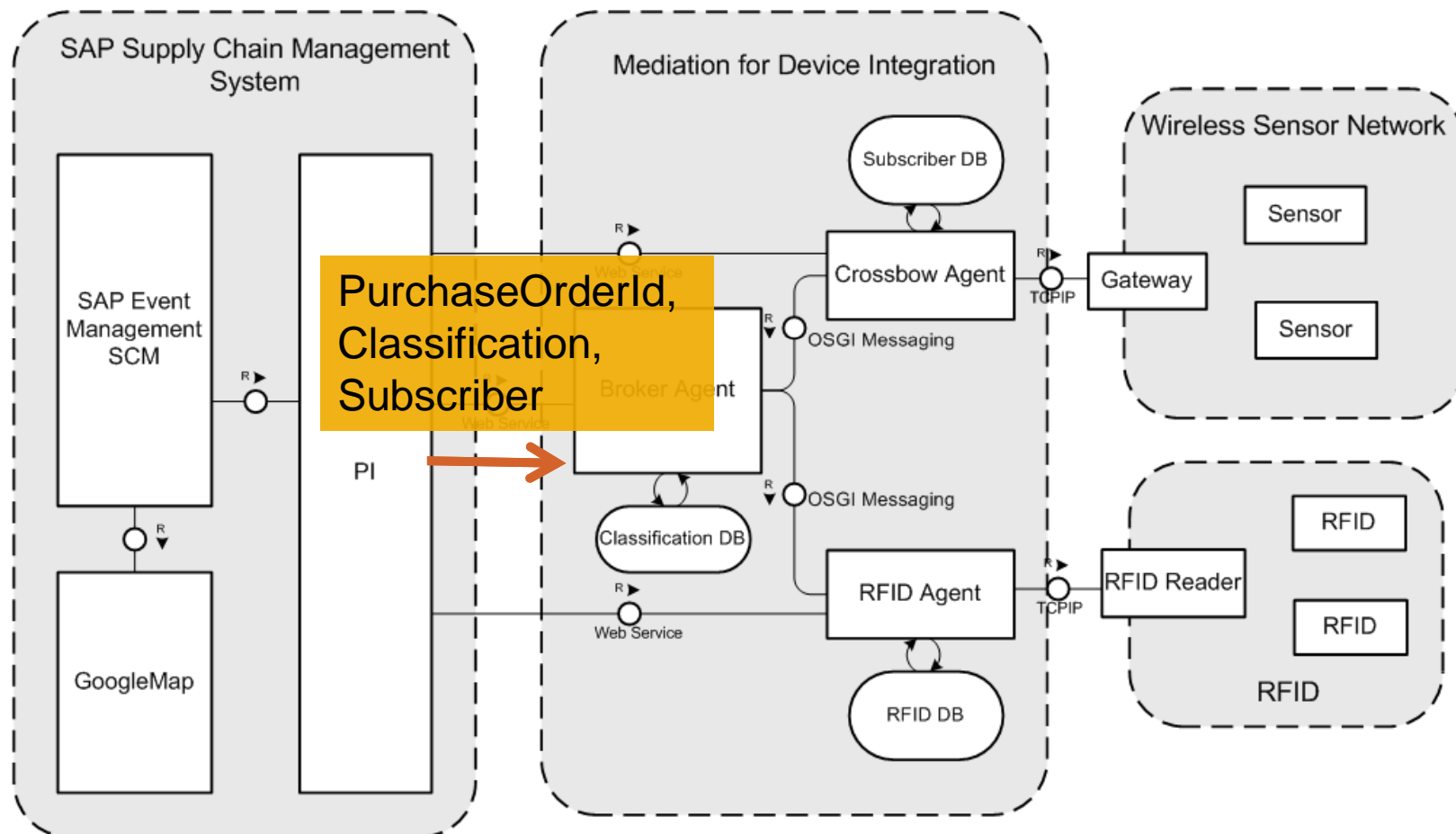

# Subscription to good monitoring per classification

## Constraint extraction per classification

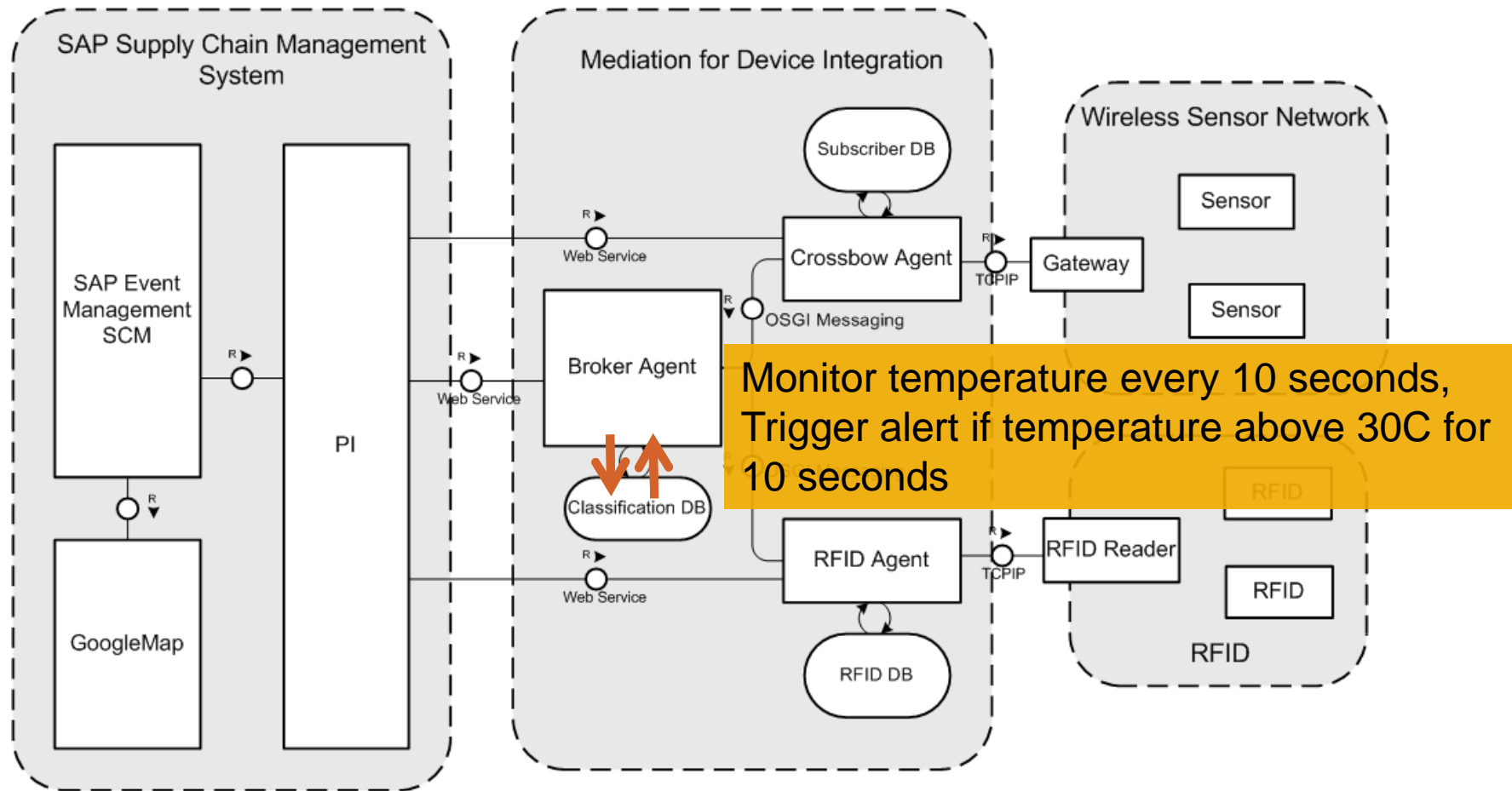



# Subscription to good monitoring per classification

## Constraint extraction per classification

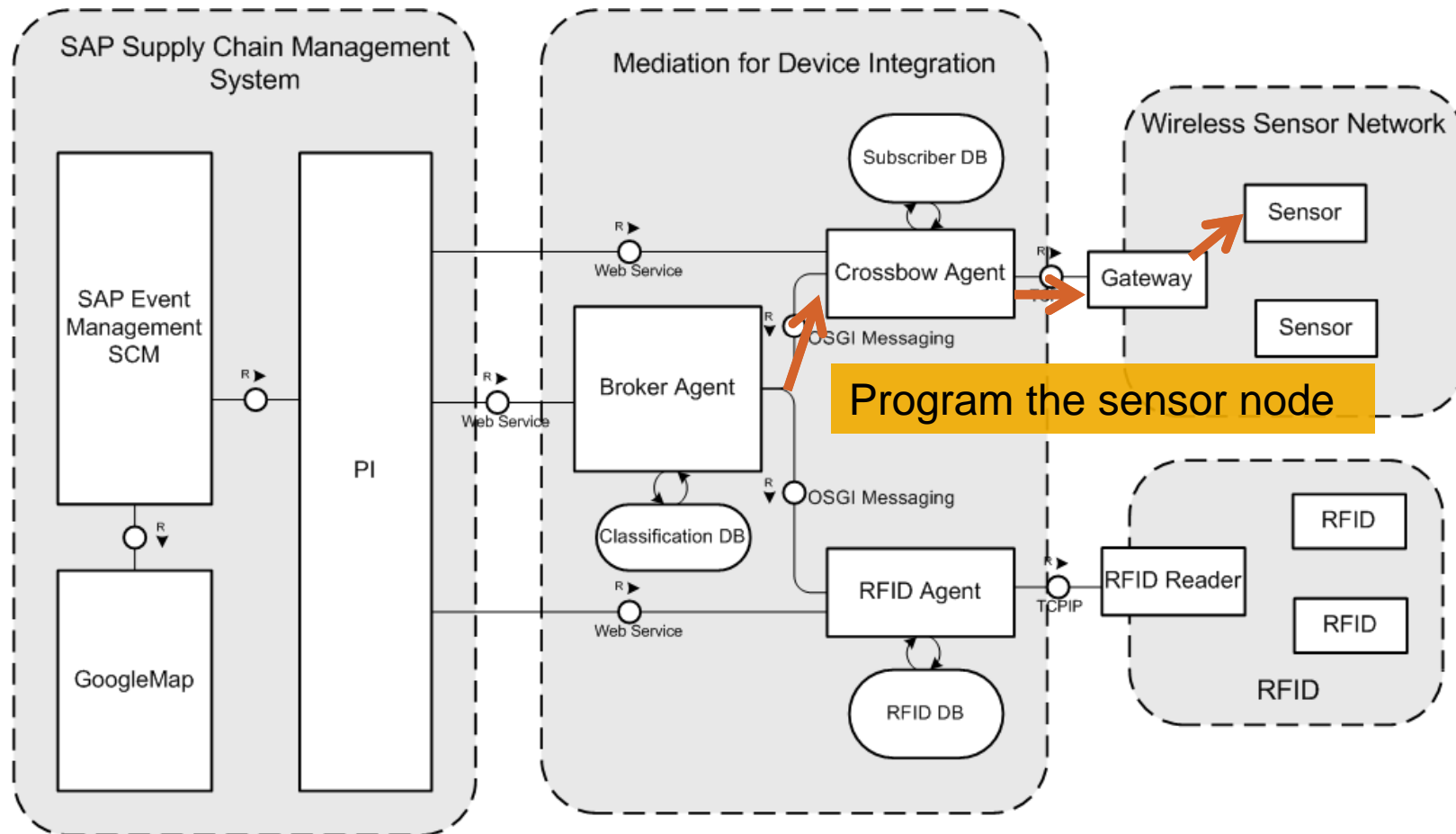

# Notification of status change

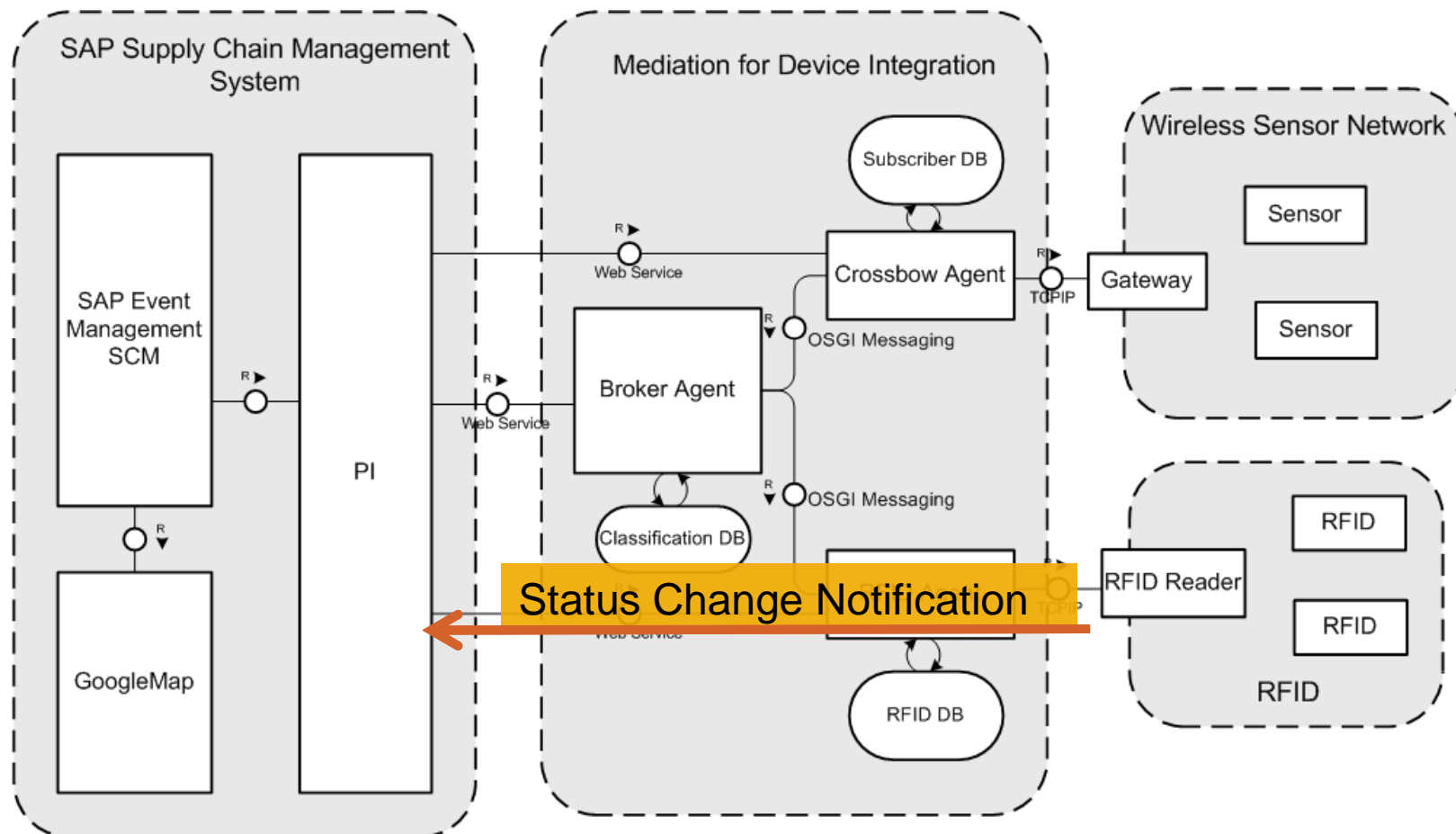

# Notification of sensor event

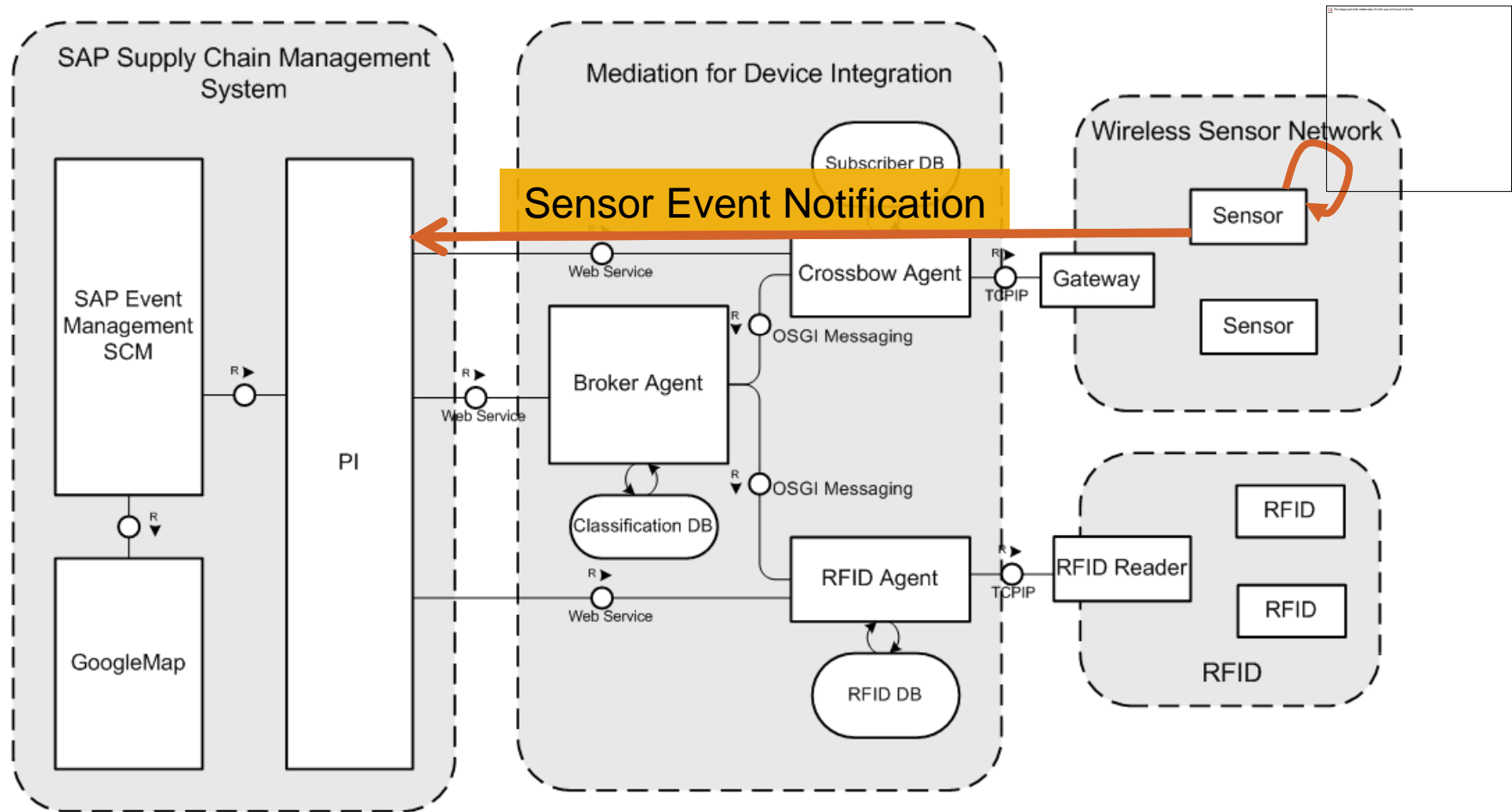

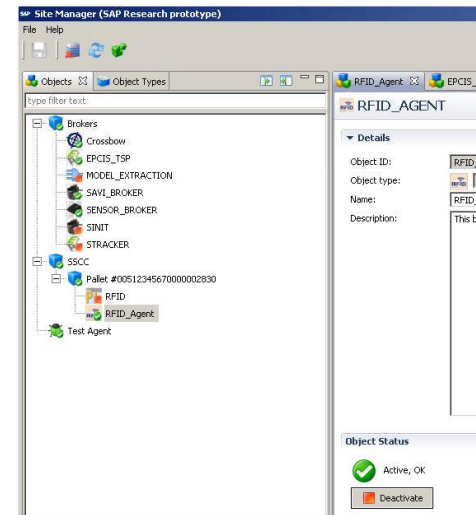
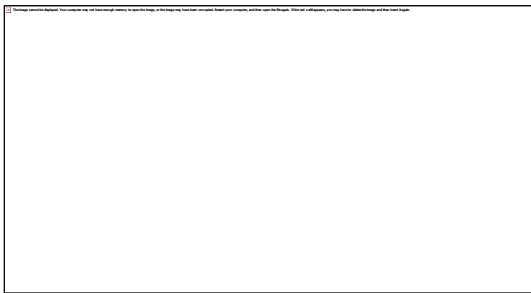
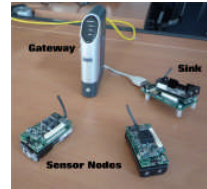
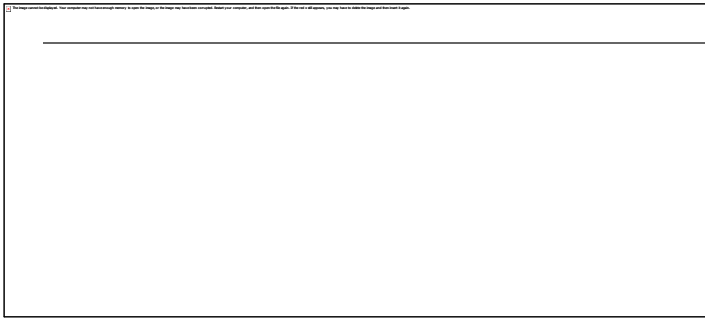

## Hardware Setup: CrossBow sensor node

---

### Hardware

MICAz (MPR2400) processing and programmable unit (TinOS, with NesC)

MTS310CA sensor board equipped with acceleration, light and temperature sensors

### Energy:

2 1.2V rechargeable battery with a capacity of 2200mA/h

## Four evaluation scenarios

---

**Packet sending every 30 seconds**

**Monitoring and packet sending every 30 seconds**

**Monitoring, constraint evaluation and packet sending every 30 seconds**

**Monitoring, constraint evaluation, and alerting.**

## Battery overhead

---

**Negligible overhead of evaluation of constraint violation.**

**Following alerting strategies, we observe a gain in energy consumption of almost 60%.**

## Memory overhead

---

**10% of the loaded code in ROM is dedicated to constraint evaluation**

**10% of the used RAM is dedicated to constraint evaluation**

Bytecode

Set of constraints



# Conclusion

---

## **Sensor based risk assessment for supply of dangerous products.**

Cope with disruption of risk evaluation at the execution of the supply chain.

Prototype developed in the scope of the RESCUEIT project

## **Future work**

Confidentiality of the alerts and monitoring information

Keep a trace of the alerts on the nodes (black box approach)



# Thank you!

Contact Information:

*Dr. Laurent Gomez*  
Project Lead RESCUEIT-FR  
SAP Research, Sophia Antipolis,  
[laurent.gomez@sap.com](mailto:laurent.gomez@sap.com)

# © 2011 SAP AG. All rights reserved

No part of this publication may be reproduced or transmitted in any form or for any purpose without the express permission of SAP AG. The information contained herein may be changed without prior notice.

Some software products marketed by SAP AG and its distributors contain proprietary software components of other software vendors.

Microsoft, Windows, Excel, Outlook, and PowerPoint are registered trademarks of Microsoft Corporation.

IBM, DB2, DB2 Universal Database, System i, System i5, System p, System p5, System x, System z, System z10, System z9, z10, z9, iSeries, pSeries, xSeries, zSeries, eServer, z/VM, z/OS, i5/OS, S/390, OS/390, OS/400, AS/400, S/390 Parallel Enterprise Server, PowerVM, Power Architecture, POWER6+, POWER6, POWER5+, POWER5, POWER, OpenPower, PowerPC, BatchPipes, BladeCenter, System Storage, GPFS, HACMP, RETAIN, DB2 Connect, RACF, Redbooks, OS/2, Parallel Sysplex, MVS/ESA, AIX, Intelligent Miner, WebSphere, Netfinity, Tivoli and Informix are trademarks or registered trademarks of IBM Corporation.

Linux is the registered trademark of Linus Torvalds in the U.S. and other countries.

Adobe, the Adobe logo, Acrobat, PostScript, and Reader are either trademarks or registered trademarks of Adobe Systems Incorporated in the United States and/or other countries.

Oracle is a registered trademark of Oracle Corporation.

UNIX, X/Open, OSF/1, and Motif are registered trademarks of the Open Group.

Citrix, ICA, Program Neighborhood, MetaFrame, WinFrame, VideoFrame, and MultiWin are trademarks or registered trademarks of Citrix Systems, Inc.

HTML, XML, XHTML and W3C are trademarks or registered trademarks of W3C®, World Wide Web Consortium, Massachusetts Institute of Technology.

Java is a registered trademark of Sun Microsystems, Inc.

JavaScript is a registered trademark of Sun Microsystems, Inc., used under license for technology invented and implemented by Netscape.

SAP, R/3, SAP NetWeaver, Duet, PartnerEdge, ByDesign, SAP BusinessObjects Explorer, StreamWork, and other SAP products and services mentioned herein as well as their respective logos are trademarks or registered trademarks of SAP AG in Germany and other countries.

Business Objects and the Business Objects logo, BusinessObjects, Crystal Reports, Crystal Decisions, Web Intelligence, Xcelsius, and other Business Objects products and services mentioned herein as well as their respective logos are trademarks or registered trademarks of Business Objects Software Ltd. Business Objects is an SAP company.

Sybase and Adaptive Server, iAnywhere, Sybase 365, SQL Anywhere, and other Sybase products and services mentioned herein as well as their respective logos are trademarks or registered trademarks of Sybase, Inc. Sybase is an SAP company.

All other product and service names mentioned are the trademarks of their respective companies. Data contained in this document serves informational purposes only. National product specifications may vary.

The information in this document is proprietary to SAP. No part of this document may be reproduced, copied, or transmitted in any form or for any purpose without the express prior written permission of SAP AG.

This document is a preliminary version and not subject to your license agreement or any other agreement with SAP. This document contains only intended strategies, developments, and functionalities of the SAP® product and is not intended to be binding upon SAP to any particular course of business, product strategy, and/or development. Please note that this document is subject to change and may be changed by SAP at any time without notice.

SAP assumes no responsibility for errors or omissions in this document. SAP does not warrant the accuracy or completeness of the information, text, graphics, links, or other items contained within this material. This document is provided without a warranty of any kind, either express or implied, including but not limited to the implied warranties of merchantability, fitness for a particular purpose, or non-infringement.

SAP shall have no liability for damages of any kind including without limitation direct, special, indirect, or consequential damages that may result from the use of these materials. This limitation shall not apply in cases of intent or gross negligence.

The statutory liability for personal injury and defective products is not affected. SAP has no control over the information that you may access through the use of hot links contained in these materials and does not endorse your use of third-party Web pages nor provide any warranty whatsoever relating to third-party Web pages.