

ADVANCED SIGNAL PROCESSING FOR MEDICAL TECHNOLOGIES AS NON-INVASIVE DIAGNOSTIC SYSTEMS FOR NON-VISIBLE INTERNAL INJURY

**Key Note Presentation at
INFOCOMP 2012/IMMM2012
Global Health 2012
VENICE, ITALY 21-26 of October 2012**

by
Stergios Stergiopoulos, PhD
• **Defence R&D Canada Toronto**
• **Dept. ECE, University of Toronto**



Influence of Defence Oriented Signal Processing in Medical Imaging Technologies

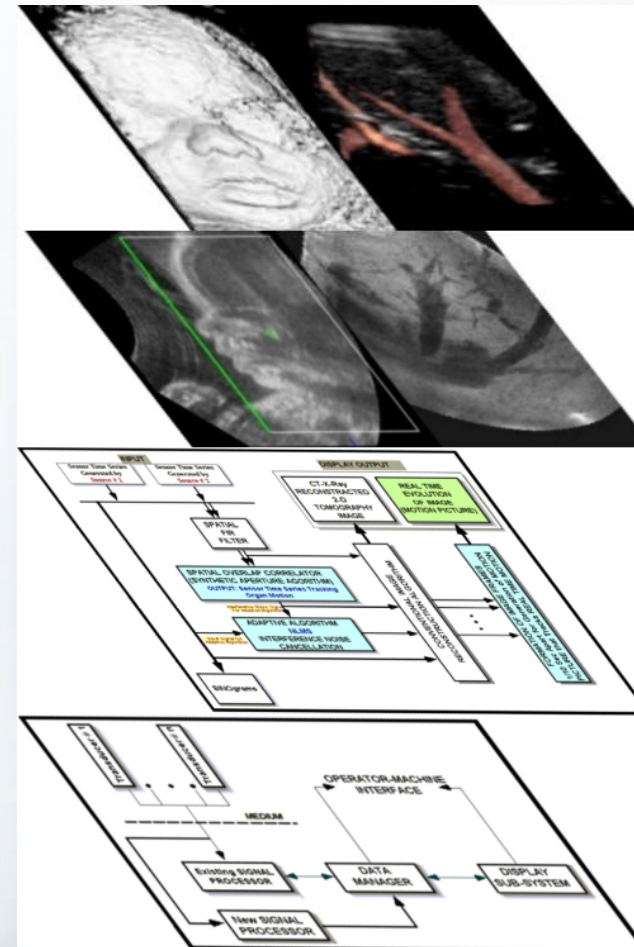
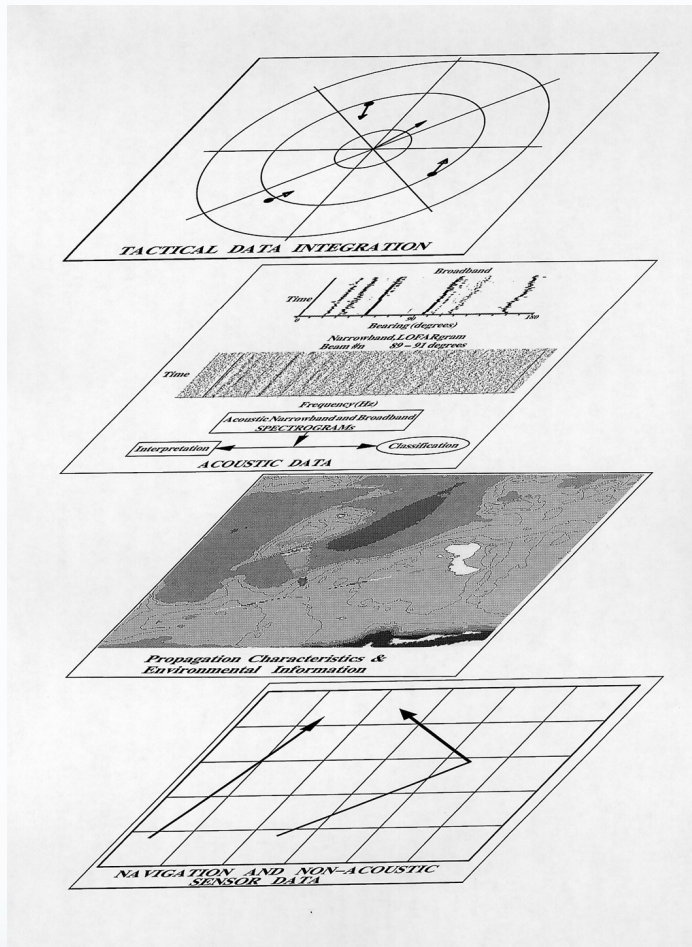

The Role of Computing Architecture in DSP System Development Projects



Limitations in Computing Architecture Technology generated a narrow point of view in developing the DSP functionality of sonar, radar and medical imaging systems

To Address Practical Implementation Issues, ad-hoc solutions were sought to address DSP design problems. This situation generated differences in the DSP system functionality of the systems of interest.

Recent Advancements in Computing Architecture Technology have narrowed the differences in DSP functionality among the systems of interest and generated the momentum to developing optimum DSP system solutions.

Development of Optimum Solutions in DSP System Functionality Leads to exploitation of system experience and signal processing concept similarities among sonar, radar and medical imaging systems

Optimum Use of Adaptive Schemes Requires, Synergism with Main-Stream Conventional processing through a Generic processing Structure

Adaptive Processing Techniques Can Improve Array Gain Performance for Signals embedded in Anisotropic Noise. Their Implementation, however, requires consideration of the temporal coherence properties of the receiving system to estimate the adaptive noise cancellation weights

Generic Processing Structure

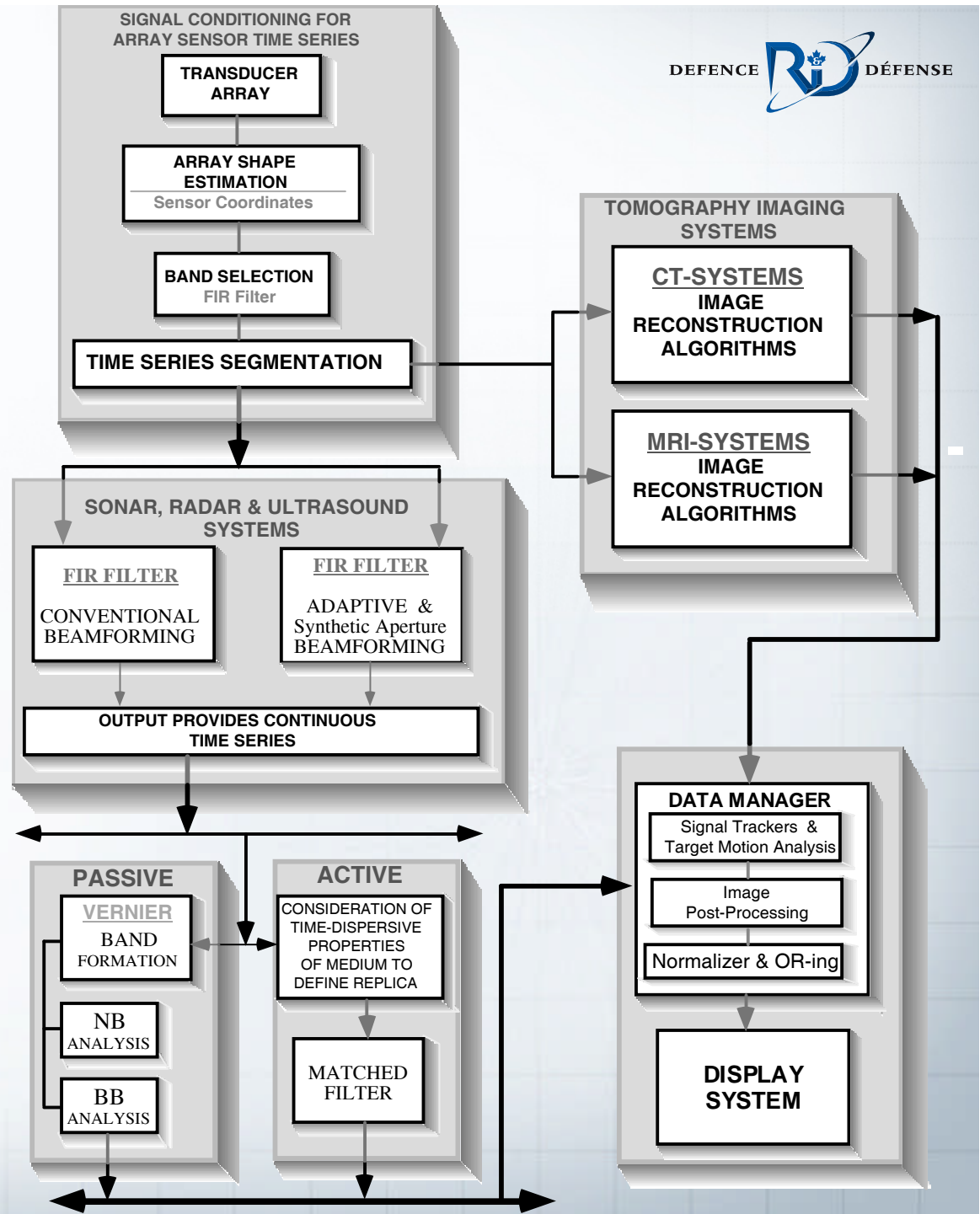

Tactical Picture Post-Processing (FUSION) for Sonar and Radar

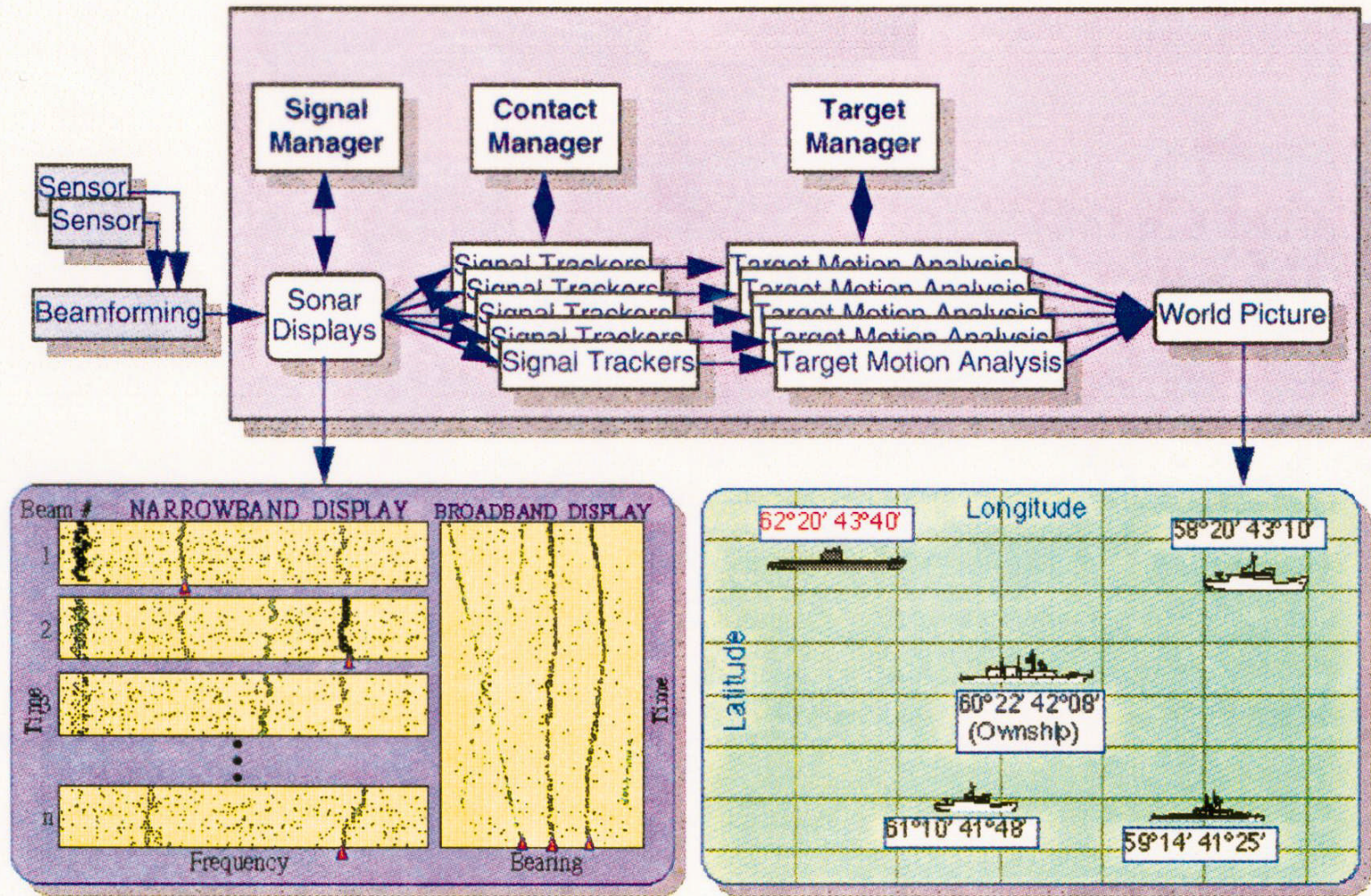

Advanced 3D Beamformers for Multi-Sensor Sonar Systems

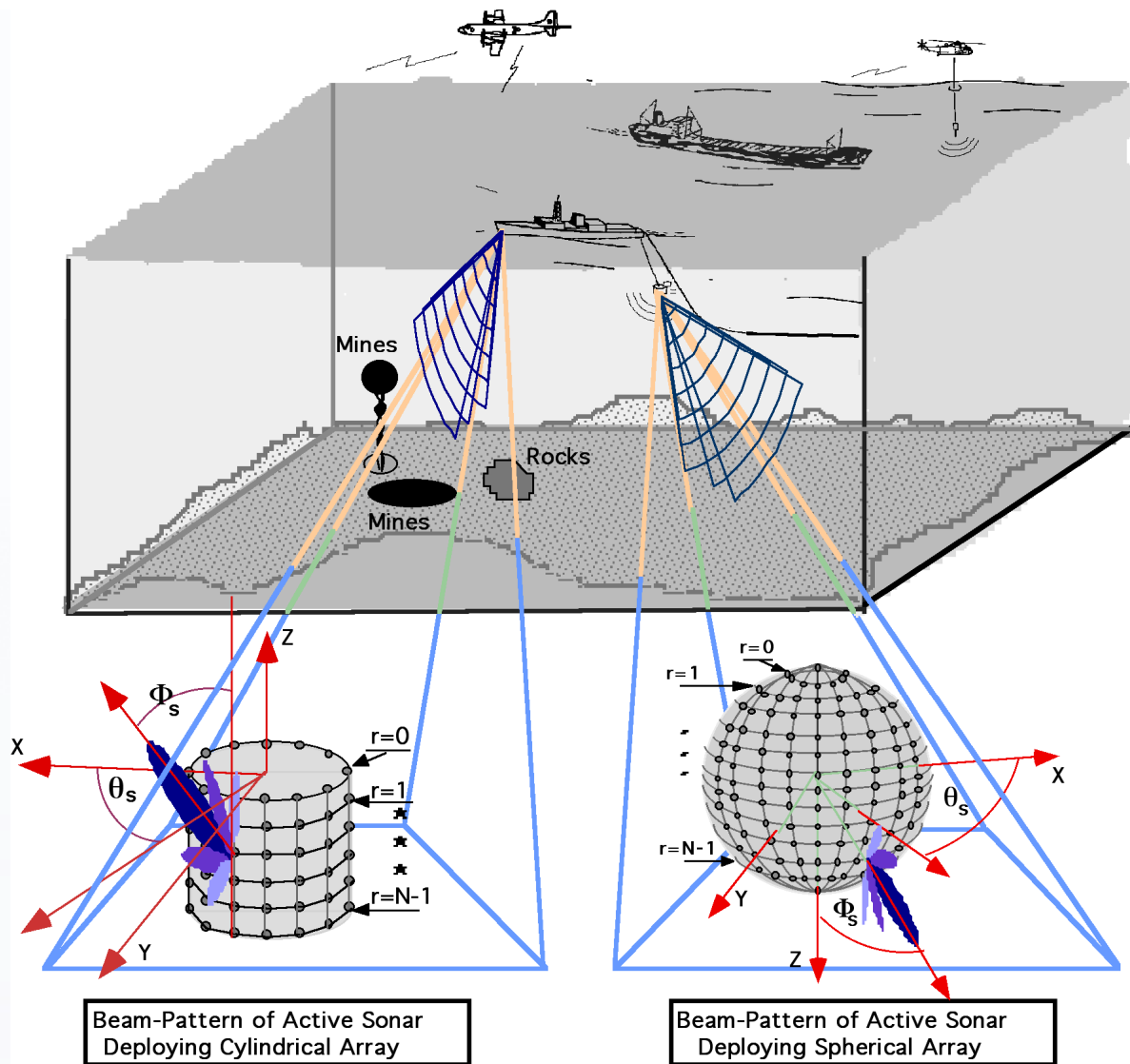

Figure 1

Adaptive Sup-Aperture Structure for Line Arrays

The line array is divided into a number of sub-arrays that overlap.

The sub-arrays are beamformed using the conventional approach; and this is the first stage of beamforming.

Then, we form a number of sets of beams with each set consisting of beams that are steered at the same direction but each one of them generated by a different sub-array.

A set of beams of this kind is equivalent to a line array that consists of directional sensors steered at the same direction, with sensor spacing equal to the space separation between two contiguous sub-arrays and with the number of sensors equal to the number of sub-arrays.

The second stage of beamforming implements an adaptive scheme on the above kind of set of beams, as illustrated in Figure.

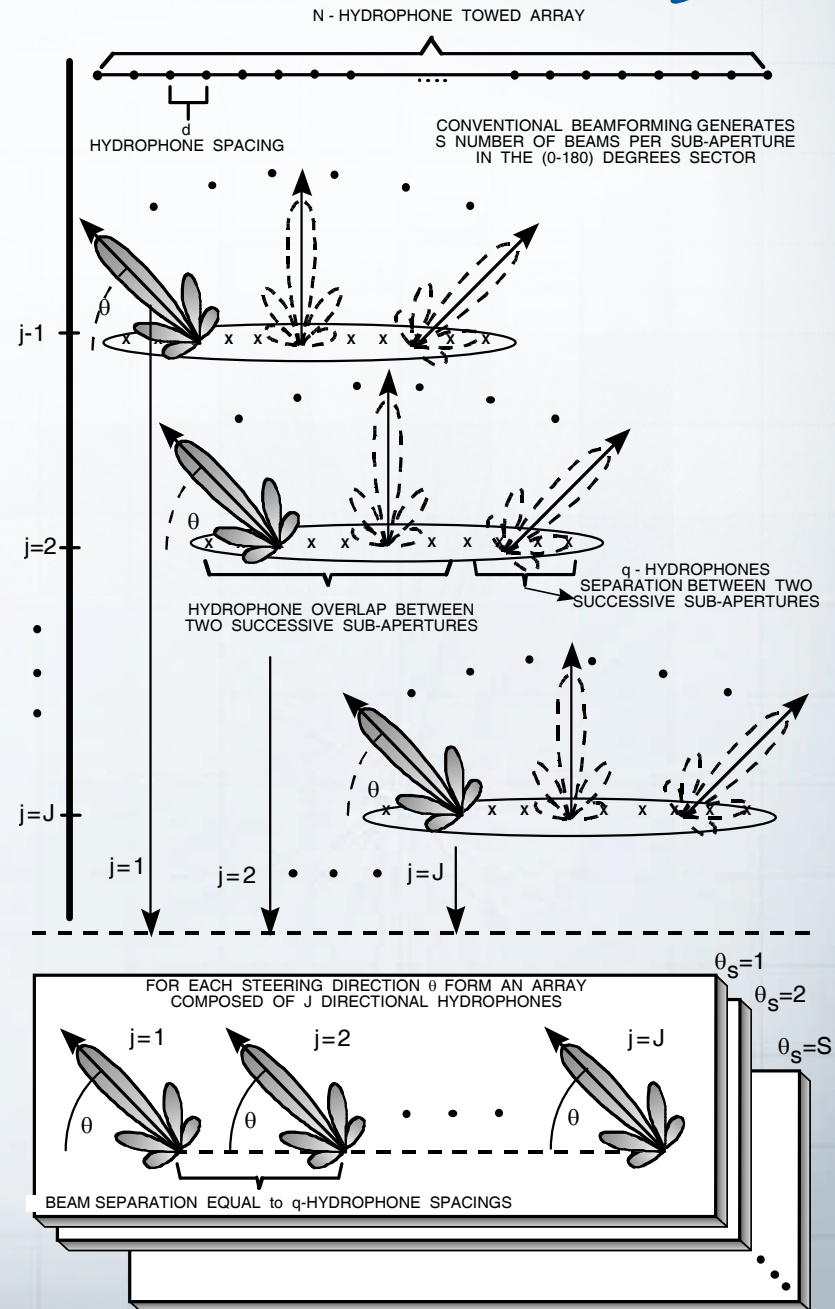

Sup-Aperture Structure for CiLindrical Arrays

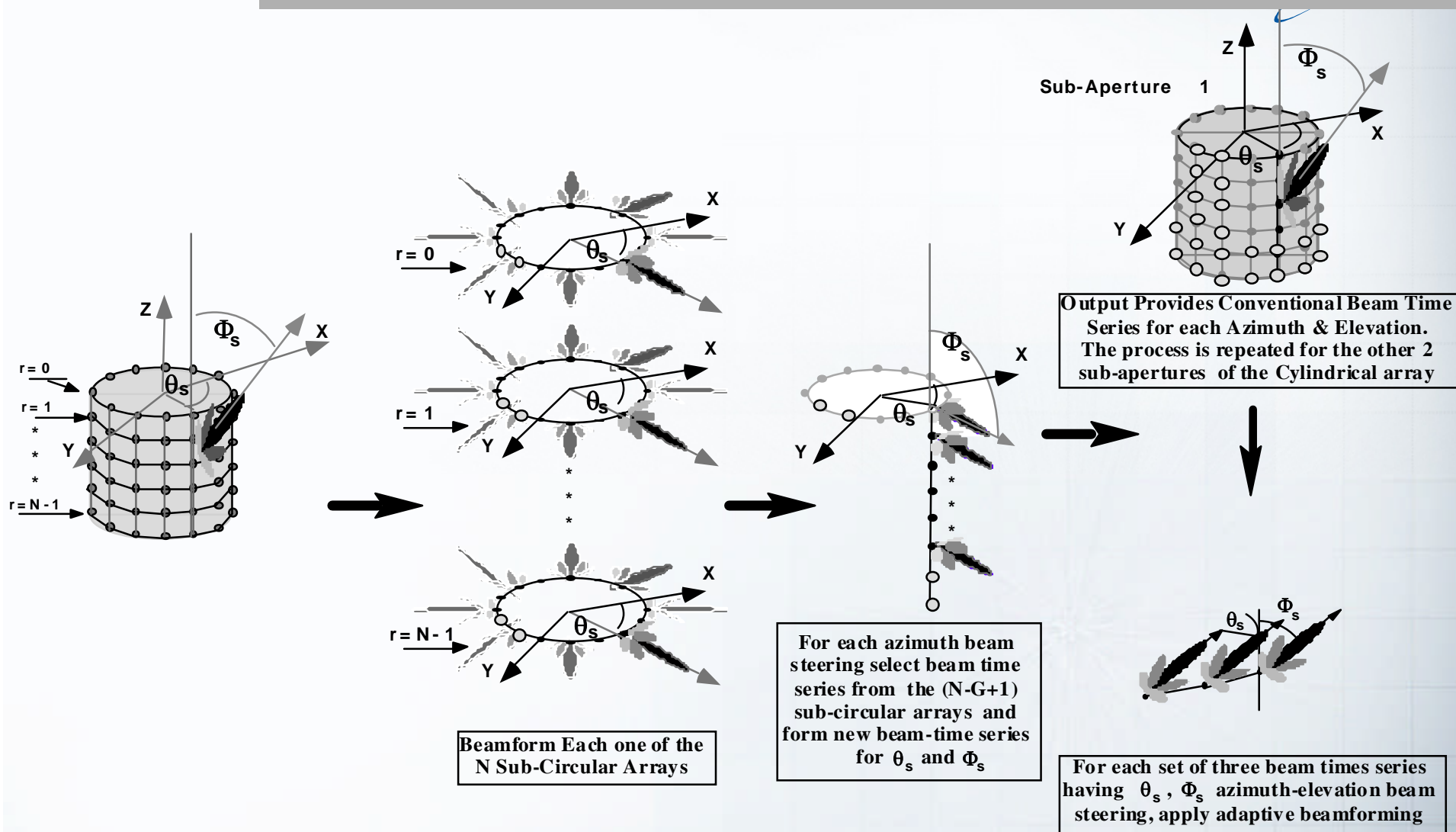

Stergiopoulos S. and Geoffrey Edelson, "Theory and Implementation of Advanced Signal processing for Active and Passive Sonar Systems", *Handbook on Advanced Signal Processing for Sonar, Radar and Medical Imaging Systems*, Editor: S. Stergiopoulos, CRC Press LLC, Boca Raton, FL, USA, March 2000.

Adaptive Processing for Sonar & Ultrasound Systems

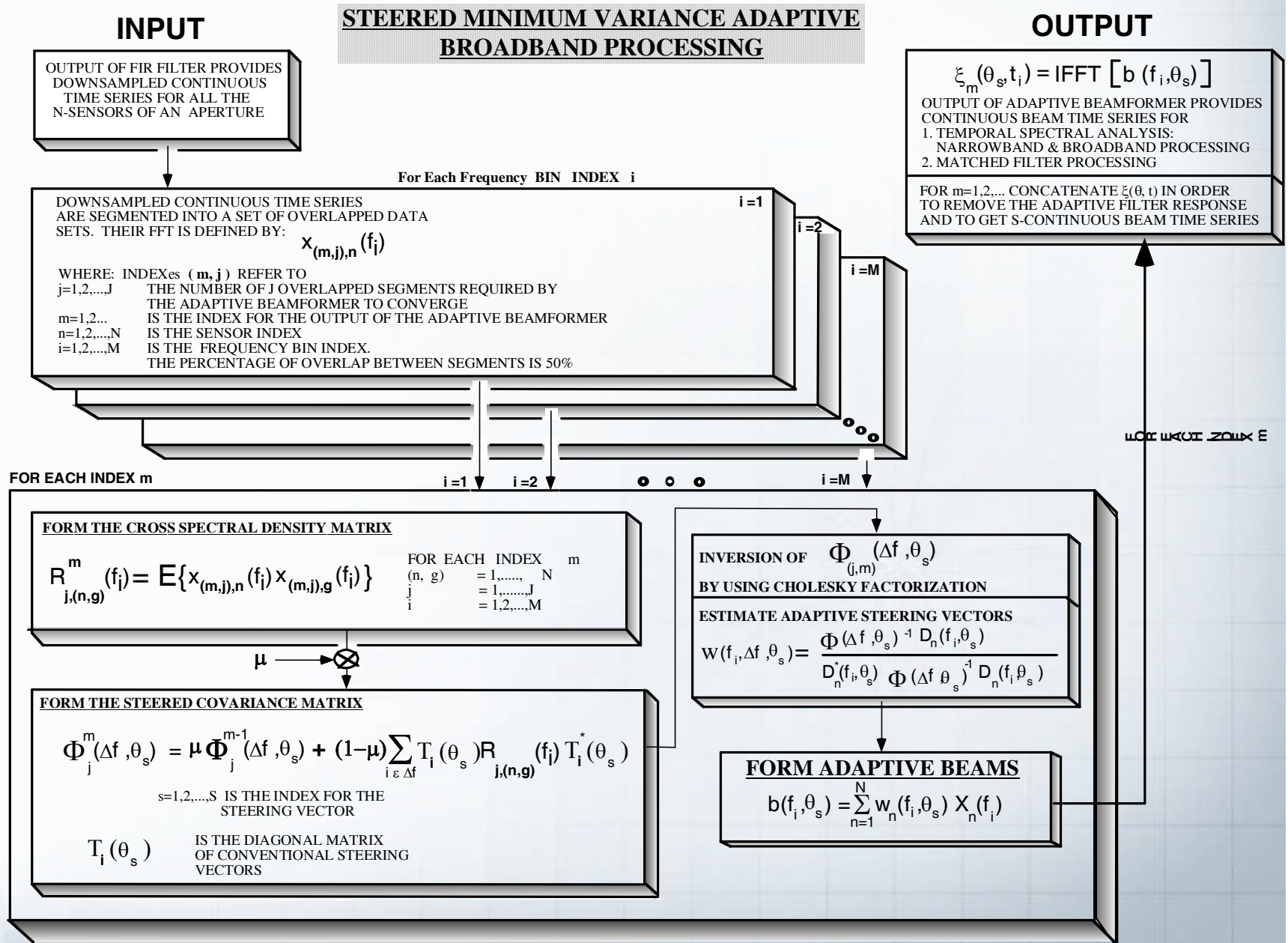

Stergiopoulos S., "Implementation of Adaptive and Synthetic Aperture Beamformers in Sonar Systems", The Proceedings of the IEEE , 86(2), 358-396, Feb. 1998.

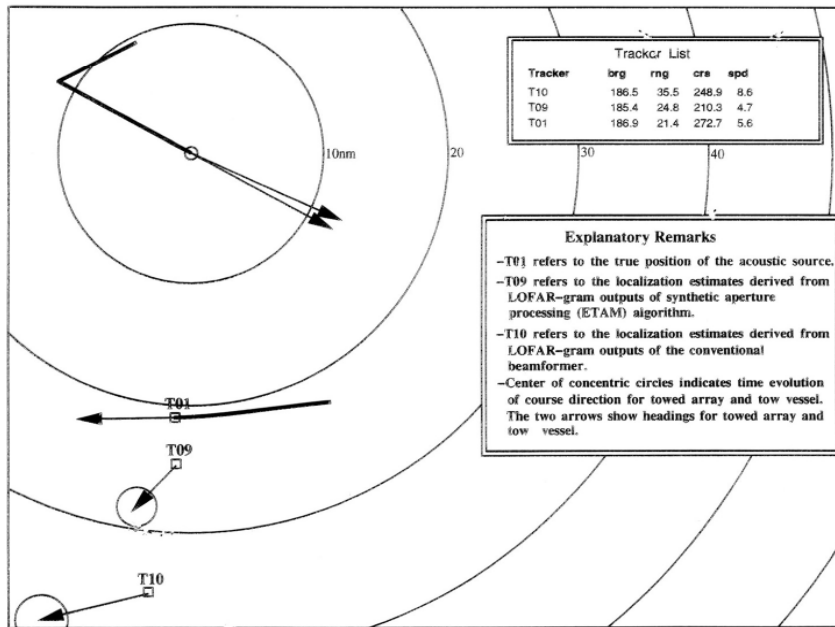
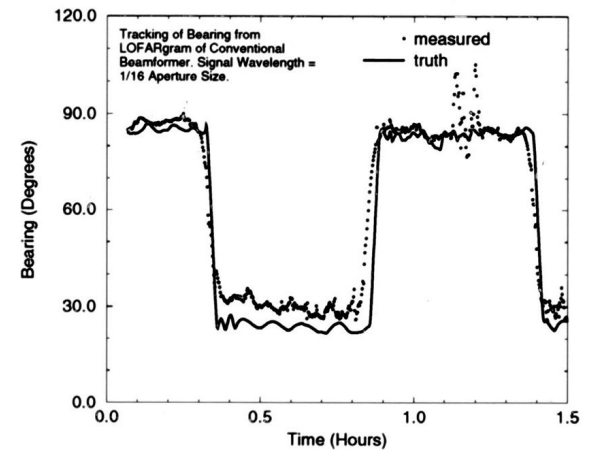
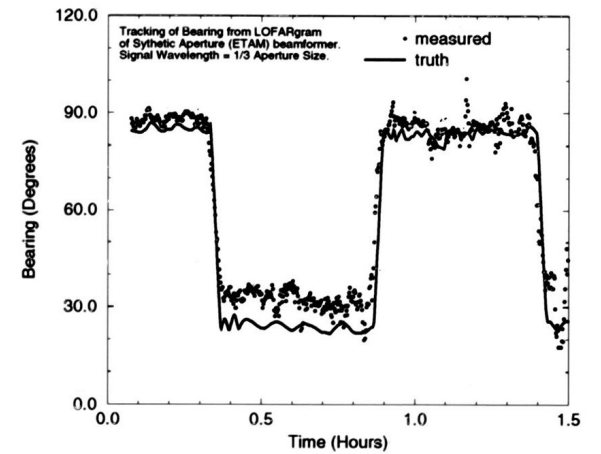
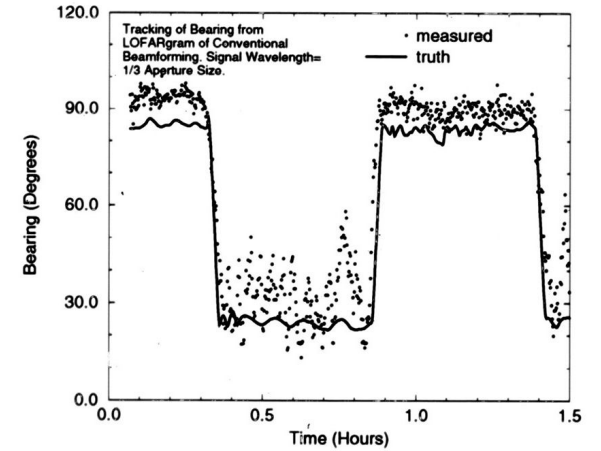
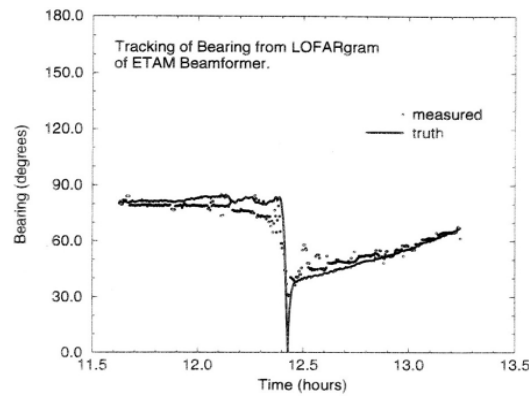
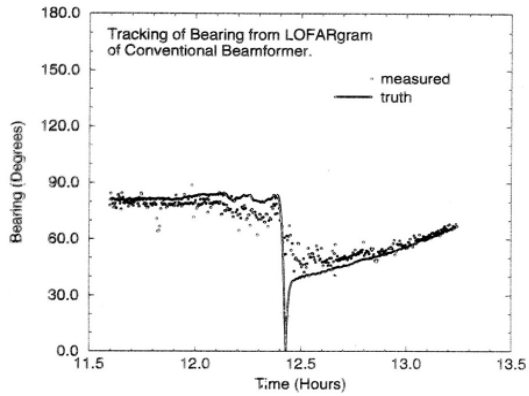

BB Case:
 Effectiveness of
 Adaptive Processing in
 Bearing Resolution
 and Signal Tracking

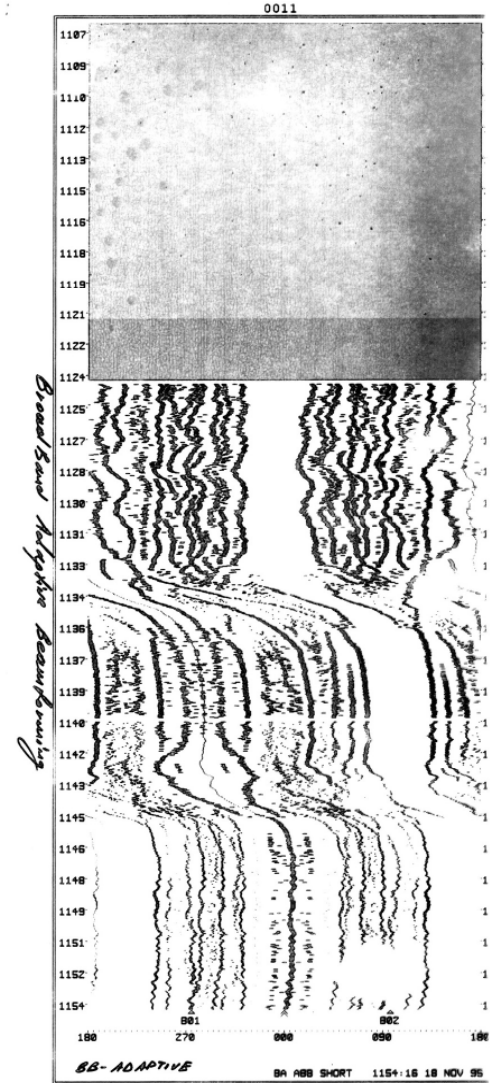
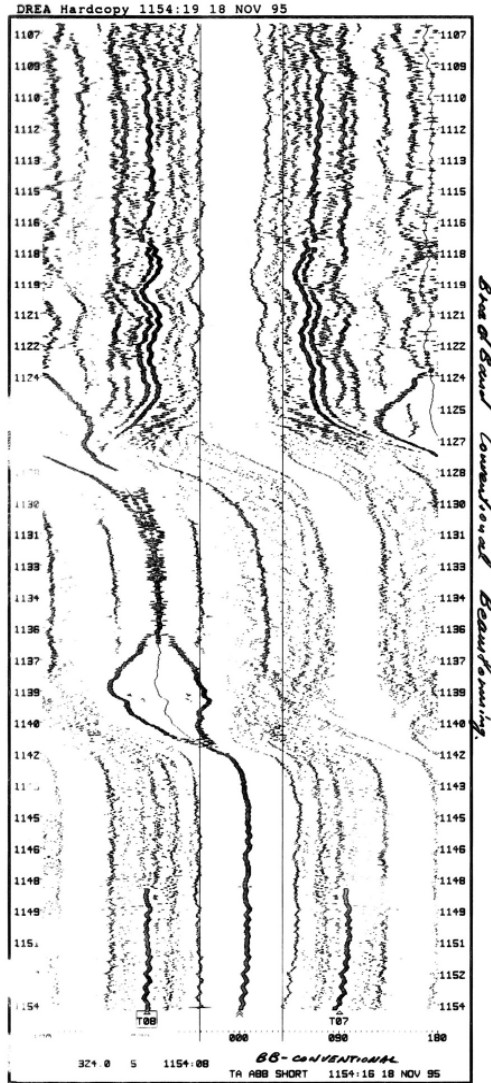

Acoustic Tomography for Detecting Land Mines



Younis W., Stergiopoulos S., Havelock, D., Groski J., "Non-Destructive Imaging of Shallow Buried Objects Using Acoustic Computed Tomography", J. Acoust. Soc. Am., 111(5), 2117-2127, 2002.

Acoustic Tomography for Detecting Land Mines

Sensors
1 - 32

Depth
↓



Gram for a single acoustic-sensor around 360-degrees

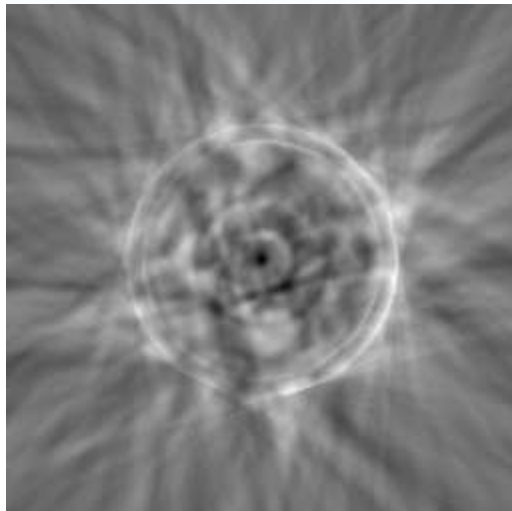
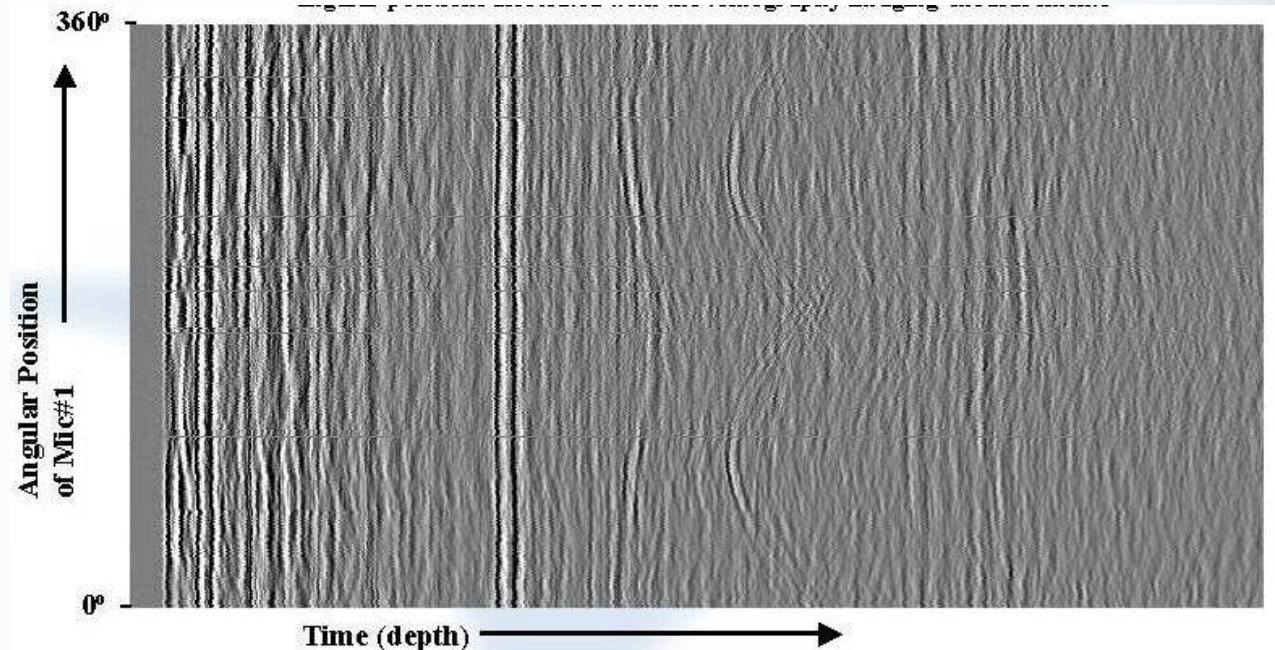

The Shepp-Logan

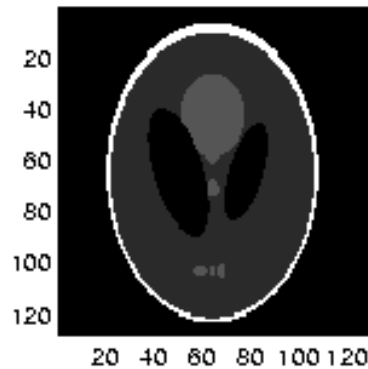

Interpolation level=32

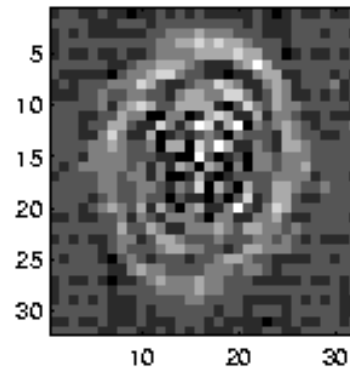

Interpolation level=256

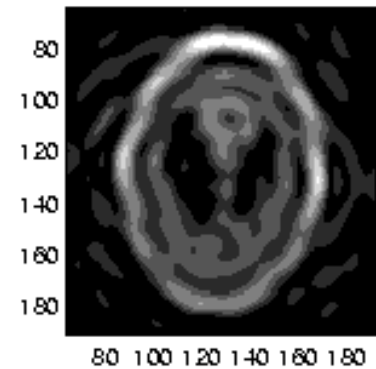
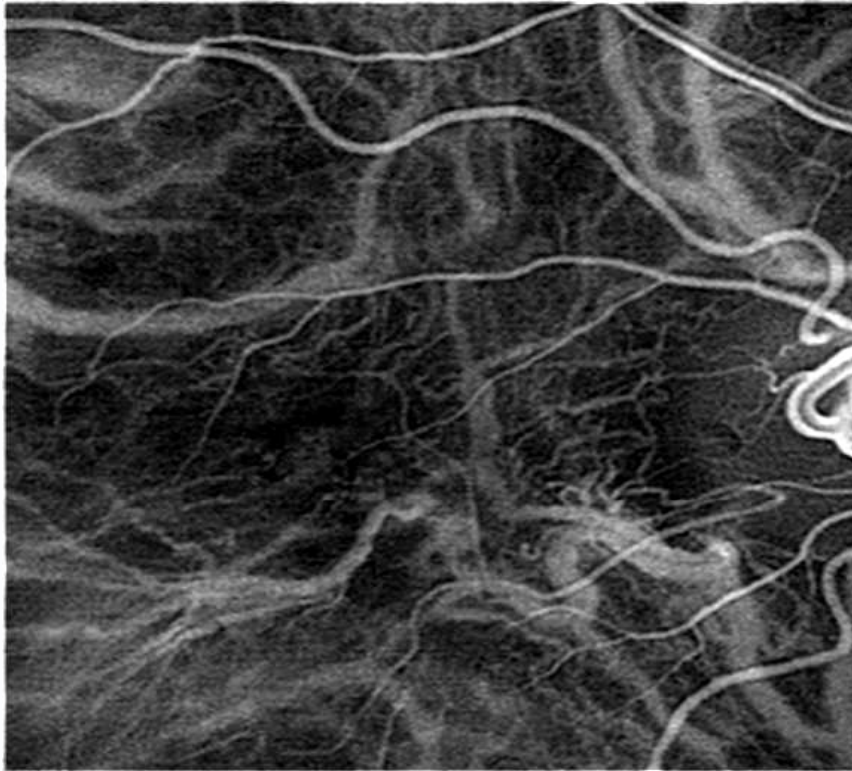
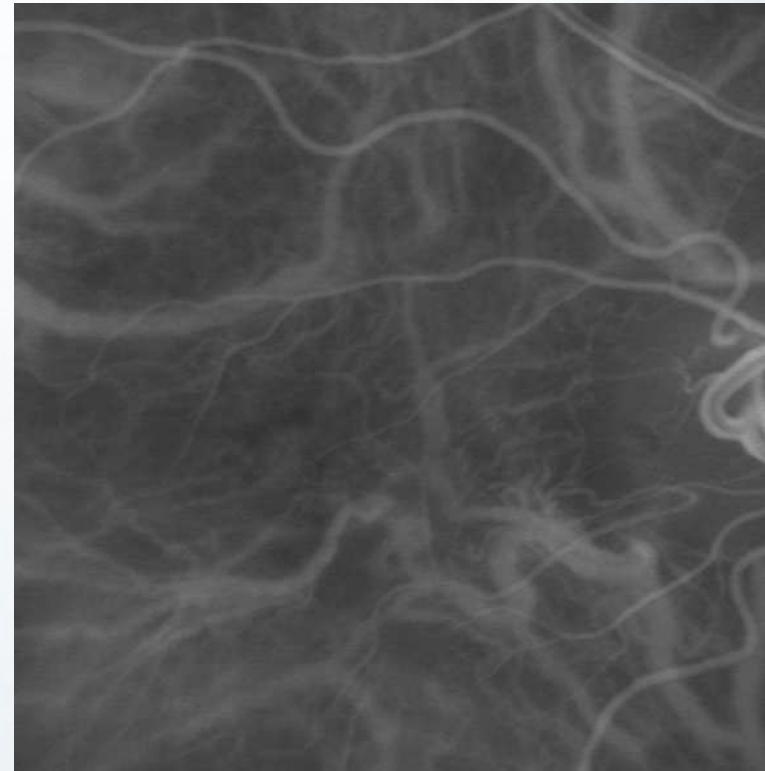

Image Enhancement Using Blind Deconvolution



**DRDC's Blind Deconvolution
Image processing Output for the Same Image**



NOVADAQ's Original Image

FOURIER Euro-Workshop Supported by EC-IST



- ❖ **Objective:** Technical exchange among world-wide leading experts on advanced signal processing. The end result of the Fourier EuroWorkshop was the preparation of a **Handbook on Advanced Signal Processing, Theory & Implementation for Sonar Radar and Medical Imaging Systems**. Publisher is CRC-Press with Editor Dr. Stergiopoulos.



FOURIER
EUROWORKSHOP ON ADVANCED SIGNAL PROCESSING
Theory & Implementation for Radar, Sonar
and Medical Imaging Systems

**HOTEL
CORFU
PALACE
CORFU
GREECE**

**10-13
APRIL
2000**

First Announcement and Call for Papers
Jointly Organised by :

- The European Commission
- The Institute of Communication and Computer Systems
- The National Technical University of Athens
- The University of Western Ontario, Canada

The Institute of Communication and Computer Systems
9, Iroon Polytechniou Str. Athens, 117 73 Greece
Tel. +30-1-7723556, Fax. +30-1-7723557
e-mail: gmats@esd.ece.ntua.gr / fourier

Point of contact and address for Correspondence

Electrical Engineering
THE ELECTRICAL ENGINEERING AND SIGNAL PROCESSING SERIES

ADVANCED SIGNAL PROCESSING HANDBOOK
Theory and Implementation for Radar, Sonar, and Medical Imaging Real Time Systems
Edited by STERGIOS STERGIOPOULOS

Advances in digital signal processing algorithms and computer technology have combined to produce real-time systems with capabilities far beyond those of just a few years ago. Nonlinear, adaptive methods for signal processing have emerged to provide better array gain performance, however, they lack the robustness of conventional algorithms. The challenge remains to develop a concept that exploits the advantage of both schemes that integrates those methods in practical, real-time systems.

The *Advanced Signal Processing Handbook* helps you meet that challenge. Beyond offering an outstanding introduction to the principles and applications of advanced signal processing, it develops a generic processing structure that takes advantage of the similarities that exist among radar, sonar, and medical imaging systems and integrates conventional and nonlinear processing schemes. The Handbook also:

- Summarizes the state-of-the-art application of advanced processing concepts in sonar, radar, and medical imaging and points out their applicability, benefits, and potential
- Disseminates the results of research funded by government and military agencies
- Develops a generic concept for implementing adaptive, synthetic aperture processing schemes
- Illustrates concepts, techniques, and applications with more than 400 figures, photographs, and images
- Bridges a variety of related fields to provide a comprehensive reference for current and emerging applications

The *Advanced Signal Processing Handbook* presents the most recent theoretical developments in signal and image processing. More than 32 international experts identify applications and assess the impact and improvements of advanced processing techniques in sonar systems, medical imaging systems, and industrial applications of CT and ultrasound imaging systems. They show how modern technology can be applied to development of current systems and guide you into the next generation active and passive real-time systems.

STERGIOPOULOS
ADVANCED SIGNAL PROCESSING HANDBOOK

ADVANCED SIGNAL PROCESSING HANDBOOK
Theory and Implementation for Radar, Sonar, and Medical Imaging Real Time Systems
Edited by STERGIOS STERGIOPOULOS

3693
ISSN 0-8493-3693-0
9 780849 369300

CRC

EC-IST Funding



EC-Esprit #26764-New Roentgen

Total funding: Euro 1.5 million, 1998-2000, Project: Cardiac X-ray CT, Partners: Fraunhofer, Siemens, SEMA Group, DRDC

EC-IST-1999-10618 MITTUG, Project: Ultrasound Technology for Brachytherapy applications

Total funding: Euro 2.2 million, 2000-2003, Partners: Fraunhofer, Nucletron, DRDC-Toronto, University of Western Ontario(LHRI)

EC-IST-2000-28168 MRI-MARCB, Project: Cardiac Motion Correction for MRI imaging diagnostic

Total funding: Euro 1.5 million, 2001-2004, Partners: Fraunhofer, Philips, DRDC-Toronto, University of Western Ontario(LHRI)

EC-IST-2001-34088 ADUMS, Project: Fully Digital portable 3D Ultrasound Technology

Total funding: Euro 2.0 million, 2002-2005, Partners: Fraunhofer, ESAOTE, ATMEL, CANAMET, University of Toronto

EC-IST-2002, DUST, Project: Identification of Dual-Use Military Technologies

Total funding: Euro 0.75 million, 2002-2003, Partners: Defence European Labs from Netherlands, UK, Denmark, Canada DRDC

Euro-Conference: FOURIER Project: Euro-Conference on Dual-Use Technologies

Total funding: Euro 100,000, April-2000, Corfu, Greece

Partners: World-Wide Experts from Defence and Industrial Labs from North America and EU States.

The Problem for Cardiac x-ray CT



Organ motion Artifacts!

Data acquired in a time sequential manner

There is motion by patient: *Restlessness*, *Cardiac motion*, *Respiratory motion*

Scanning leads to ambiguous data, and blurry or meaningless images

Difficult to interpret

Possibility of Inaccurate Diagnosis!!!

The Spatial Overlap Correlator for x-ray CT

Spatially overlapping
detectors sampling object with
Source #2 at time $t = t_0$ and
Source #1 at time $t = t_0 + \delta$

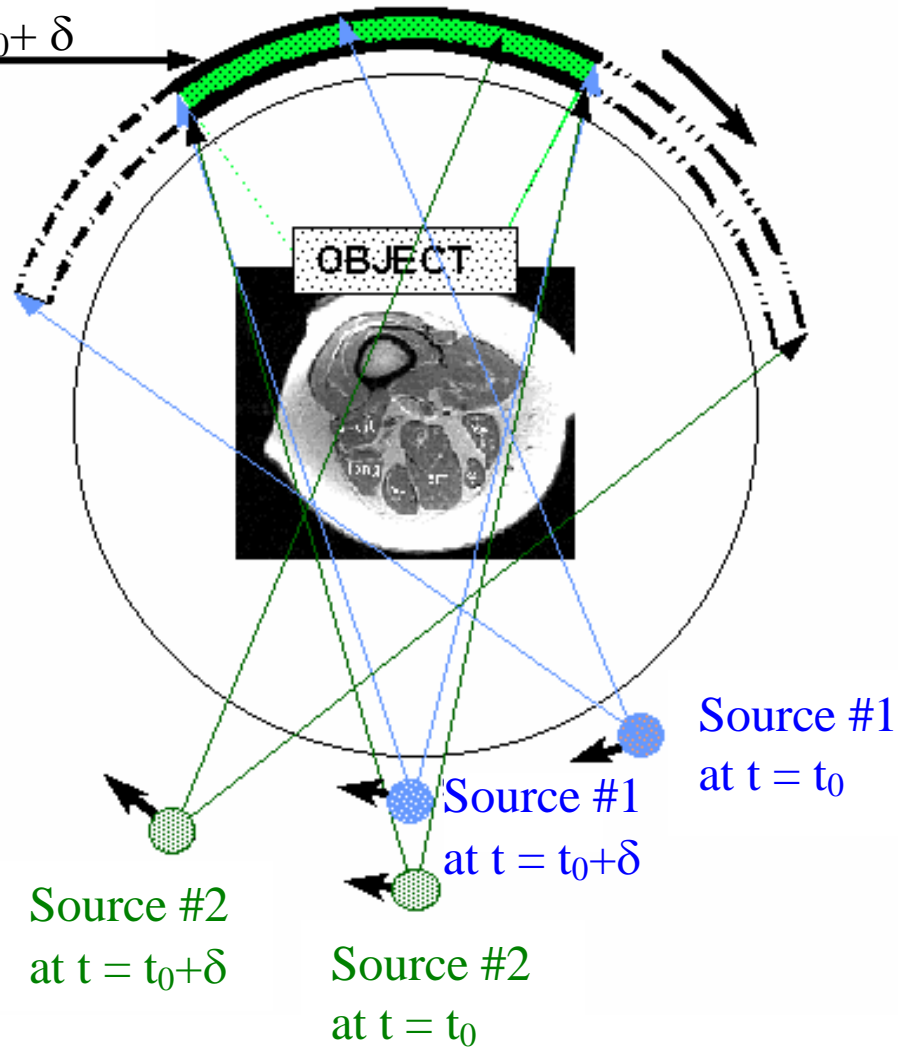

Outputs from SOC

Original

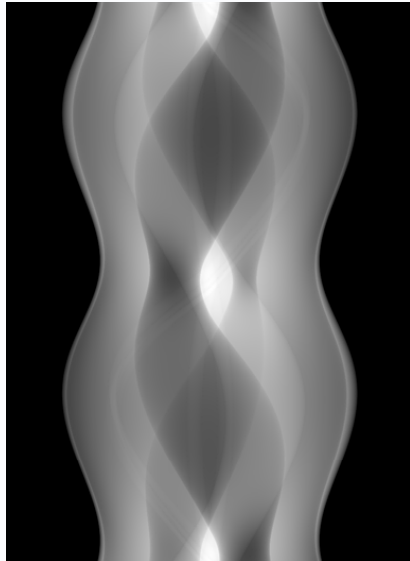

SOC Measurement

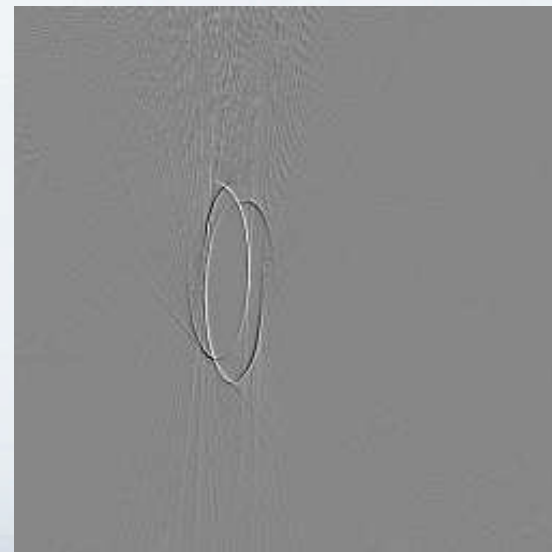
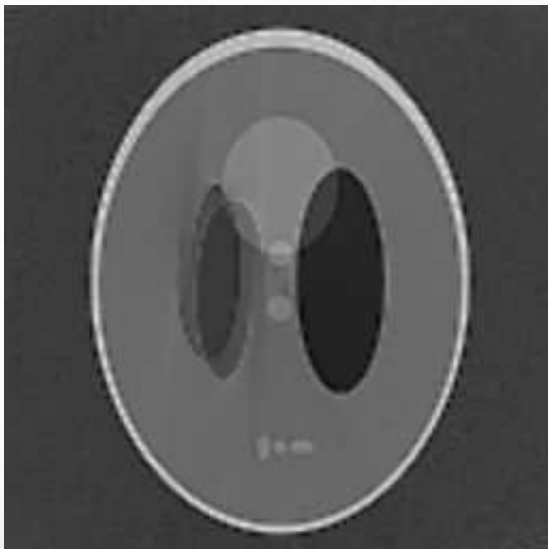

Experiments with Moving Phantom

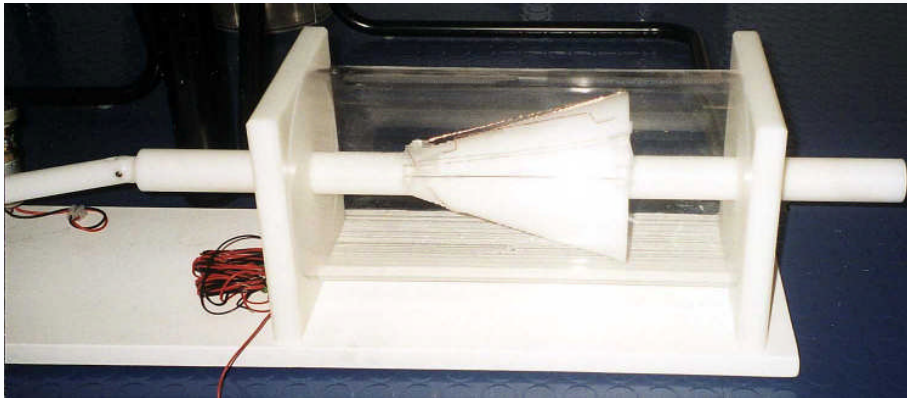

Experiments with Moving Phantom

Period of Motion = 0.6s

Conventional

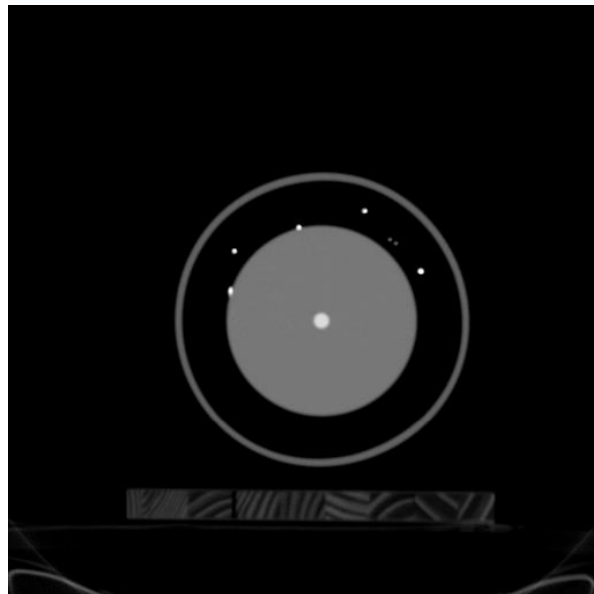

Corrected

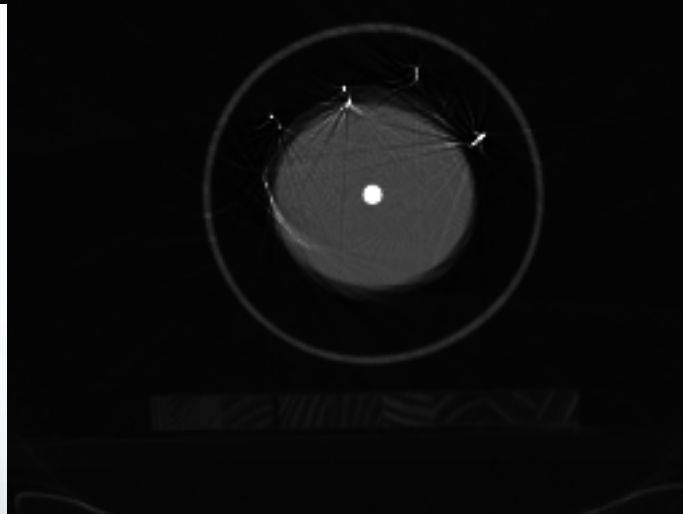
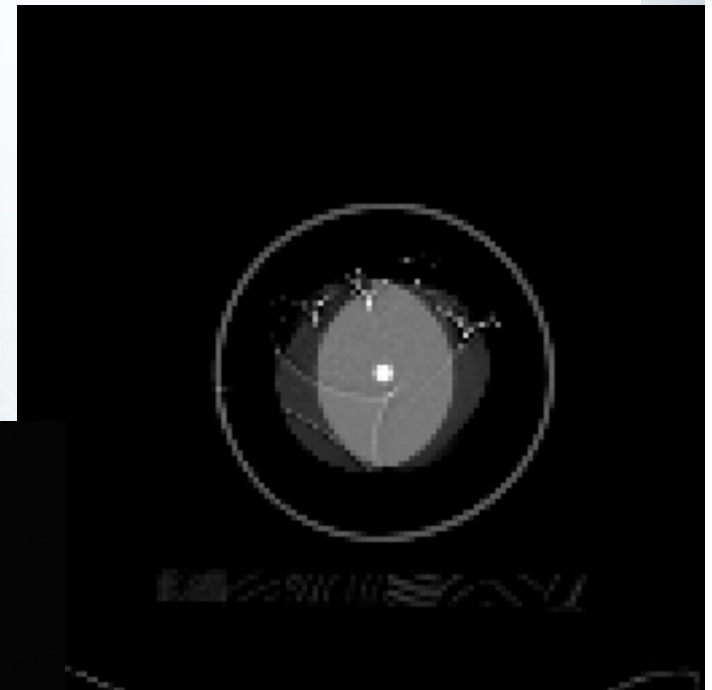

Clinical Trials

Cardiac Motion Correction Results

Motion artefacts present
(calcification not visible)

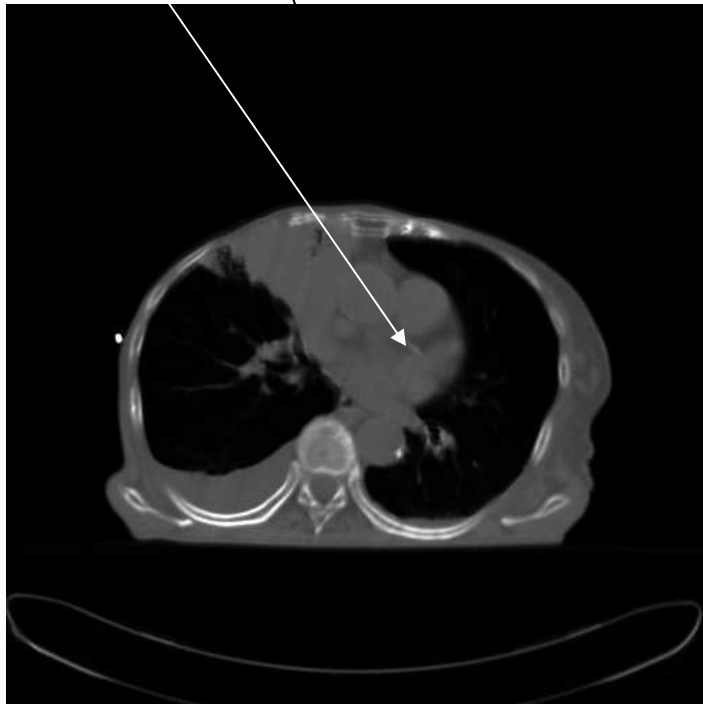

Motion artefacts removed
(calcification visible)

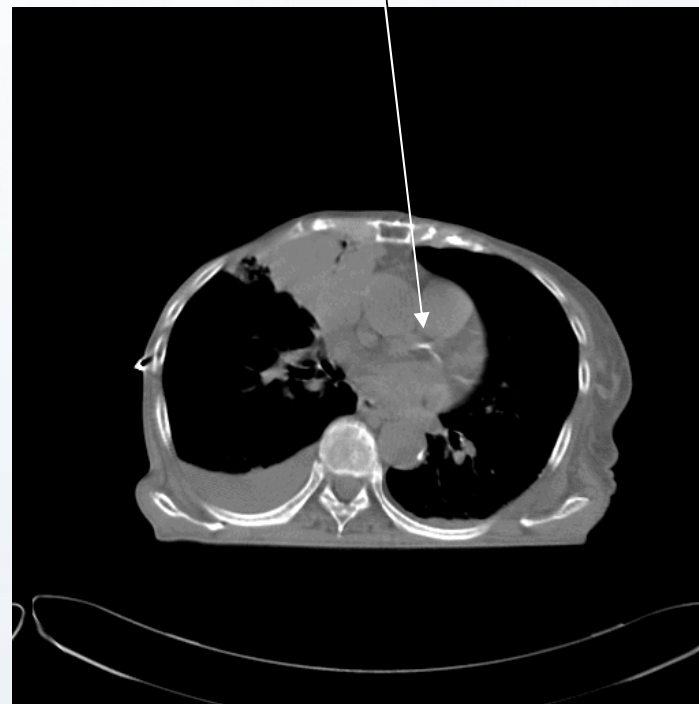

Cardiac Motion Correction Package



Analysis of Calcium Scoring in Calcification Mode

Recommended Images
Recommended Image One
Recommended Image Two
Recommended Image Three

Current Image: ----

Adjusting Control
Level Control: 1092
Window Control: 1796

User Options
Modes
Tools

Display
Pos X: 311
Pos Y: 246
Zoom %: ----
Area: ----
Length: ----
Calcium Scoring: 2970
Calcium Ratio: 72 %
Pixel Value: 2709

Saved Images
Figure 1
Level: -1000
Window: 1491
Figure 2
Level: 194
Window: 2152
Figure 3
Level: -496
Window: 988
Figure 4

Applicable for Multi-Slice CT Scanners



Single Slice CT

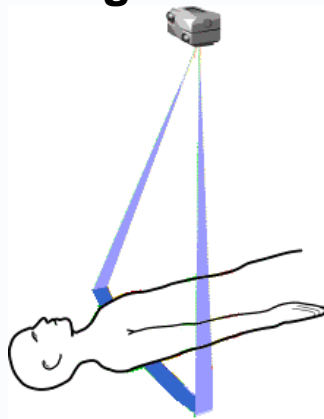

A total of six rotations of data (shown with thick lines) are used for the given cross-section. This data was spread from $-\Delta z$ to Δz around the cross-section

1. The 360-degree interpolation produced three rotation data for the selected cross-section.
2. This interpolated data is used by *motion phase identification algorithm* to detect the diastole phase of the cardiac cycle.
3. Finally, a 'clean' (180 +fan) data will be used for image reconstruction.

Multi Slice CT

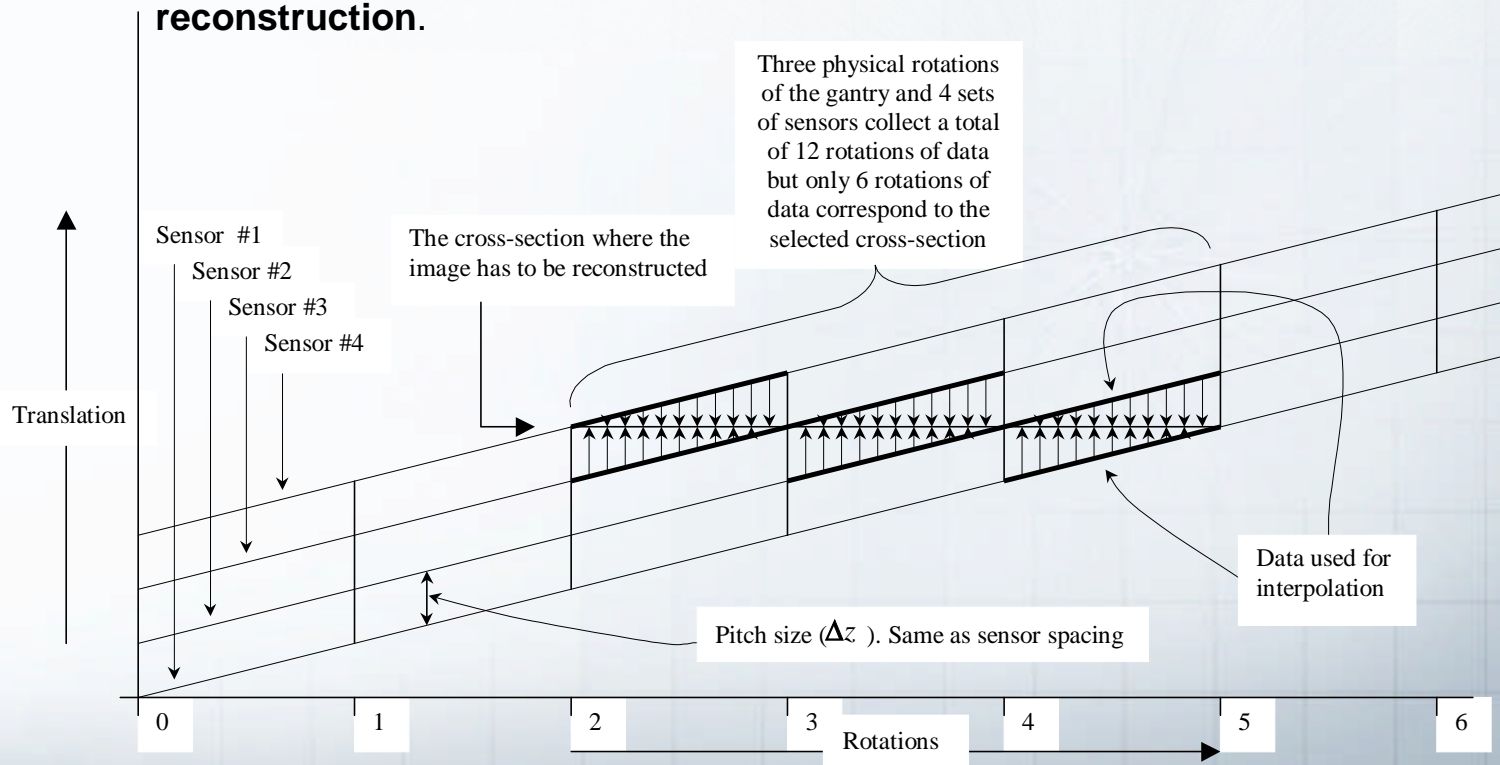
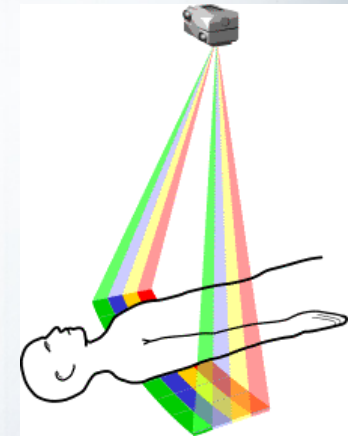

Applicable for Multi-Slice CT Scanners

Reconstructed 2D Images from a 3D Phantom using a Multi-Slice CT

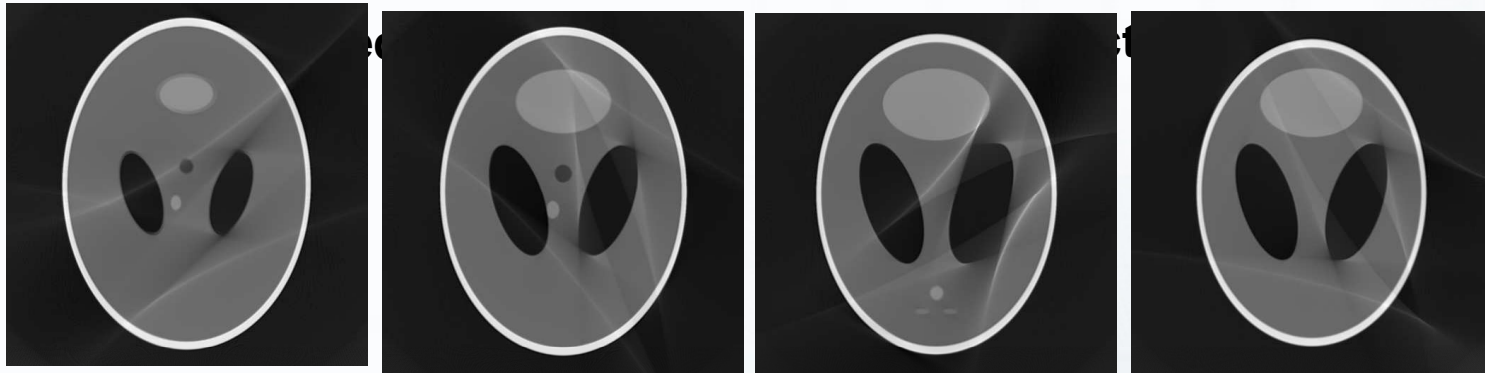

Correction of above 2D Images using DRDC's Software

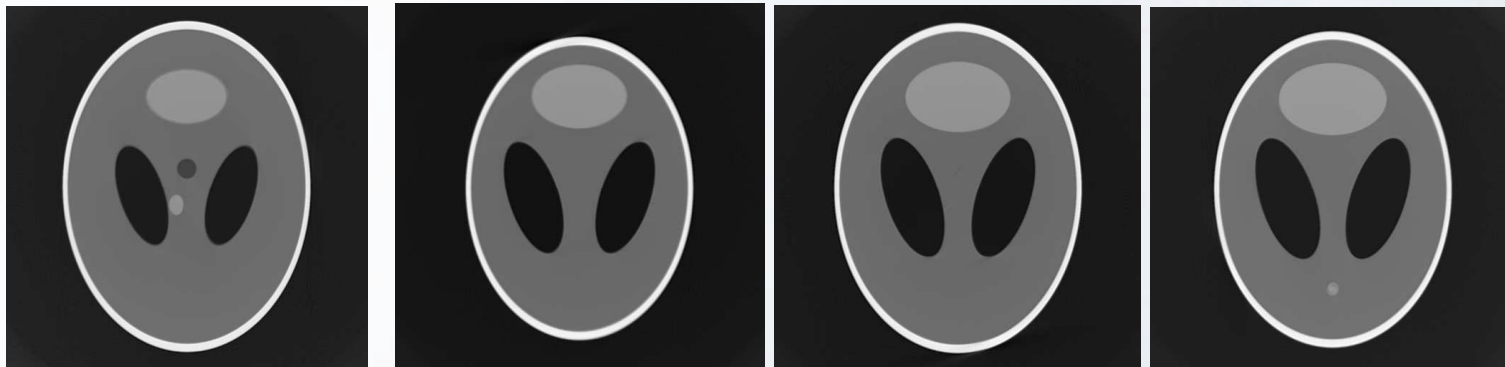

Motion Correction for MRI Brain Imaging Diagnostic Applications

Figure 9: Final prototype of low-cost tracking system



Benefits

- **For the patient**
 - better diagnosis for restless patients
 - increased comfort / less claustrophobia
- **For the hospital/health system**
 - increased profitability of the MRI system as a result of increased patient throughput.
- **For the operator**
 - less effort to immobilize patient
 - less repetitions due to failed exams

Figure 10: Brain spin-echo images in the presence of strong subject motion without correction (left) and with correction (right).

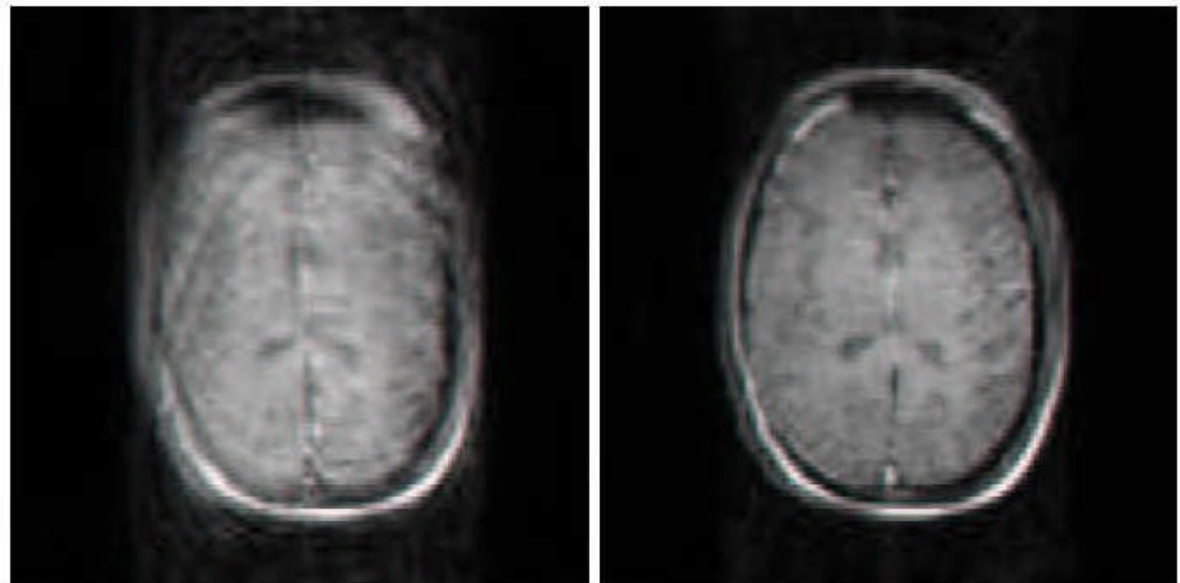

Motion Correction for MRI cardiac Imaging Diagnostic Applications

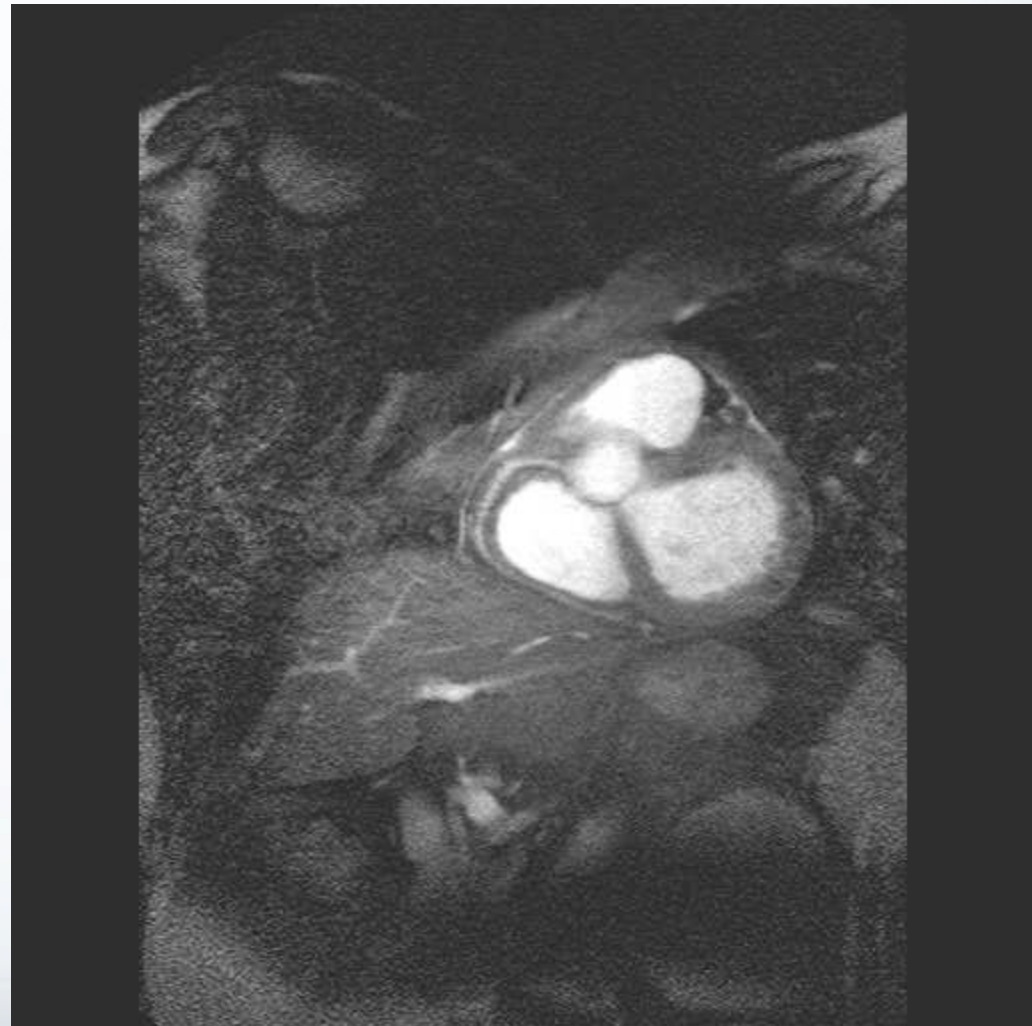
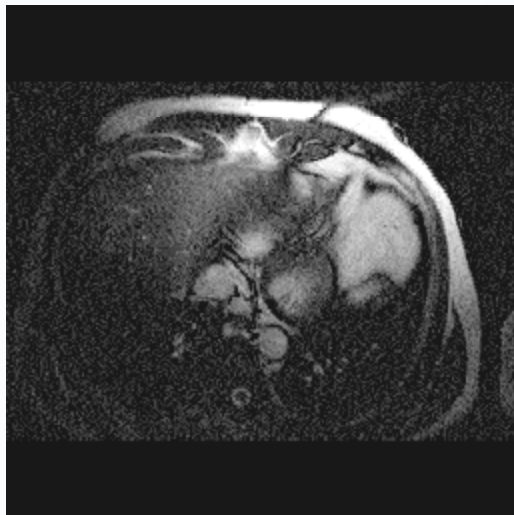

Technology Demonstration Project

Portable 3D/4D Ultrasound Diagnostic Imaging System

Overall Objective & Expected Outcome

To demonstrate the application of a proprietary DRDC technology for the development of a *compact, field-deployable, real-time, 3D* ultrasound imaging capability for Canada and our allies in:

- providing rapid diagnosis of nonvisible internal injury; and
- facilitating the implementation of life-saving medical interventions on the battlefield and in far-forward positions



Portable 3D/4D Ultrasound Diagnostic Imaging System

This project aims to:

- Demonstrate an advanced 4D (3D-Spatial + 1D-Temporal) ultrasound imaging system for non-invasive internal injury detection, especially:
 - pneumothorax
 - free fluid in abdomen
 - foreign objects
- Key concepts:
 - 3D real-time volume rendering
 - Advanced ultrasound transducer
 - High-speed, parallel data processing
 - Adaptive image reconstruction
 - Telemedicine
 - Automated Computer-assisted diagnosis

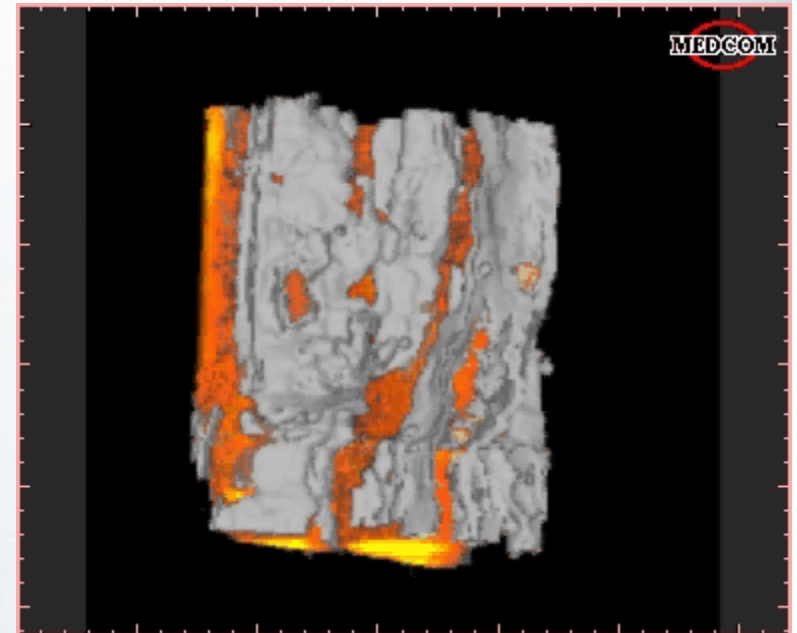

Advantages of Real-time 3D/4D vs 2D Ultrasound Imaging

- Minimal requirement for expert radiologist to diagnose injuries and abnormalities
- Better description of the relative locations of injuries and structures
- More accurate visualization during operations

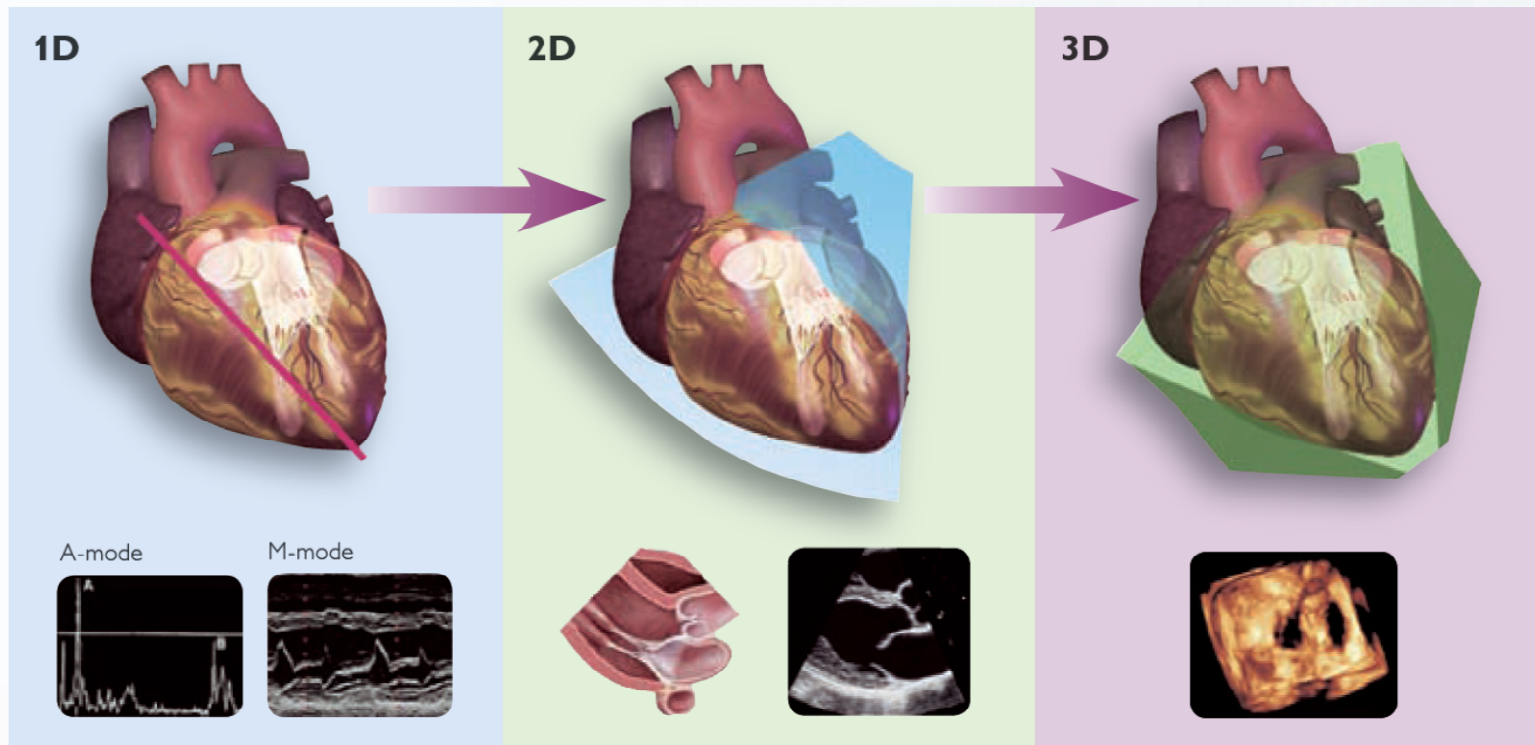

Figure adopted from article “Why Live 3D Echo” by Terry Hayes from Philips Healthcare website, <http://www.healthcare.philips.com>

Advantages of Real-time 3D/4D vs 2D Ultrasound Imaging



A 4D (real-time 3D) ultrasound system can acquire and display 3D volumetric images in real-time

However, Radiologists consider the conventional 2D ultrasound imaging as the traditional approach for establishing diagnosis; which requires intense training because it is a challenging task that may lead to miss-interpretations and errors. This challenge in diagnostic applications can be addressed with computer-aided diagnosis.

It has been assessed that the advantage of 3D or 4D U/S imaging, compared to 2D U/S imaging, consists of its capability to offer higher number of degrees of freedom and thus, can address requirements for training a decision support system for computer-aided diagnostic applications.

In summary, the real advantage of 4D versus 3D imaging is its potential to facilitate automated computer-aided diagnosis and this can be the only opportunity for 4D imaging to be used by Radiologists in clinical procedures. Currently, 3D/4D ultrasound is used only in gynaecological applications for 3D imaging of fetus.

Key Concept of DRDC Ultrasound Technology

Phase Planar Array Illumination

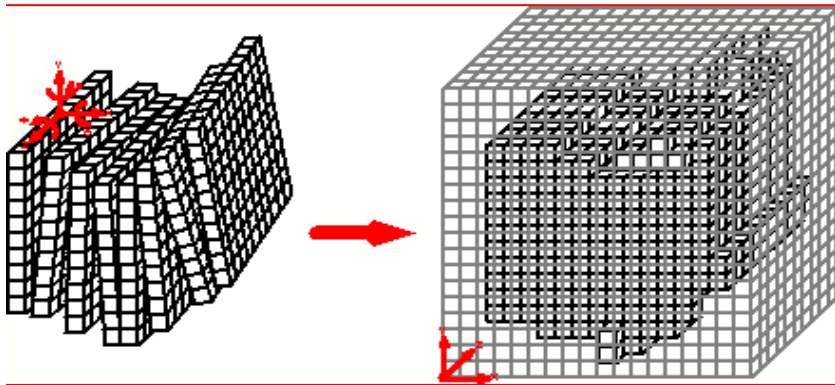

Available 3D Ultrasound Systems

- Converting 2D B-scan images into 3D through volume rendering

DRDC 3D Ultrasound System

- Using a planar array of *Sensors* (for ultrasound or GPR applications) and *Beamformers* to obtain complete data acquisition for 3D Image reconstruction

- 3D volume reconstructed from one position: no manual scanning
- Volume reconstructed with adaptive algorithm for better resolution
- Multi-focus capability with single illumination

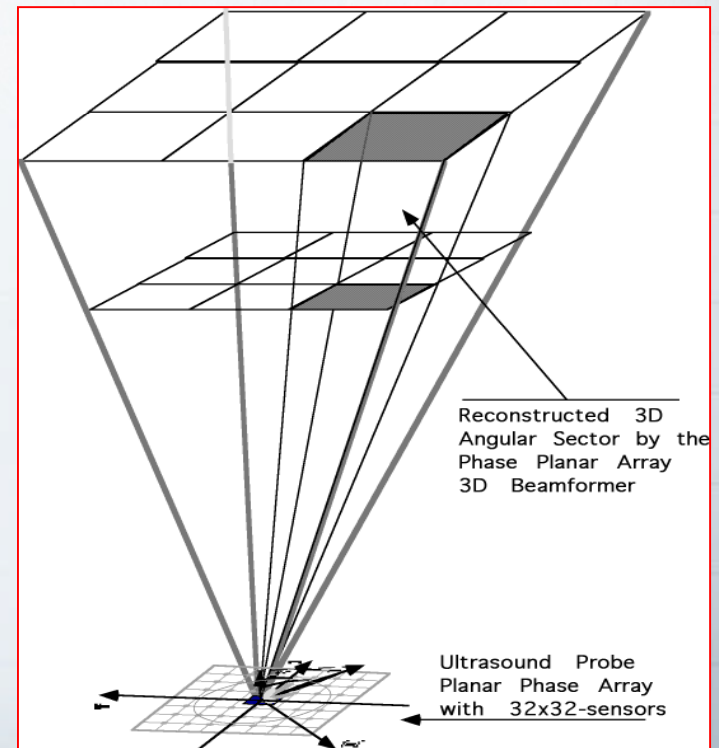

Inherent Limitations of Current Technology: Ultrasound Probe

- Better image resolution provided by higher frequency ultrasound
 - Cannot be higher than 3.0 MHz because of technological difficulties cutting the piezoelectric crystals.
- At fixed frequency, better image resolution from having more elements:
 - High hardware complexity and cost

DRDC's Proposed Solution

- Smaller array + proprietary 3D adaptive beamforming technology
- Improved angular image resolution and array gains by a factor of 4.
- Thus, **the deployed 32x32 array** will have an improved resolution and array gain **equivalent to a 64x64 array**.

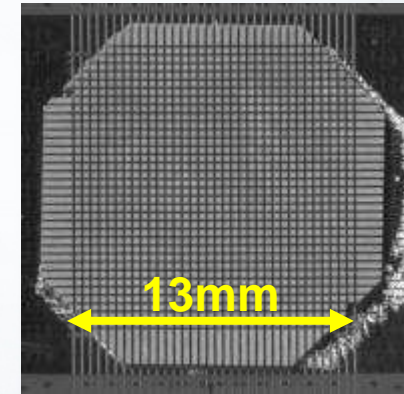
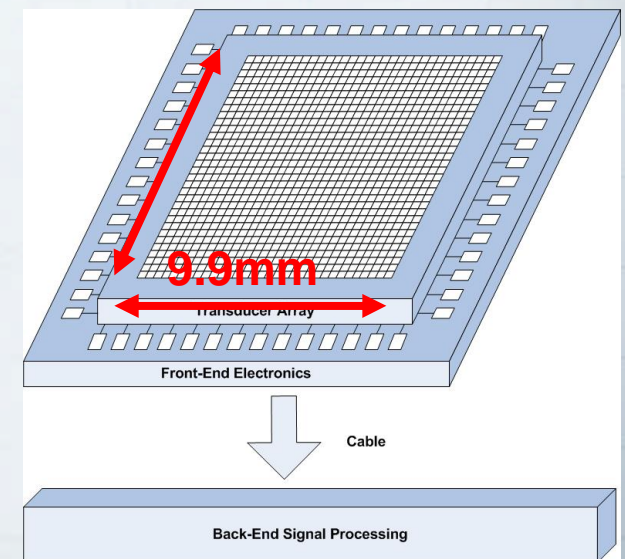
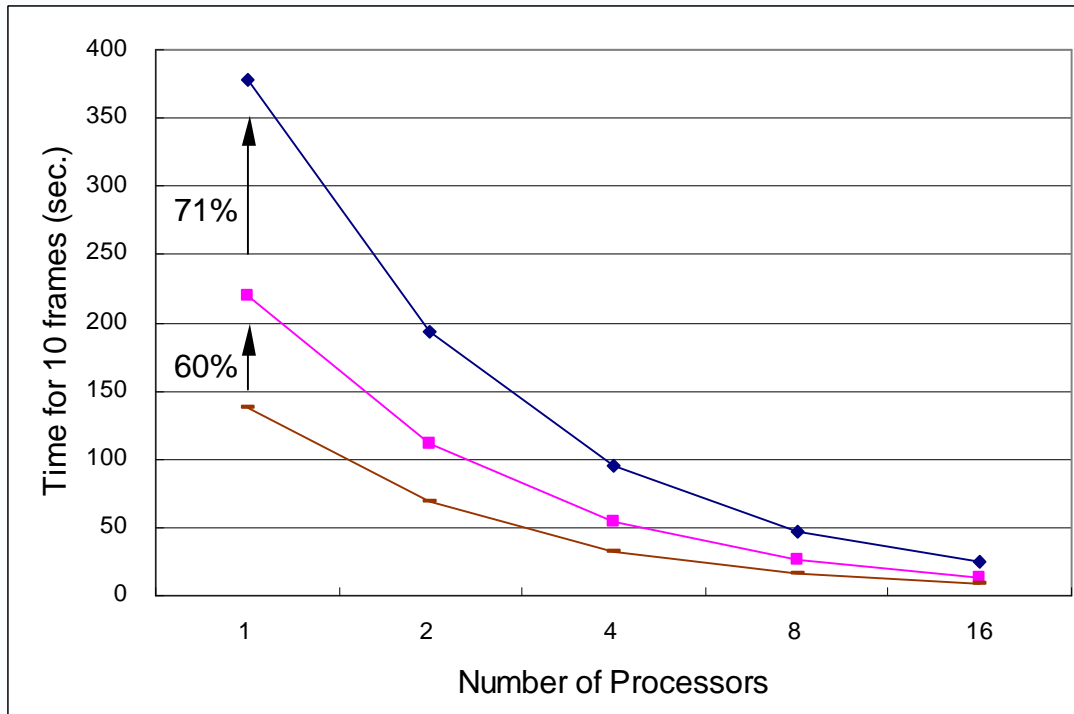

Image of a 36x36 elements planar array transducer developed at Duke University



PUDIS planar array transducer design with 32x32 elements

Highly Parallelized Signal Processing



Execution time scales linearly with the number of processors

Important parameters for performance

FFT size

Number of sensors

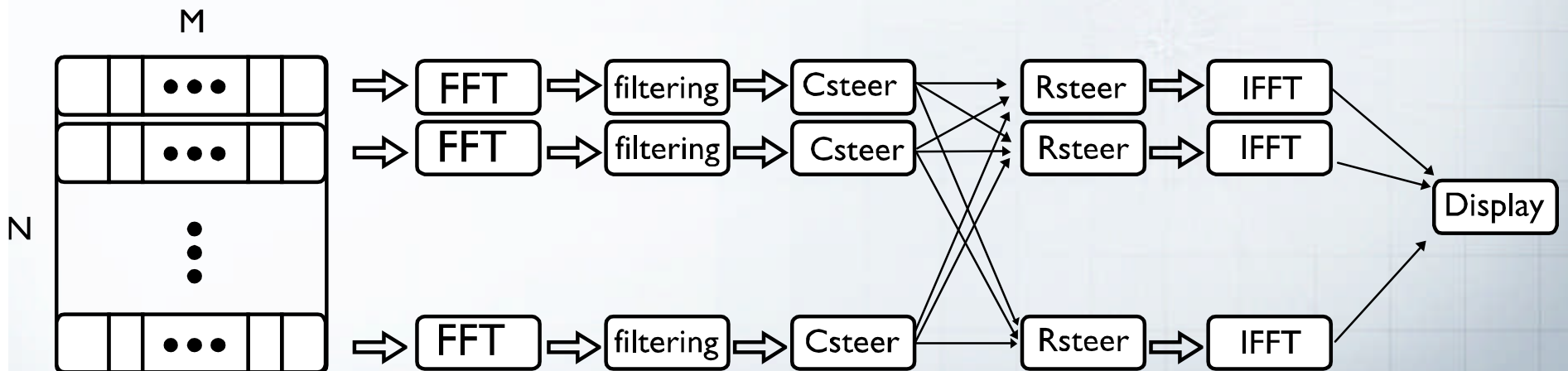

Schematic description of required processing for the 3D Conventional and Adaptive Beamformers

Key Concept – Parallel Data Processing with FPGA

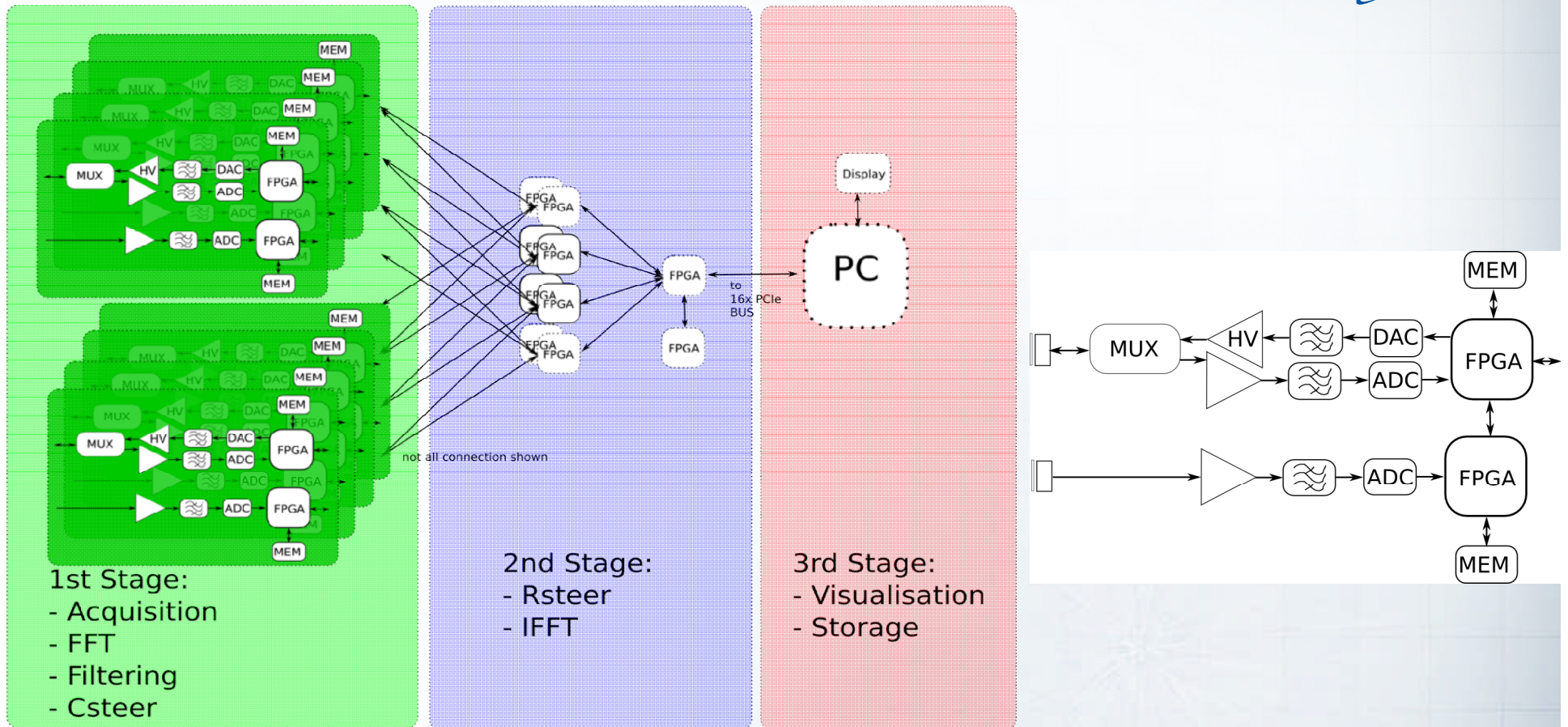

Data rate: $1024 \text{ channels} \times 4096 \text{ samples/channel} \times 14 \text{ bits/sample} \times 16 \text{ sectors/frame} \times 21 \text{ frames/sec} = 18.4 \text{ Gb/s}$

Result – Development Prototype

A quarter of the full system

256 channels for signal acquisition

Multiple parallel processing lines for beamforming

System clock @ 200 MHz

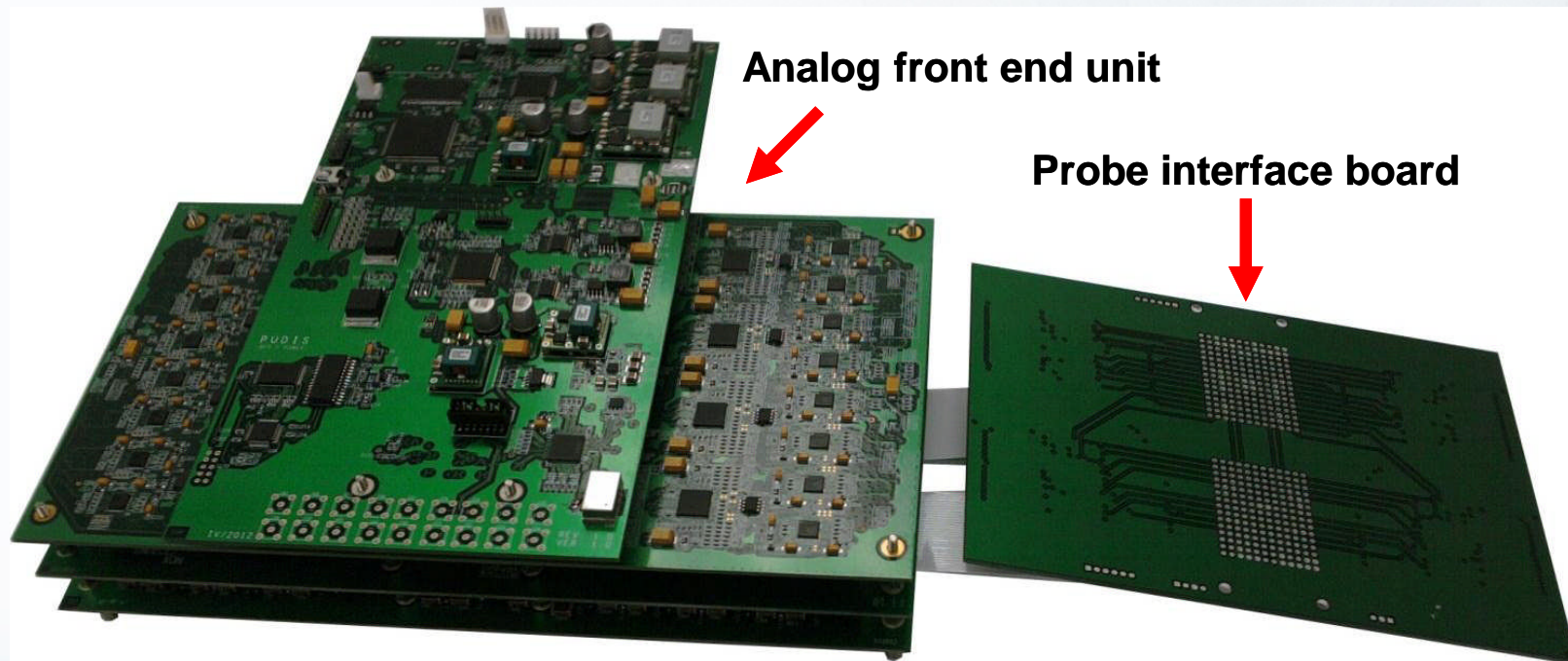

Previous Efforts: Scalable Multi-node PC Cluster

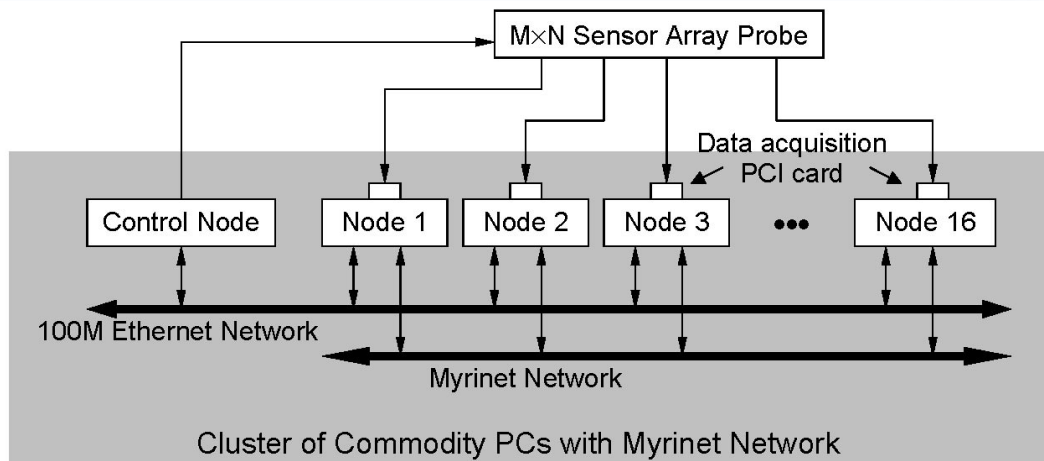

- 16x16 Transducer shown.
- 36 (6x6) channels excited by D/A to produce transmit pattern
- RF Data delivered directly to PC cluster

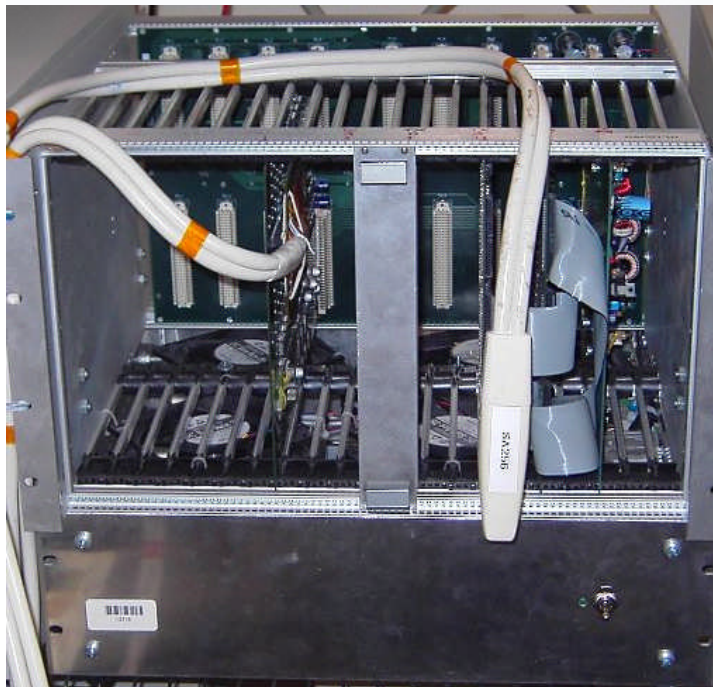

Cluster of Commodity PC's with high speed Myrinet network

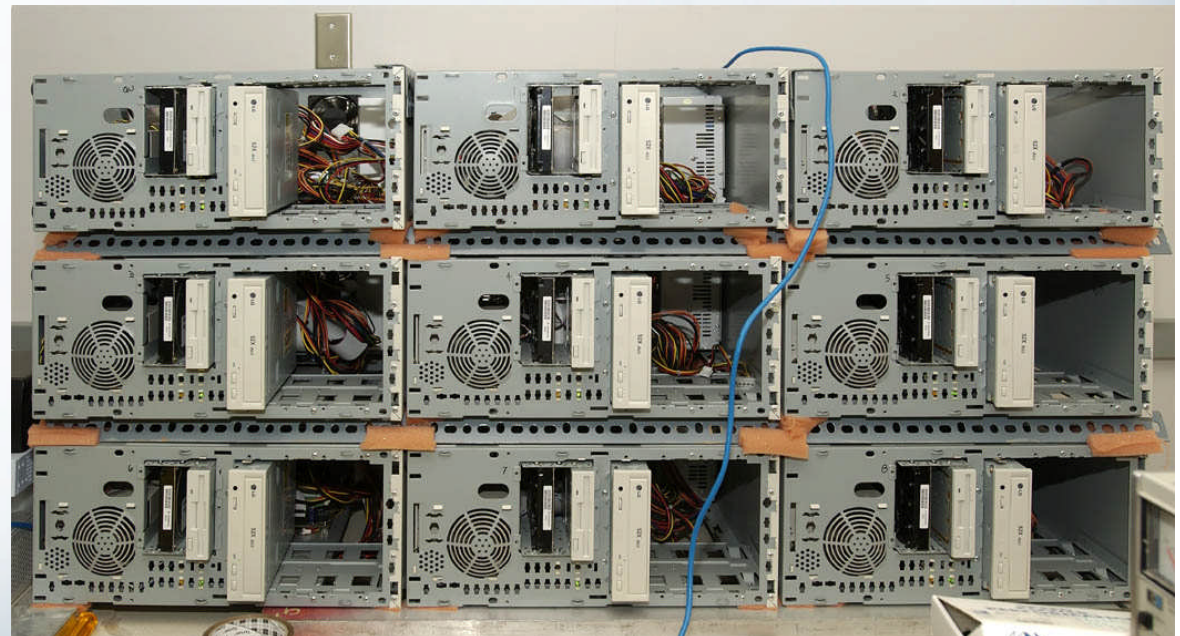

3D Volumetric Image Reconstruction using experimental 16x16 planar array

Conventional Beamforming

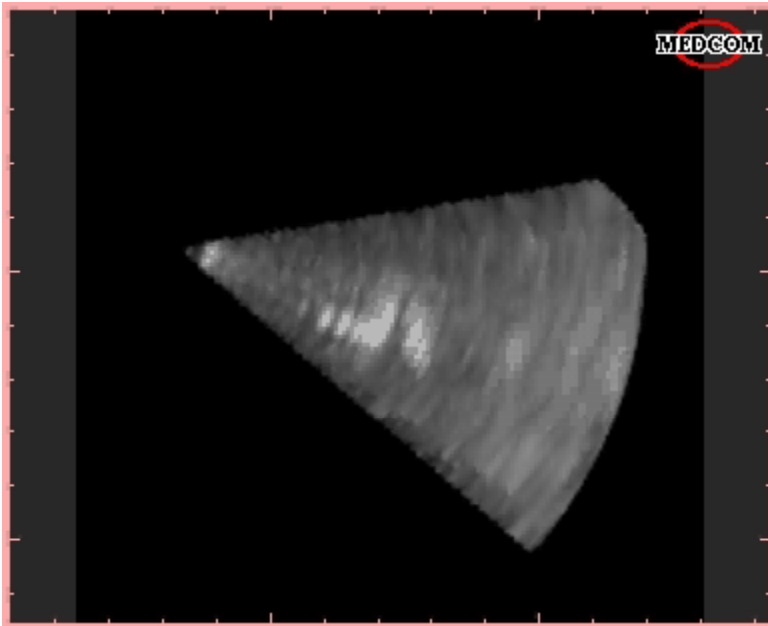

DRDC's Adaptive Beamforming

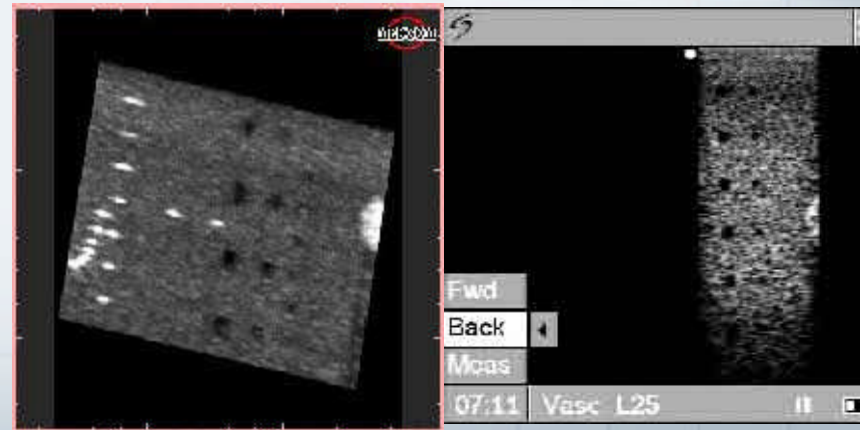
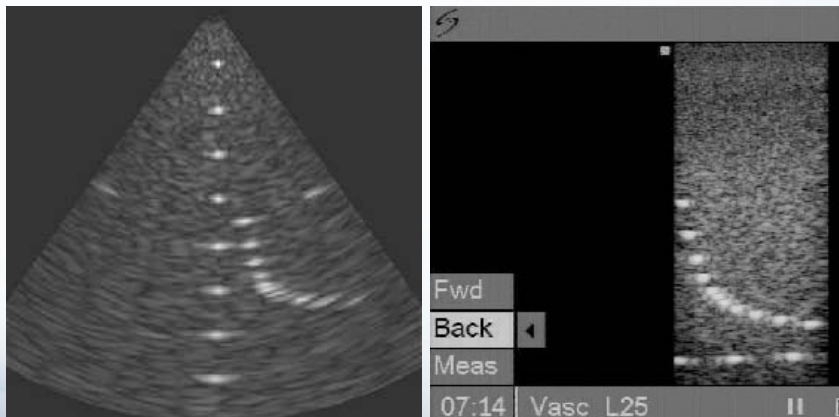
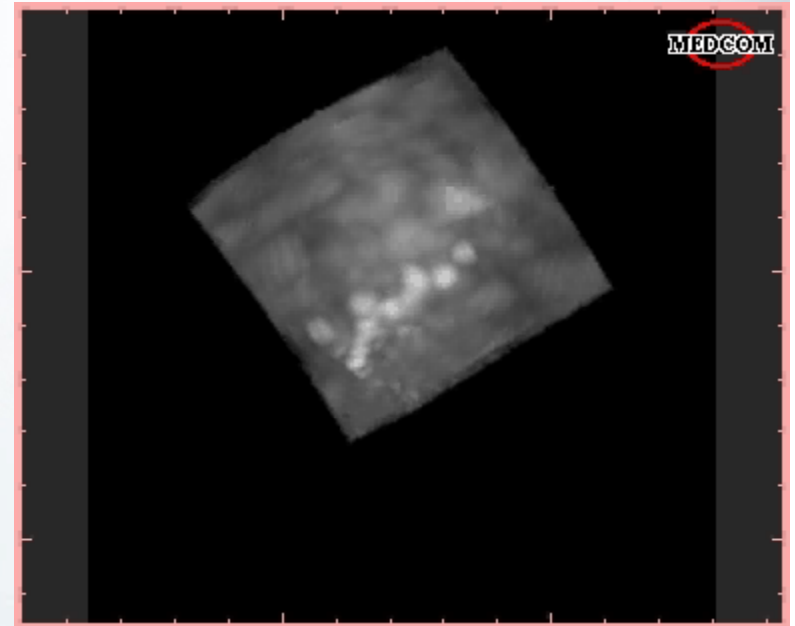

Key Concept of DRDC Ultrasound Technology

Phase Planar Array Illumination

3D Adaptive Beamforming

- Provides improved array gain performance for a 32x32 array by a factor of 4, which is equivalent in image resolution as that of a 64x64 array.

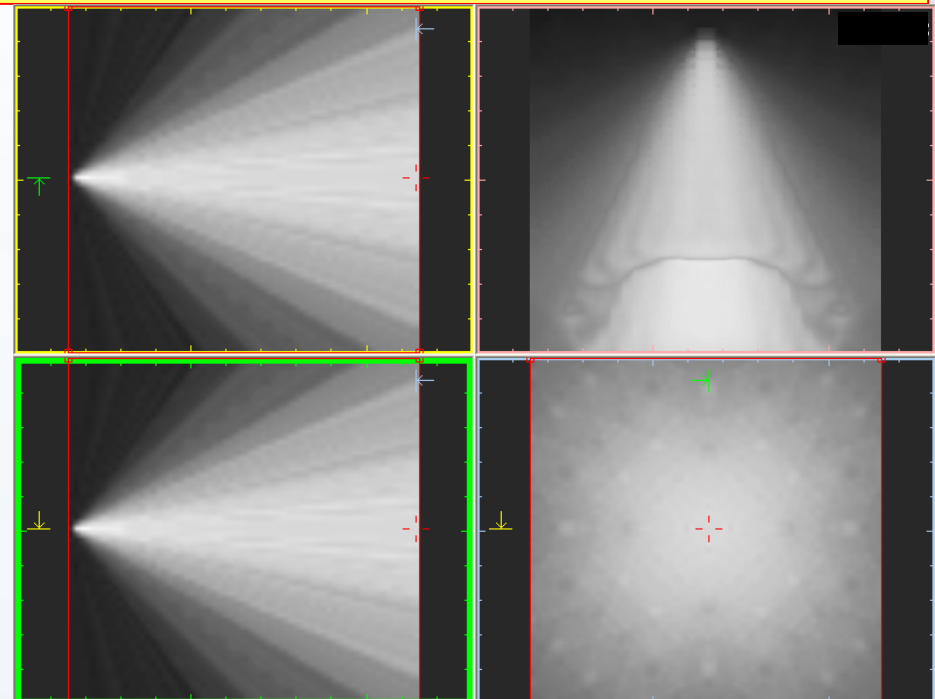

DRDC 3D Ultrasound System

- Using a planar array of 32x32 Sensors, *single illumination patterns* and 3D Beamformers to obtain complete data acquisition for 3D Image reconstruction

Result – System Performance

Processing time to acquire pulse echo signals and reconstruct 20-volumes of 3D volumetric images (12 cm depth, 80 degrees conical angle) is approximately 700ms.

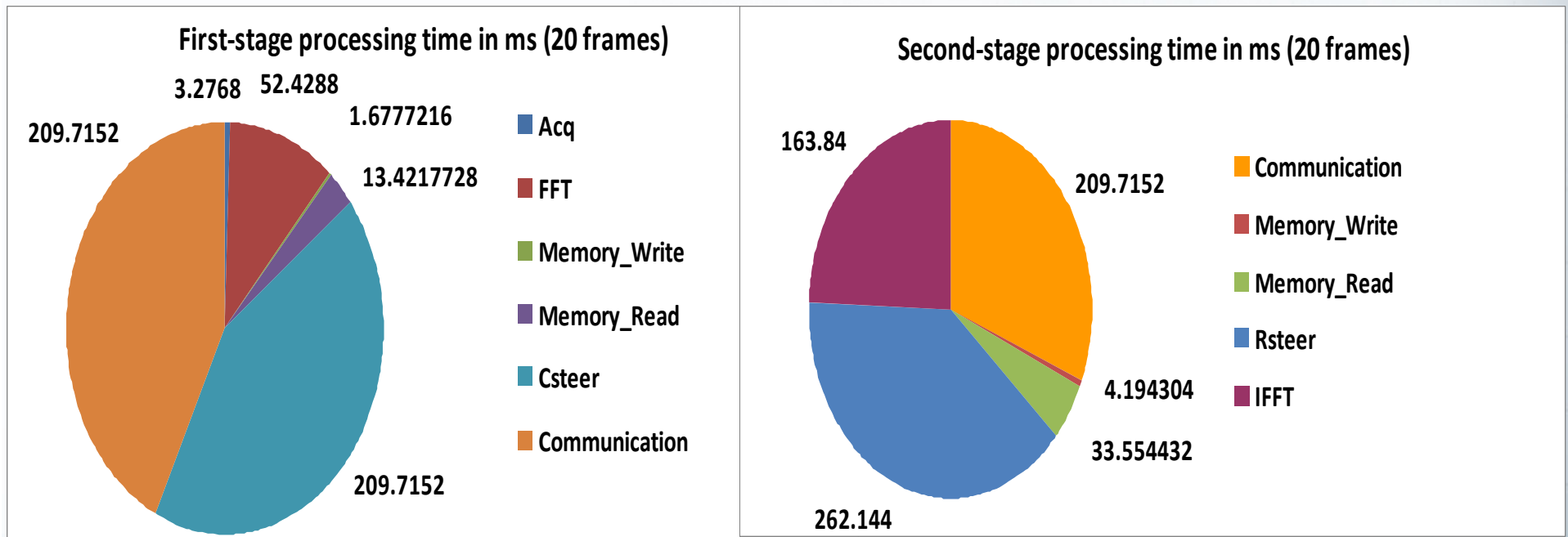

Exploitable Results (2)

3D/4D Portable Ultrasound Imaging System for Demonstration

3D Visualization & Telemedicine

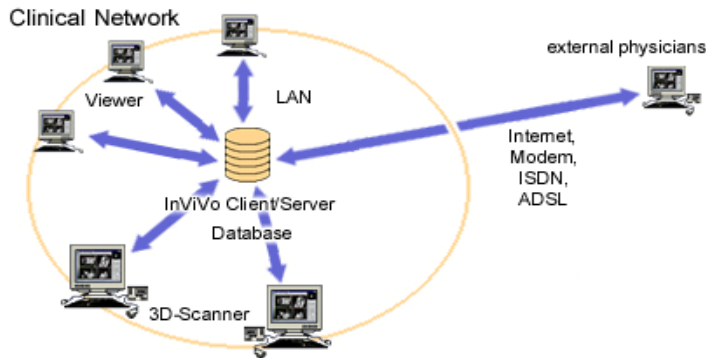

The telemedicine functionalities have already been demonstrated during April 2010 between DRDC Toronto, Fraunhofer (Germany) and the US Army labs, TATRC, Walter Reed and NIH. Col Hack, Director of the US Army MRMC on Combat Casualty Care has requested that the same demonstration should be carried at the ATACCC Conference, during August 2010.

CF H Svcs Exploitation Objectives

Continuous En Route Care

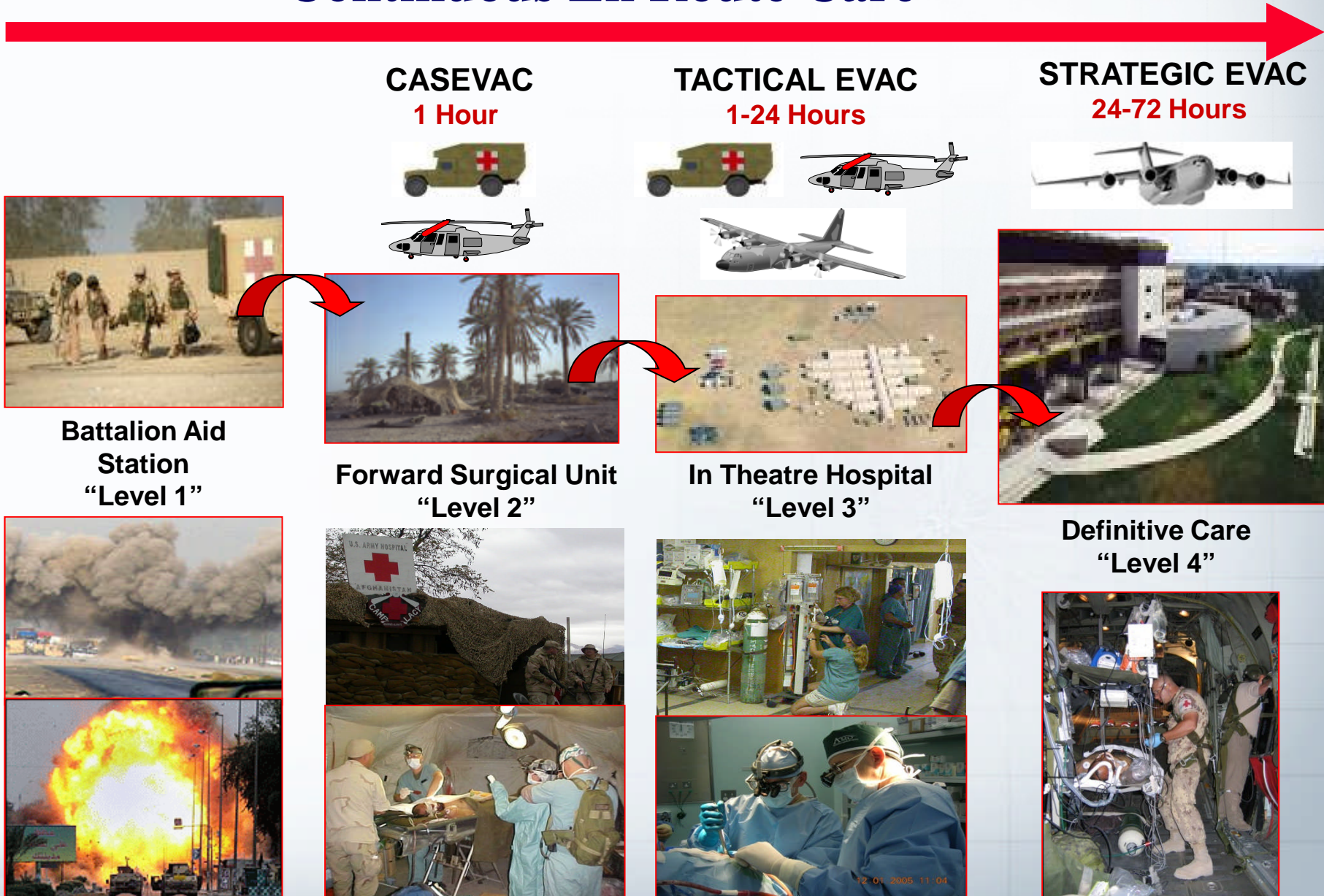

Automated Computer Aided Diagnosis for Real-time 3D Ultrasound Imaging Systems

The objective of this project is to:

Develop and clinically validate a computer aided diagnostic procedures for 3-D Ultrasound Imaging Systems that will facilitate image guided operations

FAST Procedure

- The **F**ocused **A**ssessment with **S**onography in **T**rauma (FAST) is an important ultrasound examination used to identify free intraperitoneal, intrathoracic, or pericardial fluid.
- Primarily used at patient's bedside by emergency physicians and trauma surgeons, the development of hand-held ultrasound devices facilitated the introduction of FAST into prehospital trauma management (p-FAST).
- It consists of multiple, focused, 2D ultrasonographic views of the abdomen and the pericardium and it is a process requiring intensive training.

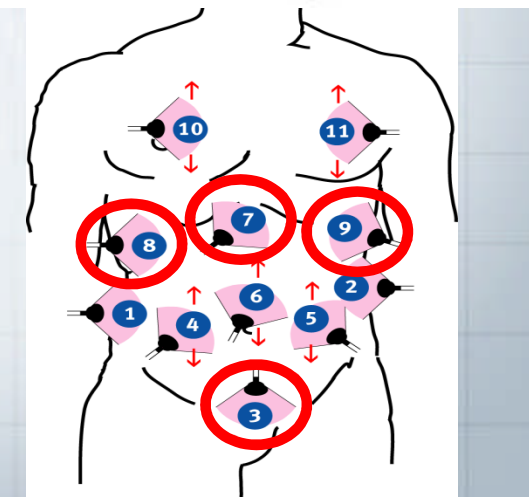
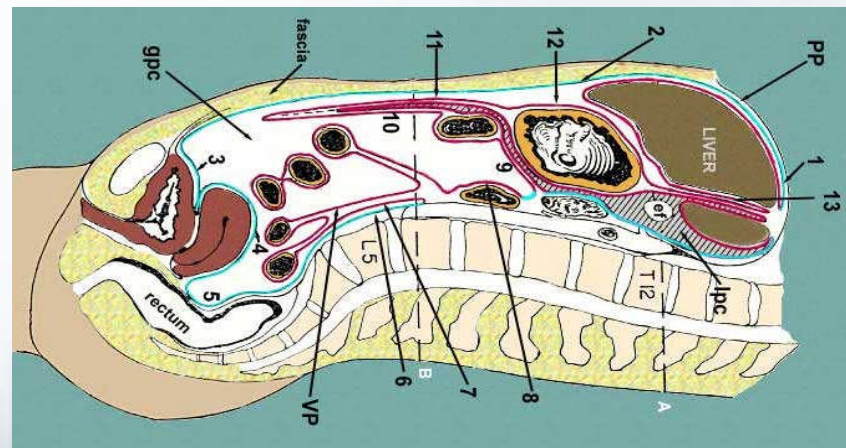
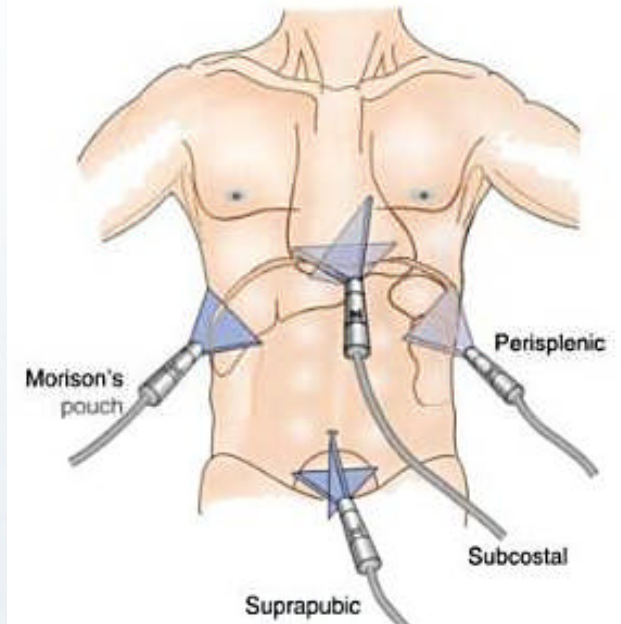

Automated Computer Aided Diagnosis for Real-time 3D Ultrasound Imaging Systems

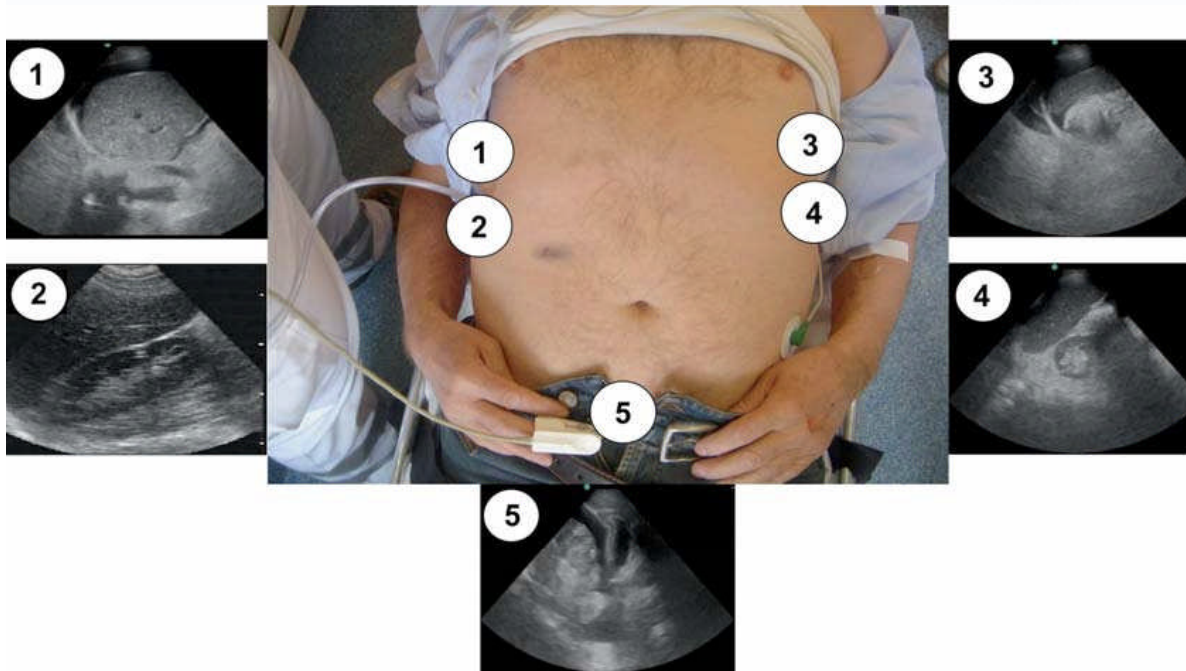

The views that comprise the FAST exam. The use of multiple views increases the sensitivity of the FAST examination in the detection of hemoperitoneum

Database collection

First, a database of 3D U/S volumetric images from 100 different subjects is established from images that are collected using 3D U/S system under FAST guideline with fluid amount ranging from minor (<100ml), significant (700~1000ml), and massive (>1500ml) from patients with ascites.

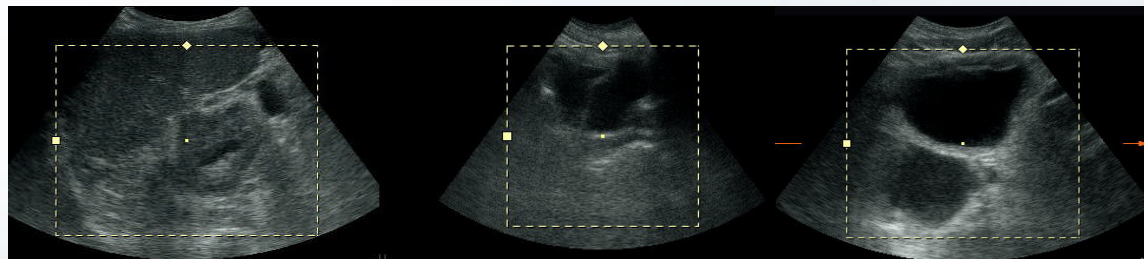

Automated Computer Aided Diagnosis for Real-time 3D Ultrasound Imaging Systems

Volume segmentation

The second part is to develop an automatic segmentation algorithm for ultrasound images that consists of image filtering, statistical analysis on speckle pattern, and contour deformation.

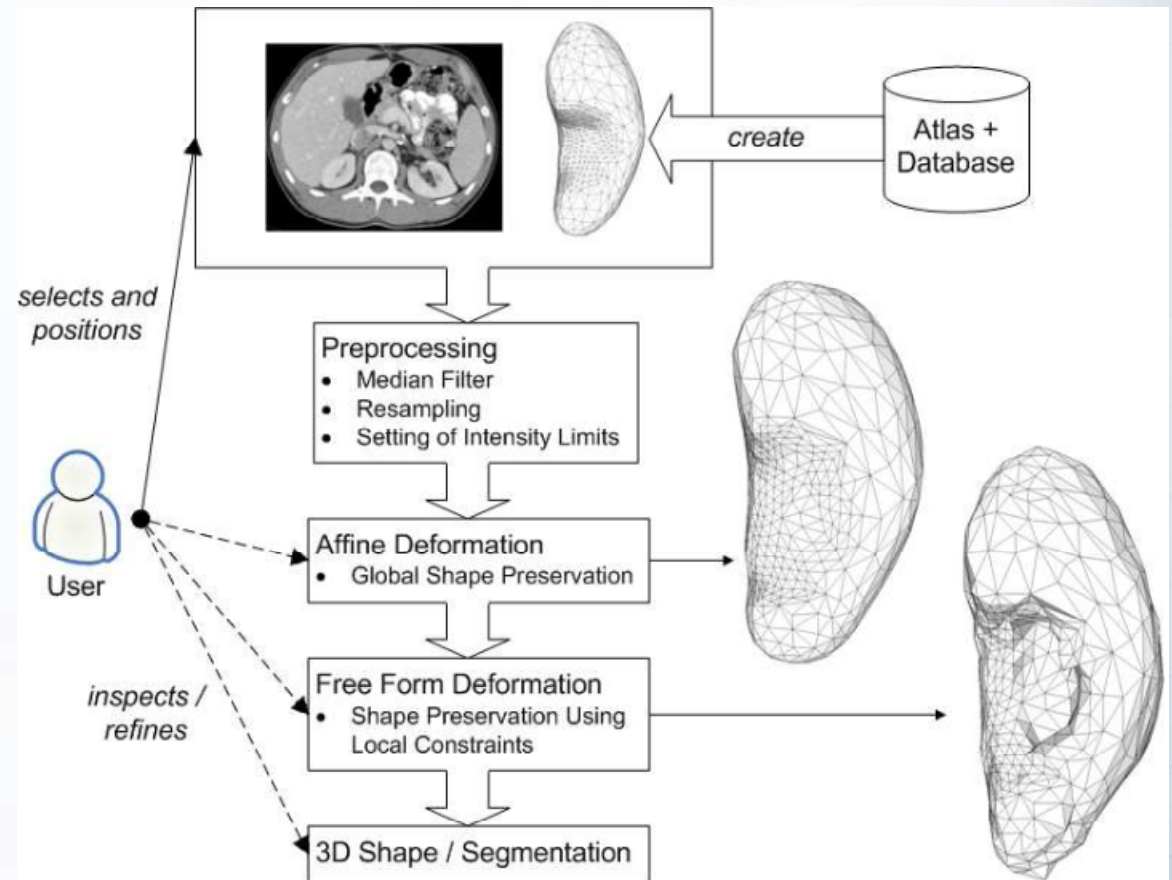

Overall Framework of 3D ultrasound CAD (computer aided diagnosis)

Step 1
Development of preprocessing and fluid segmentation

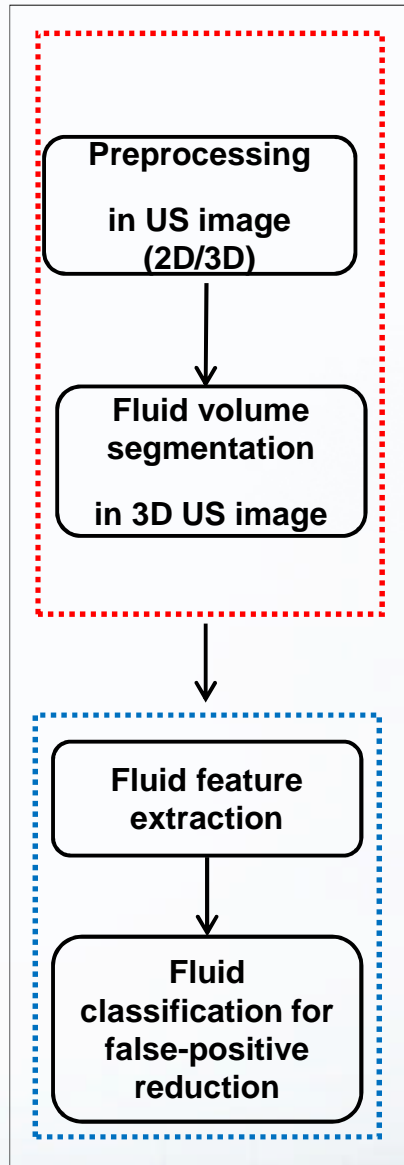

Step 2
Development of fluid classification

3D US CAD system

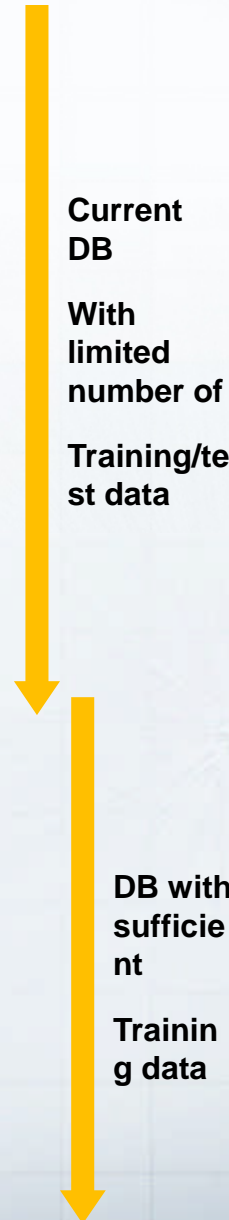
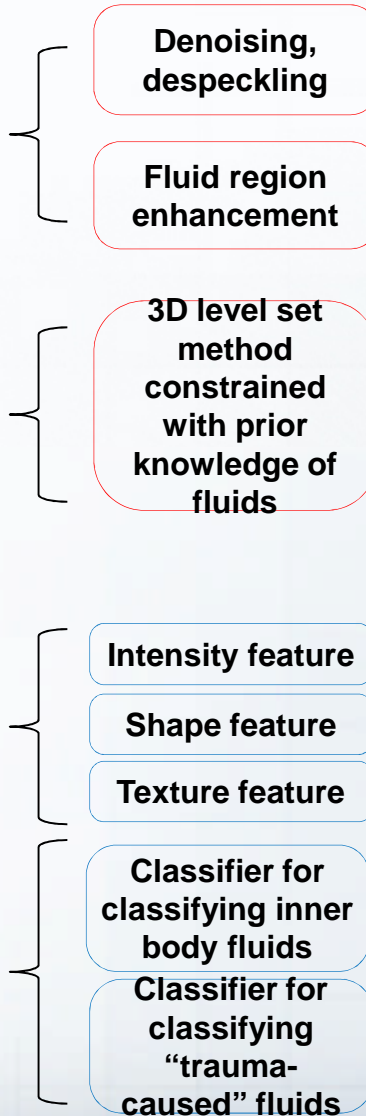

Decision support system

For each specific organ of interest, a statistical shape model will be established from hundreds of organ shapes from real patients.

The proposed decision support system includes:

- 1) pre-processing and feature extraction,
- 2) feature selection, and
- 3) classification.

This system serves as a discriminative machine learning approach that will focus on the detection of abnormalities based on the differentiation between a healthy and an injured organ

DEVELOPMENT of AUTOMATED DIAGNOSTIC CAPABILITY

Tools on Segmentation, Image Fusion to Facilitate Image Guided Automated Diagnostic Applications

Contour deformation: Affine Transformations



DEVELOPMENT of AUTOMATED DIAGNOSTIC CAPABILITY

Detection of Abdominal Bleeding

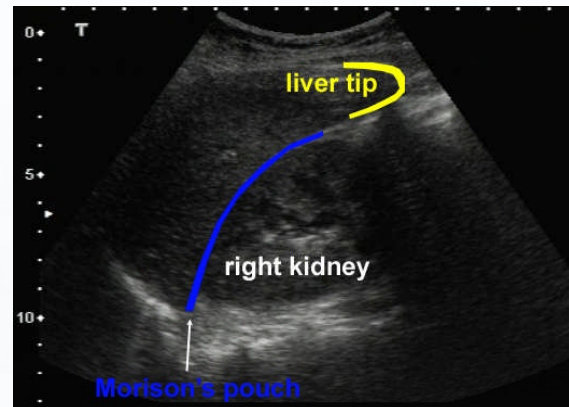
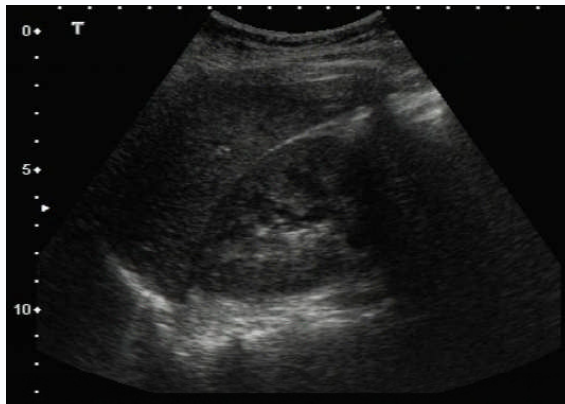

DEVELOPMENT of AUTOMATED DIAGNOSTIC CAPABILITY



Ultrasound Imaging Data Collection and Applications by using “Focus Assessment with Sonography in Trauma” (FAST) method

Expand Applications to Include:

Pneumothorax

Hemothorax

Effusion detection: accumulation of fluid between pericardium and thorax

DELIVERABLES:

Development of computer aided segmentation solutions for deformed organs

Integration of decision support systems to serve as discriminative machine learning approach for automated diagnosis

Development of image guided process of placing ultrasound probes correctly to account for anatomical variations between patients

Dispersive Ultrasound: Intracranial Injury

Closed-head traumatic brain injuries can result in damage to the brain and intracranial tissues, even when no injury is obvious on external examination

Diagnosis of such injuries is not straightforward; presently based on clinical criteria; no objective diagnostic test

Dispersive ultrasound probes the state of brain and intracranial tissues, and may have diagnostic potential



Dispersive Ultrasound: Introduction

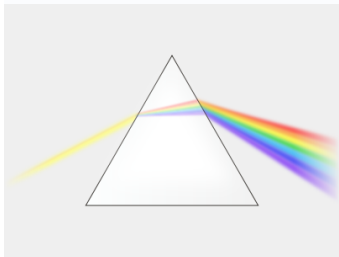

- Dispersion: waves of different frequencies travel through a medium at different speeds.
- As the ultrasound passes through biological tissues, the tissues act like a prism: the different ultrasound frequencies separate.
- The resulting frequency spectrum, or *dispersion pattern*, provides information about the tissues, and acts as a 'signature'.
- Dispersion spectra for brain and intracranial tissues have diagnostic potential.

$$c(f) = \sqrt{\frac{K(f)}{\rho_0}}$$

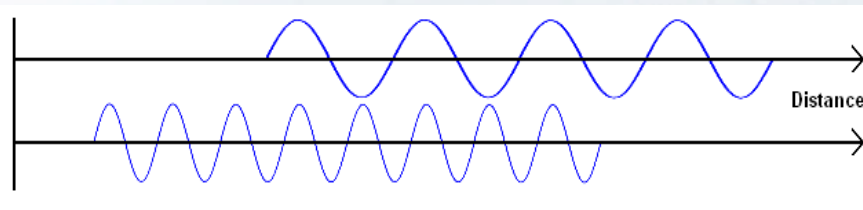

Dispersive Ultrasound: Methods

- Ultrasound probes placed on either side of head, on temporal bone; signal transmitted from one side to the other
- System transmits and receives ultrasound pulses through medium at **multiple frequencies**
- Propagation time for each frequency calculated: **dispersion spectrum.**
- Support Vector Machine (SVM) is used to identify the medium on the basis of the dispersion pattern

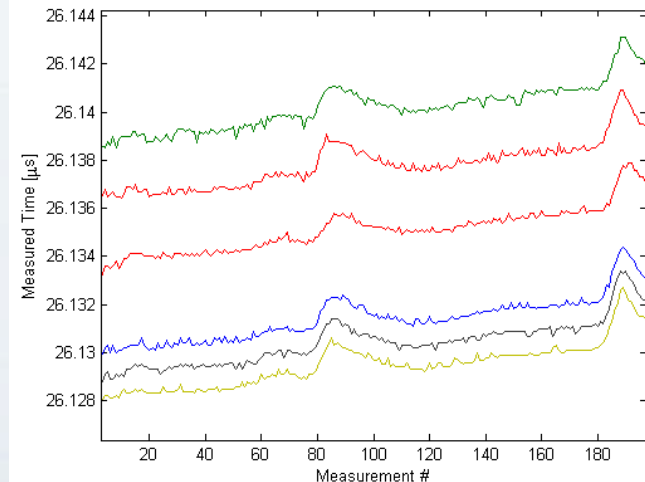
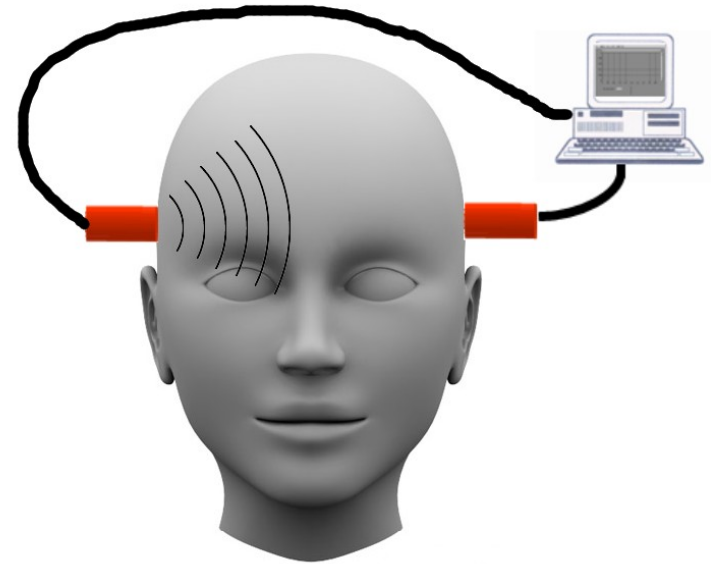

Dispersive Ultrasound: Decision Support

- Support Vector Machines (SVM) are a type of learning machine useful for classification tasks.
- SVMs sort data into pre-defined classes.
- The classes are defined during pre-processing, by ‘training’ the SVM on numerous examples.

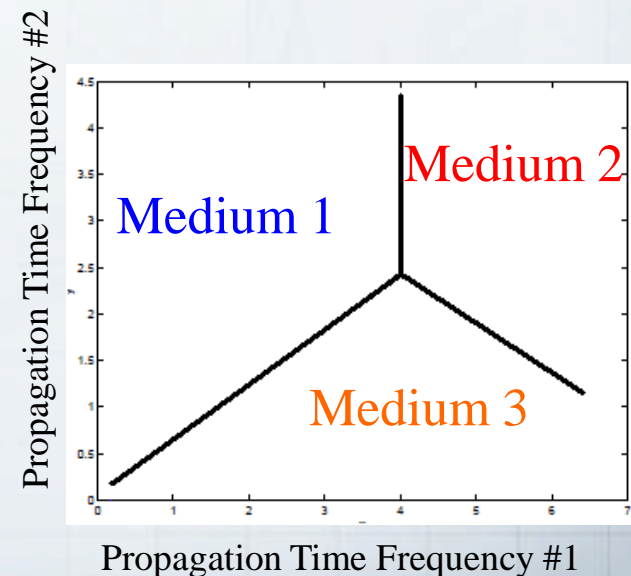
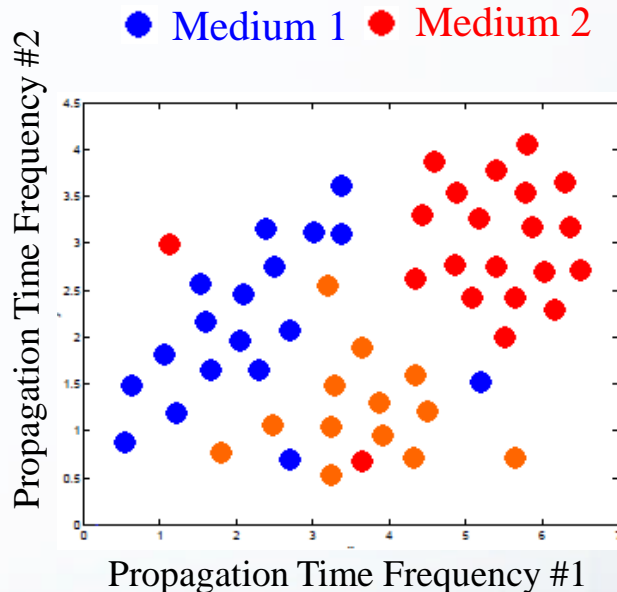

Dispersive Ultrasound System (DUS): Brief Development History

- First prototype developed in 2001. (Stergiopoulos and Wrobel; Patent 7854701; 2004)
- Second prototype, with more robust construction, developed in 2008.
- Current system, meeting federal standards for use as a medical device, developed in 2011.

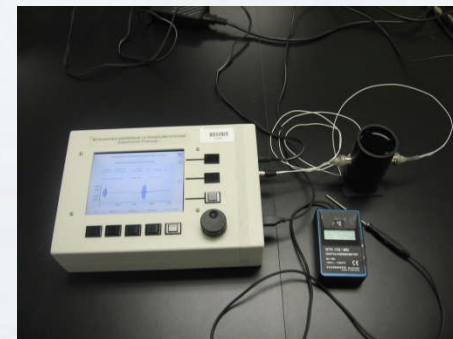
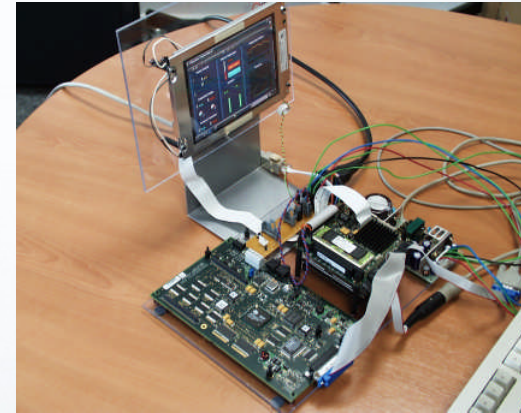

Dispersive Ultrasound System (DUS): Brief Development History

- Initial applications: homogeneous media
 - Fluid classification
 - High success rate (~90%)
- Sensitivity tests in biological applications
 - Pain response in rats
 - Established correlation between neural pulses and dispersive ultrasound signal
- Preliminary blast injury study
 - 4 rats; data collected prior to blast exposure, and at 0h, 24h, 48h post-exposure
 - DUS able to distinguish pre-exposure and 24h post-exposure rats with >80% confidence

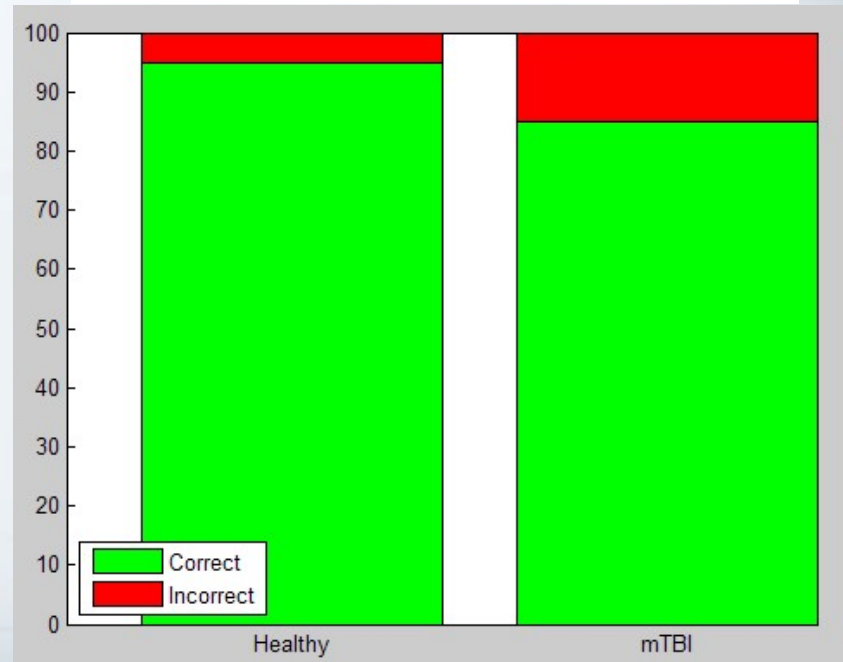
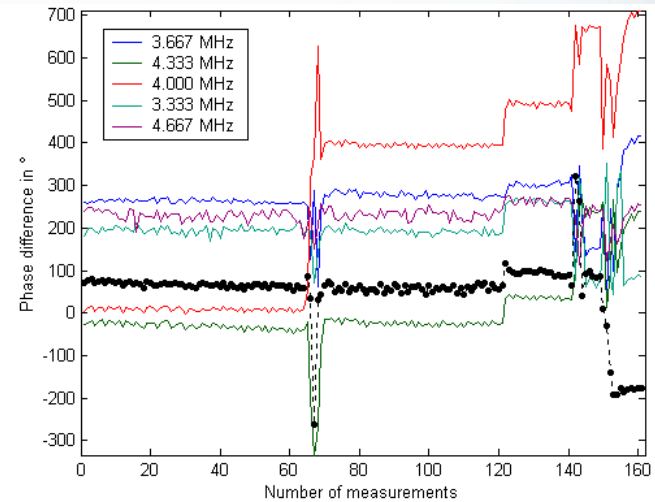

DEFENCE



DÉFENSE