

The Tenth International Conf. on Networks (ICN 2011)

January 23-28, 2011 - St. Maarten, The Netherlands Antilles

A Tutorial on:

“Lifecycle Management for Telecommunication Networks”

Professor Andy Snow, PhD

School of Information & Telecommunication Systems

Ohio University

asnow@ohio.edu

Tutorial Based on Book

- Lifecycle Management for Telecommunication Networks
- Two intended audiences
 - Professional Handbook
 - Individuals, corporations
 - Training seminars/courses
 - University Textbook
 - Capstone course in undergraduate telecom programs
 - Graduate course in telecom programs
- Status
 - Draft book complete
 - In process of selecting publisher; target publication by Fall 2010
 - Looking for feedback on content
- If interested in book, please contact author at asnow@ohio.edu

Typical Telecommunications Network Environment

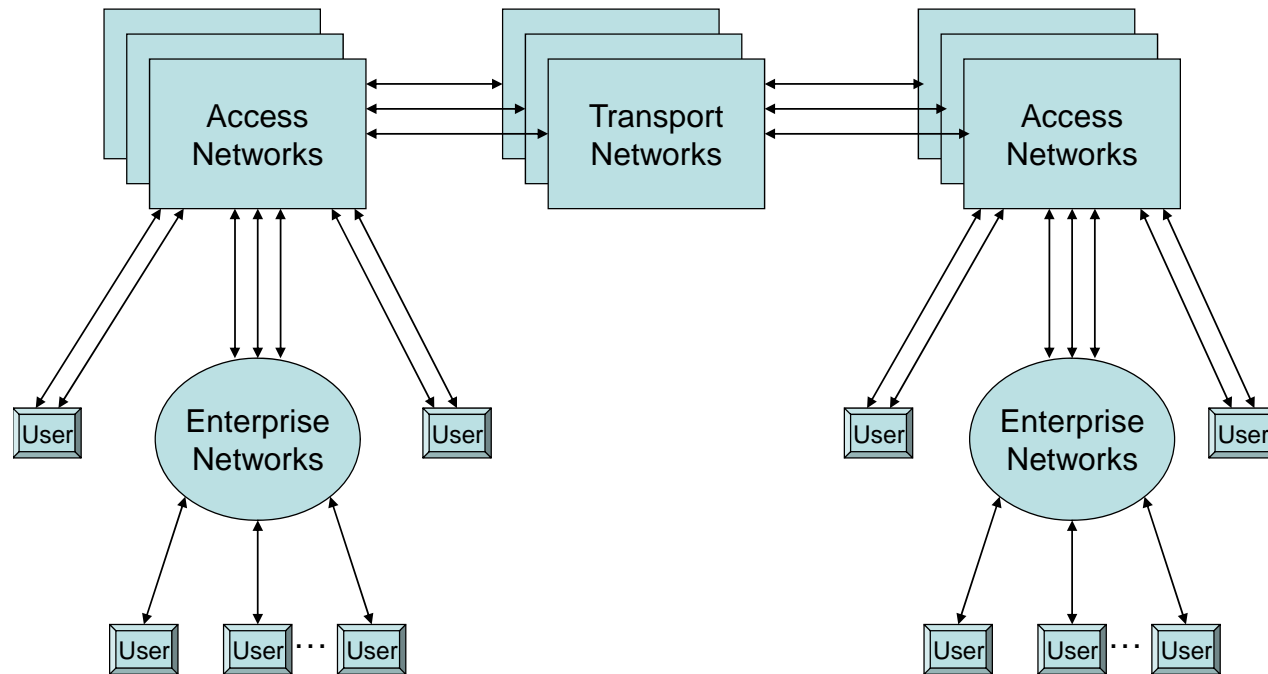

Network Infrastructure and Application Convergence

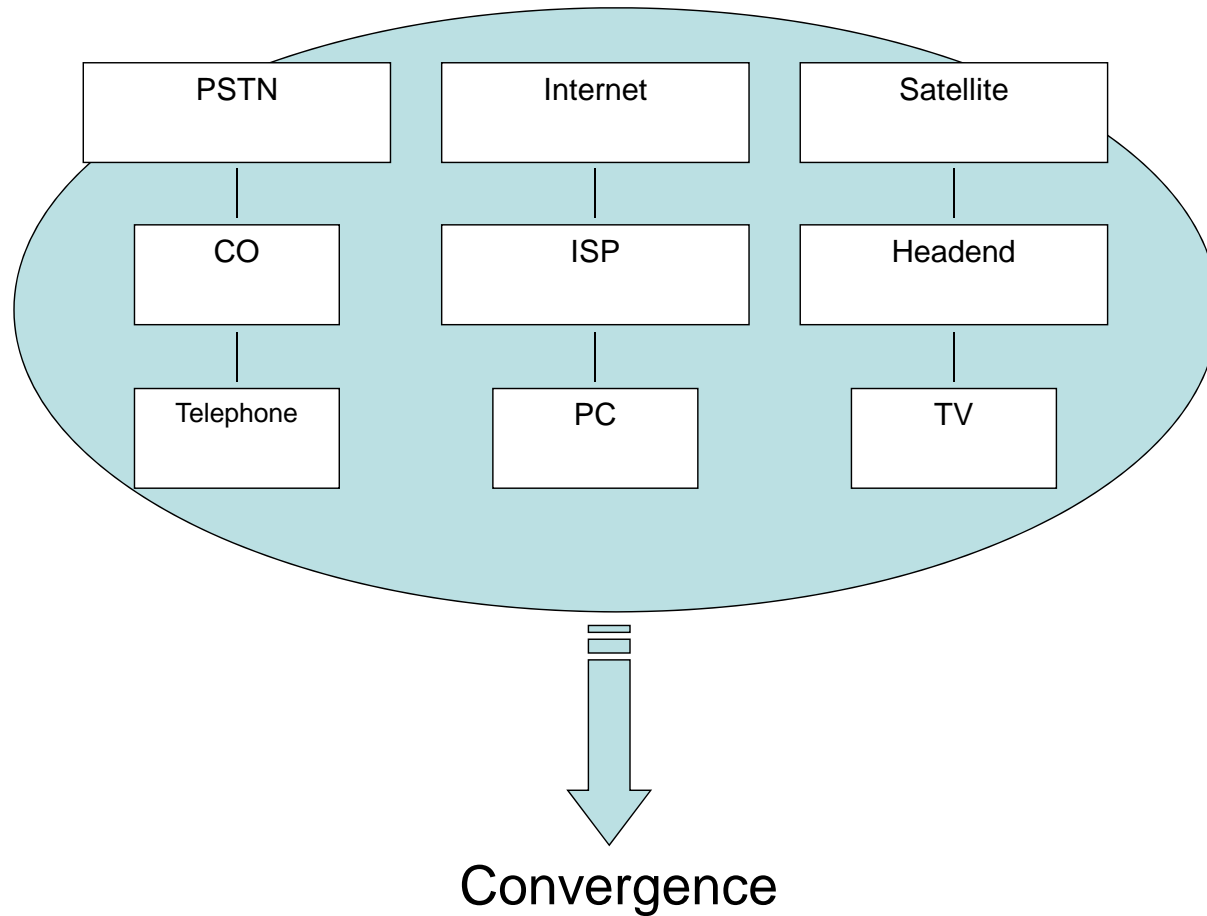

There are Many Stakeholders in the Telecommunication Network Domain

- Consumers
- Corporate/Nonprofit/Government Organizations
 - Users
 - Network and System Administrators
 - Executives
- Service Providers
 - Traditional Carriers
 - Internet Service Providers
 - Cable
- Policymakers
 - Regulators
 - Legislators
 - Consumer Advocates
- Equipment and System Vendors

Why is this Challenging?

- Each network is unique - Spatially, in usage, and in offered services
- Projects are often migration or upgrades rather than fresh starts
- The network is often part of a larger project or system, such as an IT project
- It is difficult to separate performance requirements from end user applications
- Everyone is an expert -- users mistake vendor solutions for requirements
- Project management visibility is difficult because of geographic dispersion
- It is easy to underestimate the largest cost component – operations & maintenance
- Rapid technological evolution makes network deployments ripe for obsolescence and unsuccessful emerging standards
- A myriad of service providers and product vendors results in complex decisions and tradeoffs
- Convergence complicates the ability to offer consistent quality of service to all traffic types and applications
- Projects are not properly separated from day-to-day network operations for in-place networks
- No extant PM methodology is dedicated to network integration

Overview of Lifecycle Management

- A combination of
 - Lifecycle management
 - Project management
 - Systems engineering

Roles in a Project

- **The Project Manager:** *The one person responsible for achieving project objectives and satisfying the customer.*
- **The Customer:** *The customer is the individual or organization who pays for the project.*
- **User:** *Users are the individuals or organization receiving beneficial use of the delivered product or service. In some projects, the customer and user are the same entity while on others they are two different entities.*
- **Executive Management:** *The manager responsible for seeing that the organization using the product or service is successful. The project manager may or may not report to the executive manager – often these two individuals are in different companies.*
- **Experts:** *The individuals who provide expertise in order to perform project task activities.*

Project Management

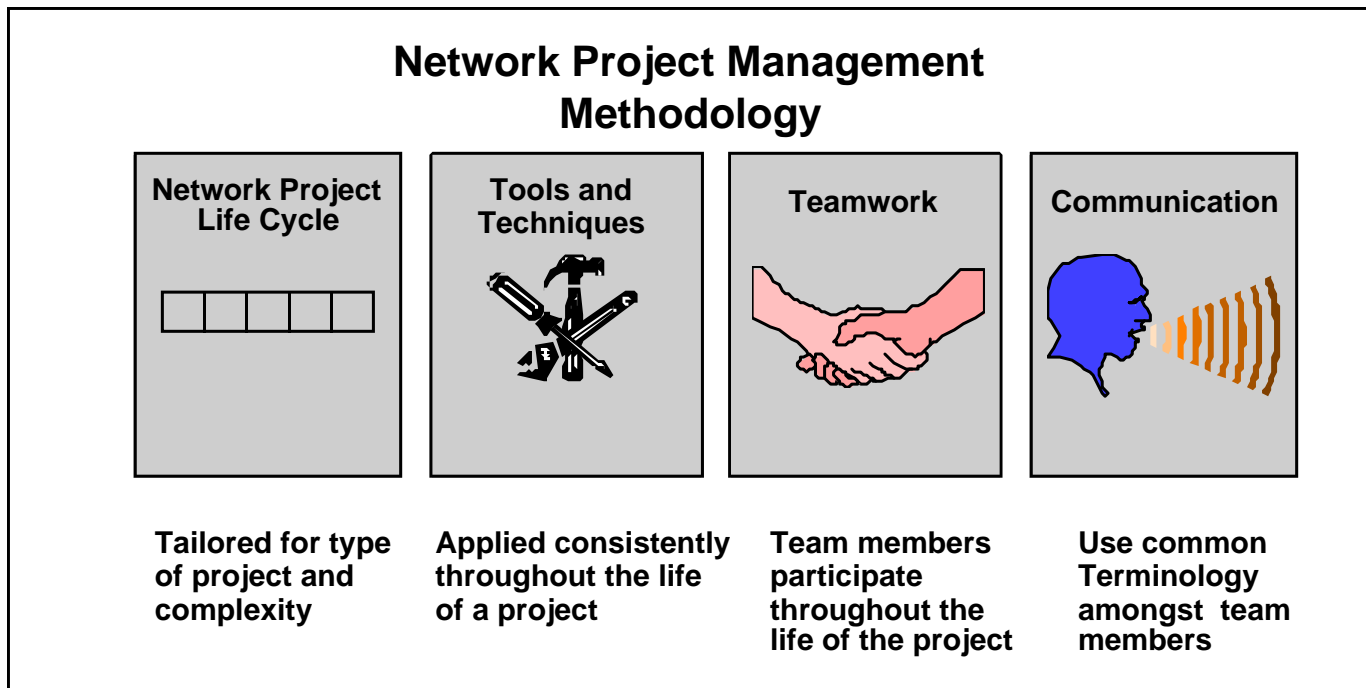

Network Lifecycle Stages

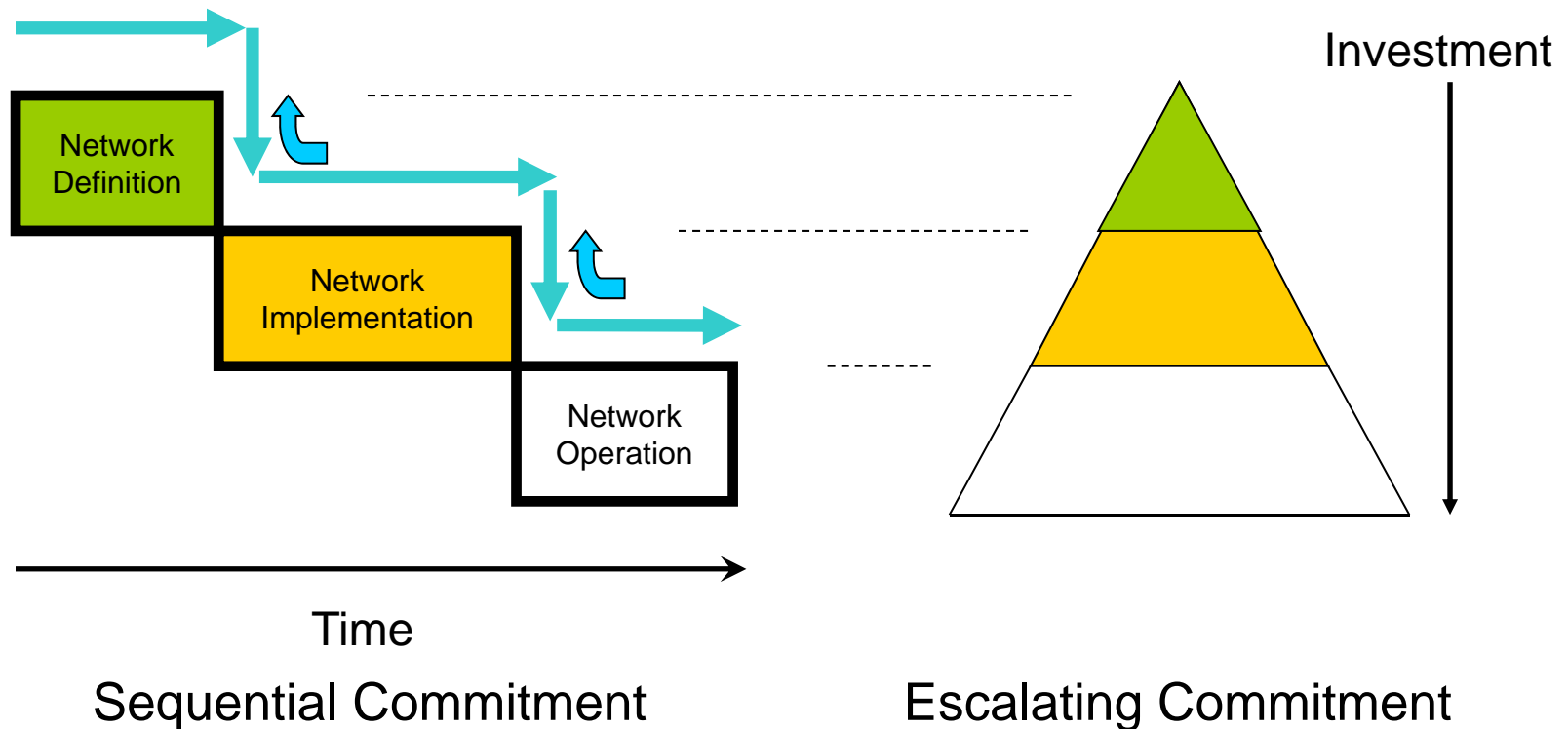

A "Waterfall" Lifecycle Approach

Network Lifecycle Stages and Phases

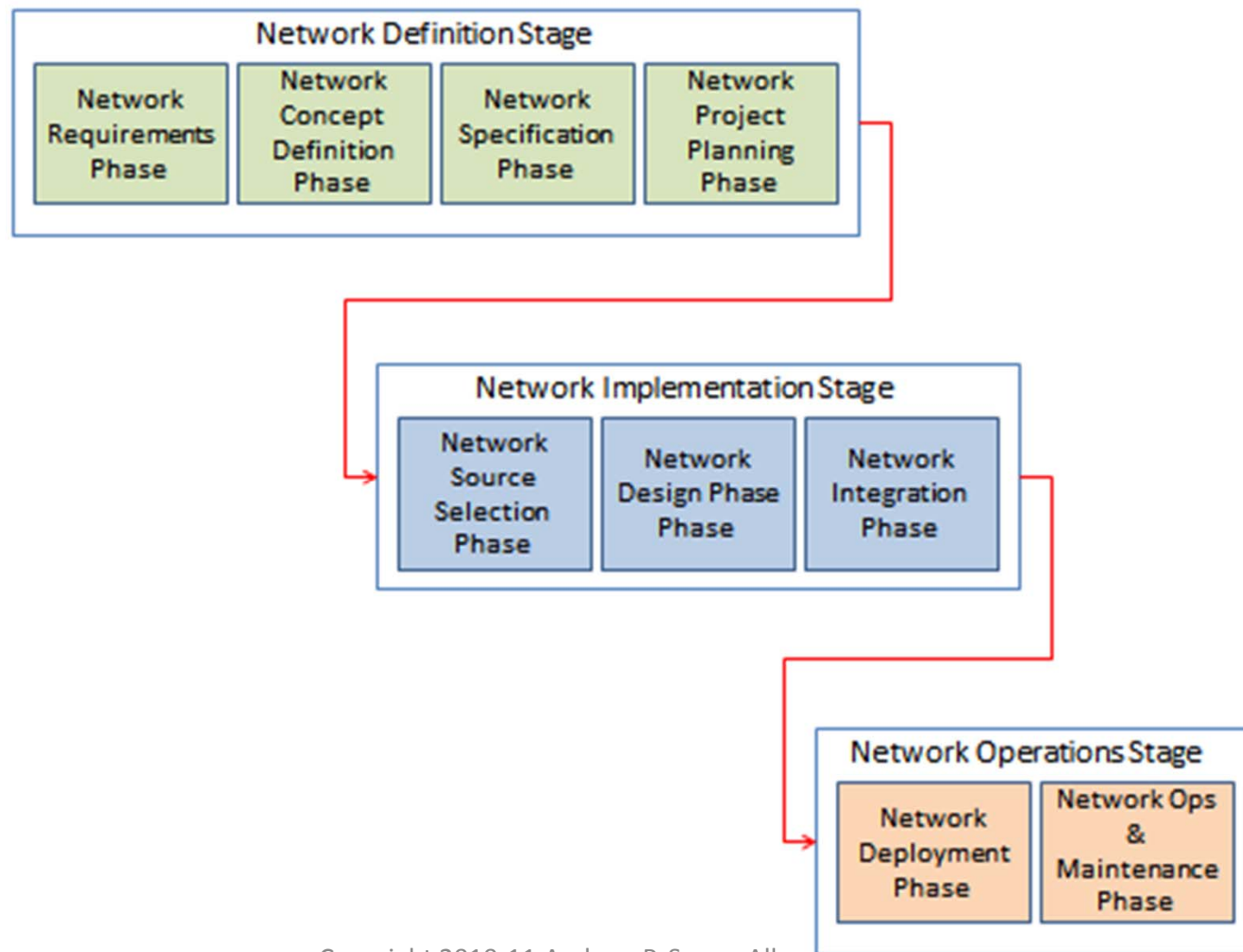

Control Gates

- **Control gate:** A lifecycle phase go/no-go decision point, usually accompanied with a review of phase objectives and documentation.
- Should include appropriate project stakeholders
- Can be a formal presentation
- Outcomes:
 - Green Light: proceed to next project phase
 - Yellow Light: must address minor deficiencies before proceeding
 - Red Light: (1) redo phase, or (2) terminate project

Outline

PART ONE INTRODUCTION

- Chapter 1 Network Lifecycle and Project Management Methodology
- Chapter 2 Network Project Archetypes

PART TWO NETWORK PROJECT DEFINITION

- Chapter 3 Network User Requirements
- Chapter 4 Network System Requirements
- Chapter 5 Network Concept Definition
- Chapter 6 Network Specification
- Chapter 7 Network Project Planning

PART THREE NETWORK PROJECT IMPLEMENTATION

- Chapter 8 Network Source Selection
- Chapter 9 Network Design and Integration

PART FOUR NETWORK OPERATIONS

- Chapter 10 Network Deployment
- Chapter 11 Network Operations & Maintenance

PART FIVE PROJECT MANAGEMENT ELEMENTS

- Chapter 12 Project Configuration Management

Network Project Archetypes

- Network project “archotyping” is the process of comparing the anticipated network effort to the characteristics of a set of archetypal network projects, and placing the proposed effort into one of these known project categories

Network Project Archetypes

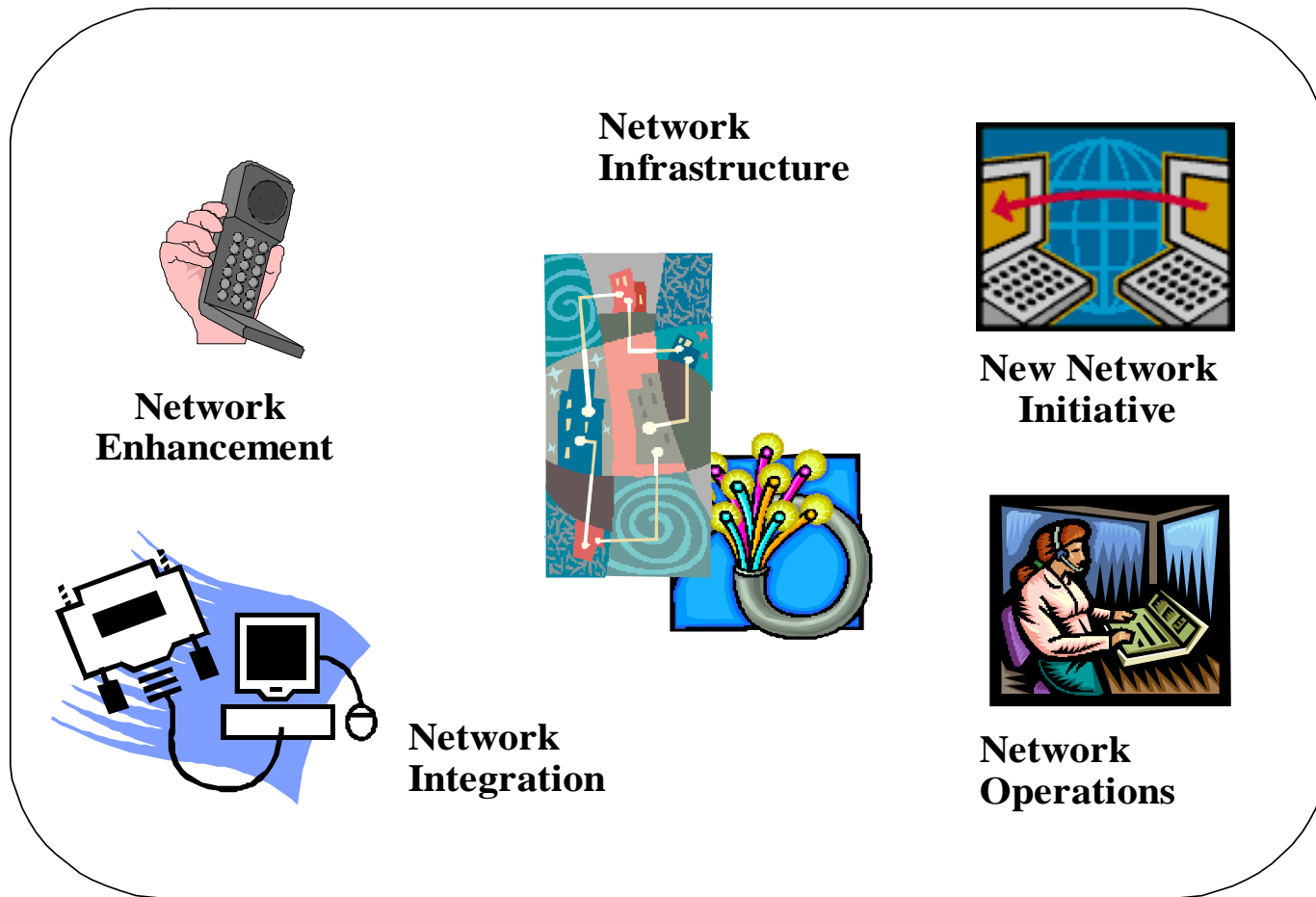

Network Project Archetypes

- New network initiative project is typically a “fresh start” in that the project creates a new network that did not exist before, rather than modifying an existing network.
- Network enhancement project is a major enhancement to an existing network.
- Network operations and maintenance project is incremental functionality/performance refinements to an existing network that has been deployed and turned over to an operational organization.
- Network integration project provides the network services required to support an Information Technology (IT) Project
- Network infrastructure project provides network/communication utilities or infrastructure within a new or existing building

Network Definition Stage

- Network Requirements: Defines what the user network needs (user requirements) and the criteria for selecting the best solution (system requirements)
- Network Concept Definition: Describes the best approach for solving the user network needs, by way of the selected network architecture
- Network Specification: States how well the network must work to satisfy user needs, by specifying the attributes of the major components in the network architecture necessary to meet system requirements
- Network Project Planning: Develops a plan for acquiring a network solution, allowing the project team to commit to a project budget and schedule.

Network Definition

STAGES & PHASES	NETWORK DEFINITION STAGE				
	Network User Reqts Phase		Network Concept Definition Phase	Specification Phase	Network Planning Phase
MAJOR ACTIVITIES	Collect Network User Reqts	Establish Project Control Board	Tradeoff Candidate Net Concepts	Allocate Sys Reqts to Major Network Components	Select Acquisition Approach
	Validate Requirements	Derive Network System Requirements	Identify Risks	Develop Verification Approach	Develop Network Project Implementation Plan
	Prepare Initial Plan	Define Concept Selection Criteria	Assess Technical Feasibility	Develop Major Component Specs	Commit Resources
			Estimate LifeCycle Costs	Trace Component Specs to Sys Reqts	
			Select Concept		
PRODUCTS	User Reqts Document	Network System Requirements Document	Trade-off Results	Net Performance Specification	Network Project Implementation Plan
	Initial Project Plan	Traceability Matrix	Network Concept of Operations	Major Component Specifications	- Tasks - Schedules - Resources - Responsibilities
		Concept Selection Criteria	Feasibility Models	Traceability Matrix	
			"Should Cost"	Network Verification Plan	Funding Document
CONTROL GATES	Network User Reqts Review (URR) ▲	Network System Reqts Review (SRR) ▲	Network Systems Concept Review (SCR) ▲	Network Spec Review (NSR) ▲	Source Selection Initiation Review (SSIR) ▲

Pay Me Now or Pay Me Later

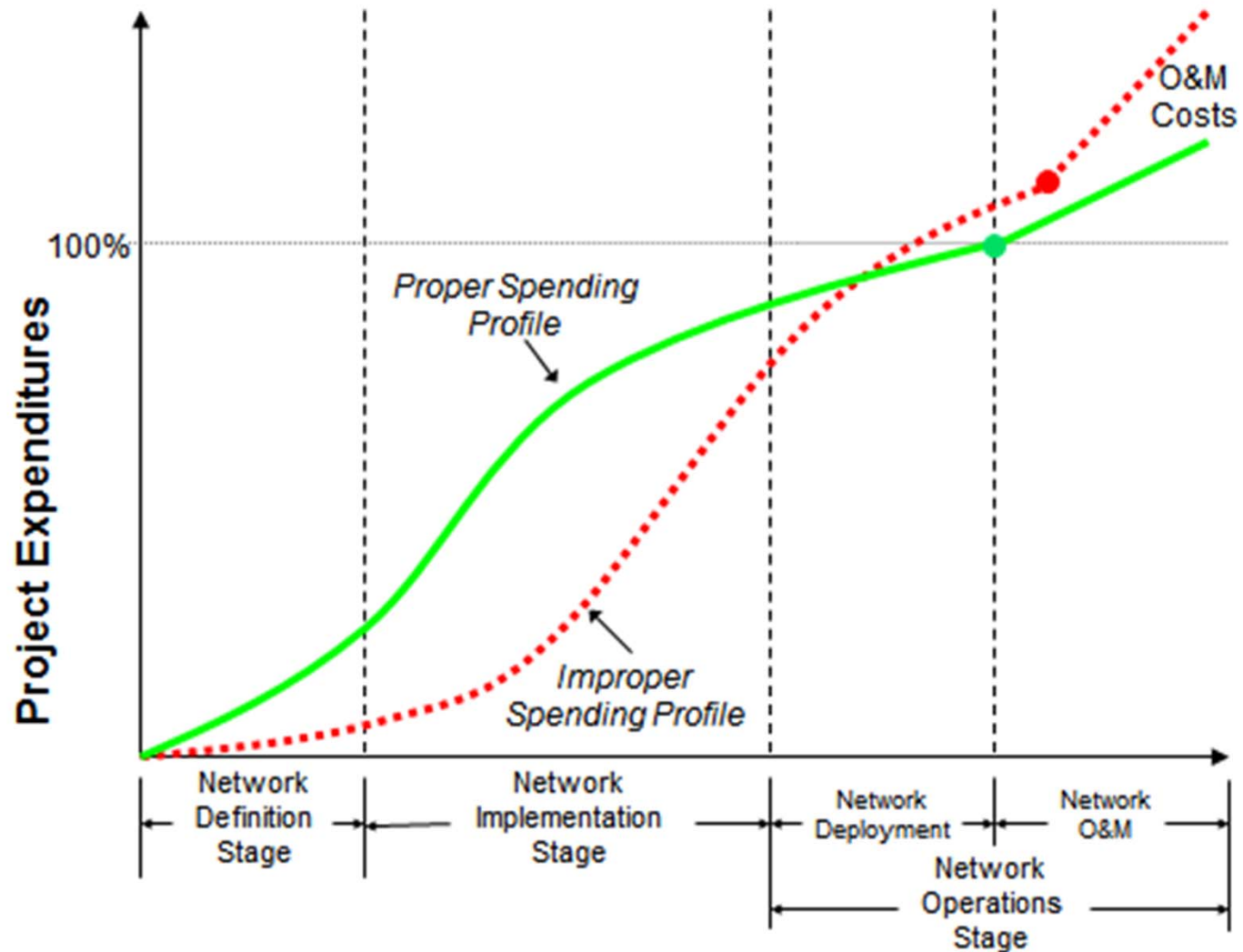

User Requirements are Solution Free

- **User Requirement:** *A capability needed by the user(s) to solve a problem or achieve an objective, or support a business process.*
 - **Operational Needs and Capabilities**
 - **Schedule Requirement for New Capabilities**
 - **Interface Requirement to Retained Systems**
- **User requirements are “solution free”**
- **Want:** A perceived need that is often a proposed solution, often costs too much, may not be deliverable on time, can be technically infeasible and/or represents high risk.
 - “I want a Mercedes.” vs. “I need transportation.”
 - “I want a cell phone” vs. “I need to call McAllen, TX four times a day”

Types of Users

- Executive management users,
- Network administrator users, and
- Network/end product users.

Example of Different User Perspectives on Same General Need

- “Without revenue I can’t make a profit. Because of the limitations of our voice and IT system, our inside salespeople are losing sales.”
- “The current call center equipment is hard to maintain and requires too many people to keep it running. In addition, I need network management capabilities well beyond what I now have.”
- “As an inside salesperson, I can tell you right now that I need to see a screen telling me how many incoming calls I have queued up. When I answer a call, I could work faster if I knew who is calling and, if the caller is an existing client, could see their account information already displayed.”

User Requirements Example: Peak Voice Traffic Between Locations

Peak Hour Call Volume

- A - Chicago Office
- B - Columbus Office
- C - McAllen Office
- D – Through PSTN

OUTGOING CALLS/HR									
LOCATION		A	A	A	B	B	B	C	D
	UNIT	HQ	FIN	SAL	PM	ENG	R&D	MAN	PSTN
A	HQ	X	X	X	10	5	5	15	20
A	FIN	X	X	X	10	10	5	20	40
A	SAL	X	X	X	30	20	10	20	50
B	PM	10	10	30	X	X	X	20	15
B	ENG	5	5	10	X	X	X	30	30
B	R&D	5	5	3	X	X	X	5	10
C	MAN	5	20	30	20	15	2	X	50

Peak Hour Call Duration

OUTGOING HR/CALL									
LOCATION		A	A	A	B	B	B	C	D
	UNIT	HQ	FIN	SAL	PM	ENG	R&D	MAN	PSTN
A	HQ	X	X	X	0.1	0.1	0.1	0.2	0.2
A	FIN	X	X	X	0.2	0.1	0.05	0.2	0.2
A	SAL	X	X	X	0.2	0.1	0.1	0.2	0.2
B	PM	0.1	0.1	0.2	X	X	X	0.2	0.1
B	ENG	0.1	0.1	0.2	X	X	X	0.2	0.15
B	R&D	0.05	0.1	0.05	X	X	X	0.05	0.2
C	MAN	0.2	0.2	0.1	0.2	0.2	0.05	X	0.2

Gathering Requirements

- Documentation review,
- Interviews,
- Surveys and
- Focus groups.

Network System Requirements

- Network system requirements are the set of attributes the network must have in order to satisfy the network user requirements.
- User requirements must be translated into system requirements -- statements that can be proven or verified.
- System requirements are also solution and implementation free – does not describe a technical solution or “How to”
- System requirements are used:
 - As the basis for considering and choosing a network architecture
 - To “accept” the system after rollout/deployment at end of a project
- Systems requirements are verified through
 - Demonstration
 - Test
 - Analysis
 - Inspection

Deriving System Requirements

By Unit

ERLANGS (Calls/Hr) x (Hr/Call)									
LOCATION		A	A	A	B	B	B	C	D
	UNIT	HQ	FIN	SAL	PM	ENG	R&D	MAN	PSTN
A	HQ	X	X	X	1	0.5	0.5	3	4
A	FIN	X	X	X	2	1	0.25	4	8
A	SAL	X	X	X	6	2	1	4	10
B	PM	1	1	6	X	X	X	4	1.5
B	ENG	0.5	0.5	2	X	X	X	6	4.5
B	R&D	0.25	0.5	0.15	X	X	X	0.25	2
C	MAN	1	4	3	4	3	0.1	X	10

Aggregated by
By Location into
“Traffic Matrix”

ERLANGS		TO			
	LOCATION	A	B	C	D
FROM	A	X	14.25	11	22
	B	11.9	X	10.25	8
	C	8	7.1	X	10

System Requirements are Solution Free

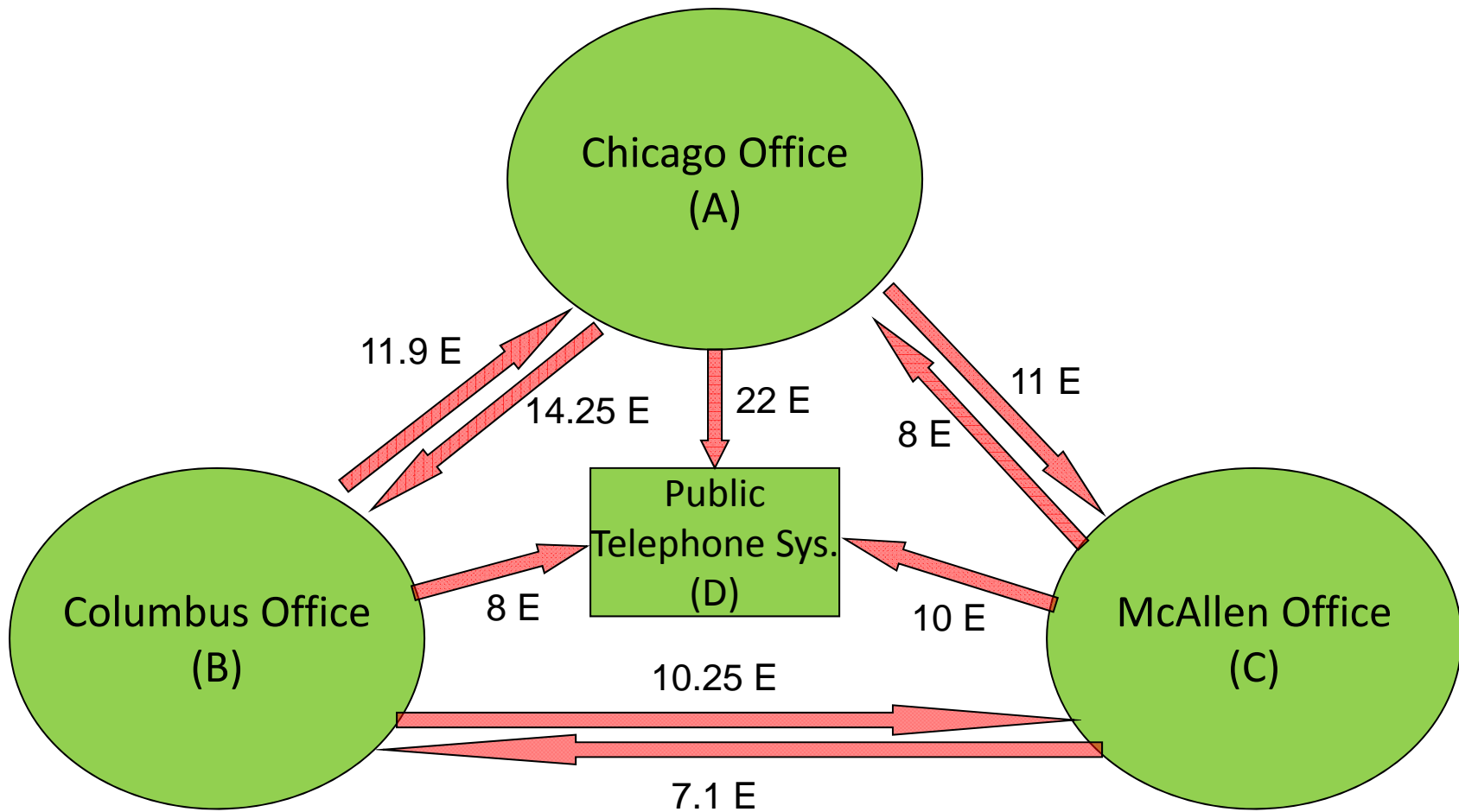

Network System Requirements are often “Embedded” in IT System Requirements

User Requirement: “Response to queries shall not negatively impact the ability of the financial analyst to process two loans per hour.”

IT System Requirement: “A characteristic user database query and response shall average 3-seconds, and not exceed 6-seconds, 95% of the time.”

Network System Requirement: “The time for a characteristic database query and response to traverse the network shall average 0.2-second and not exceed 0.4-seconds, 95% of the time.”

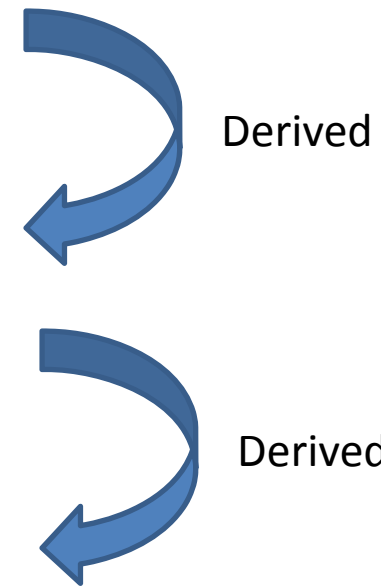

Example of Embedded Requirement

- Example: A user complains that the LAN is too slow, because it uses a 10Mbps Ethernet and takes too long to transfer large files (1MB) regularly used in the conducting business.
- The IT department asks the network group to upgrade the LAN to 100Mbps.
- The network manager asks for a demonstration by the user during the lunch hour when no one else is using the LAN or the Server and finds the transfer to take 12 seconds.
- Ignoring overhead bits from protocols, the network manager calculates that the file is transferred across the network in 0.8 seconds, as seen on next page.

Latency Estimates

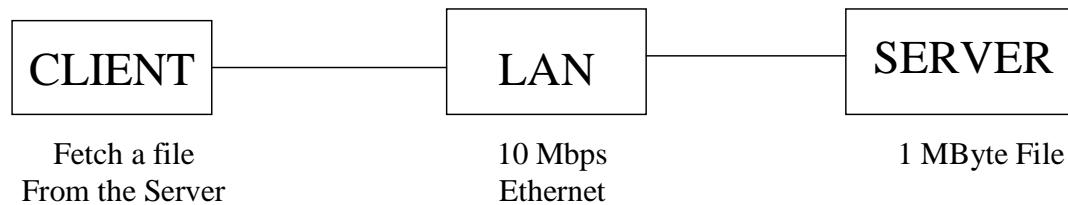

$$L_{\text{TOTAL}} = L_{\text{CLIENT}} + L_{\text{LAN}} + L_{\text{SERVER}}$$

$$L_{\text{LAN}} = \frac{\text{Volume (b)}}{\text{Capacity (b/s)}} = \frac{8 \text{ Mbits}}{10 \text{ Mbits/s}} = 0.8 \text{ S}$$

If L_{TOTAL} is observed to be 12s in the demonstration, then the network manager should recommend:

- a) Upgrading the LAN to 100 Mbps
- b) Upgrade the sever
- c) Upgrade the client

Characteristics of “Good” System Requirements

- **Complete** - defines which User Network Requirements will be satisfied
- **Consistent** in that one system requirement does not conflict with another
- **Correct** – no errors exist that will affect designing a solution
- **Clear** – there is only one possible interpretation
- **Traceable** – there is an audit trail to at least one user requirement
- **Verifiable** – able to show that the network meets the system requirement
- **Implementation Free** – does not describe a technical solution or “How to”

Tracing Requirements

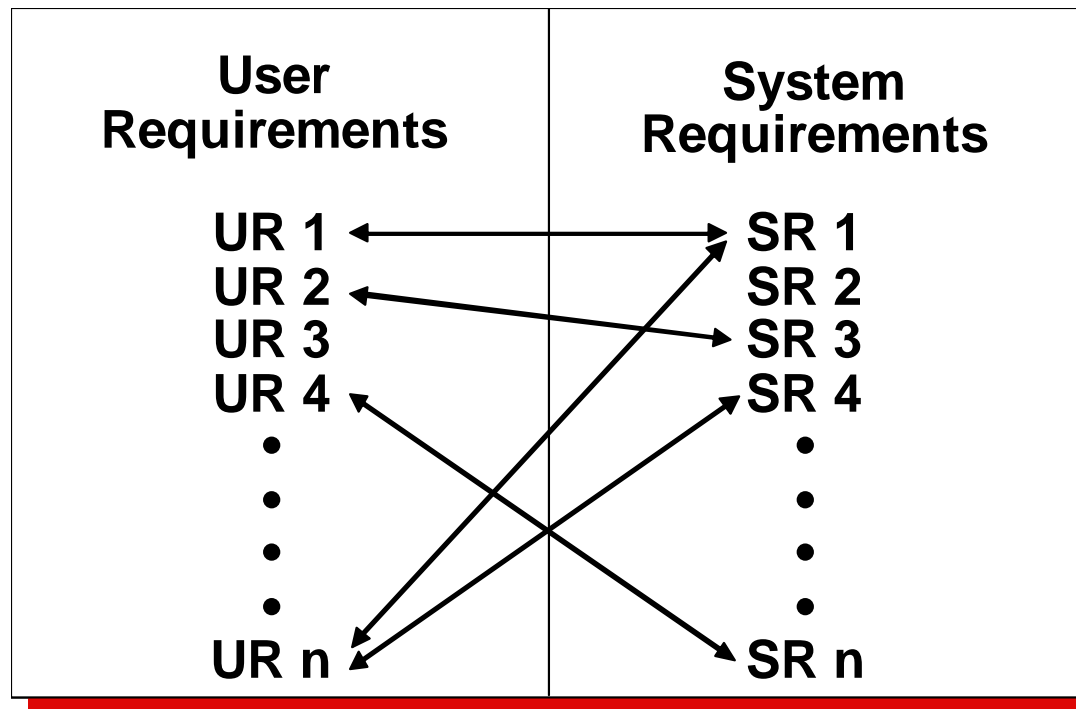

UR3 – missed requirement

SR2 – superfluous requirement

System Requirement Taxonomy

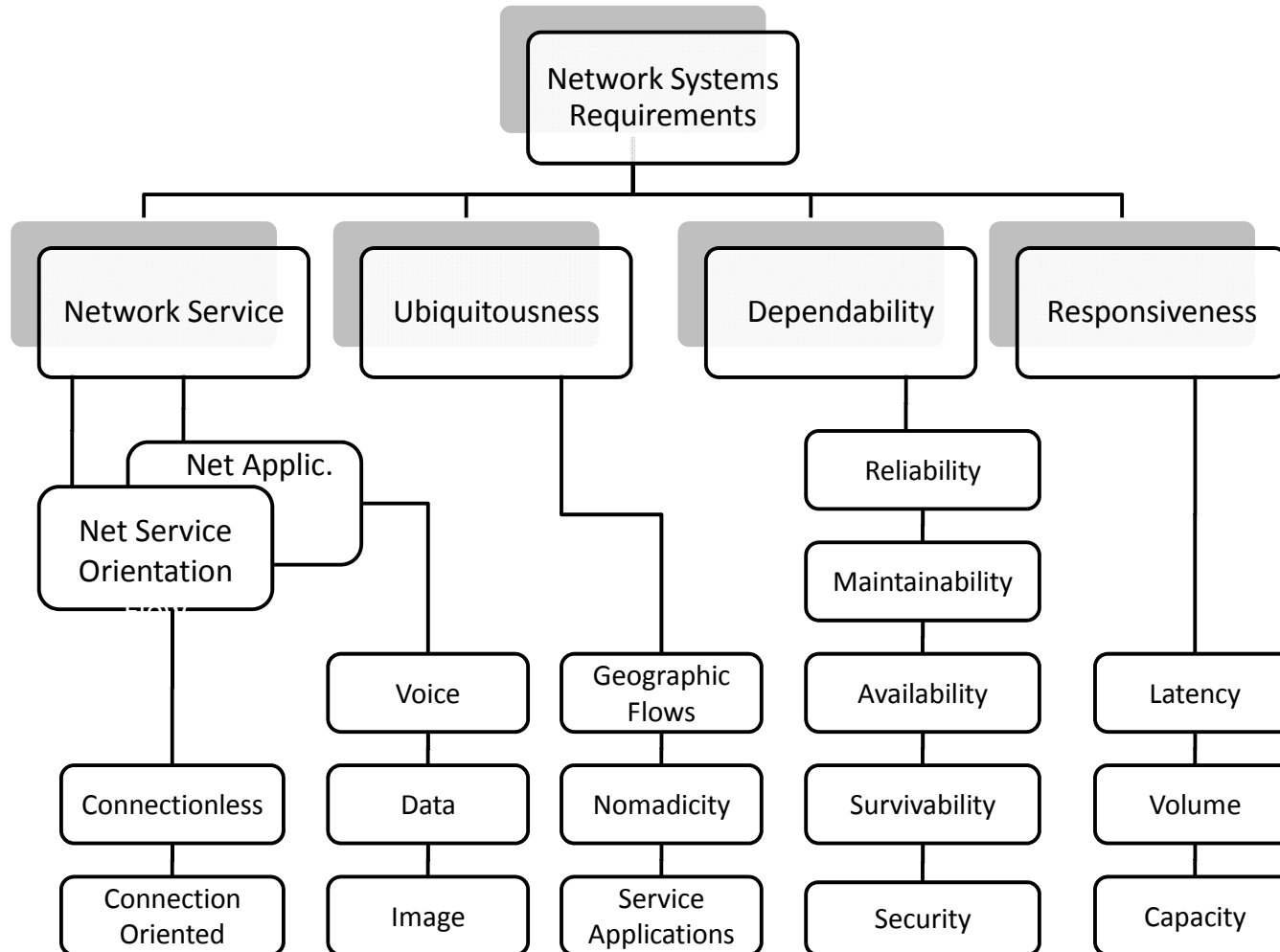

Network Ubiquity Requirements

- *Fixed Location*
 - At one physical location for the foreseeable future, such as a telephone in an office)
- *Migrant Location*
 - At one physical location while in use, but location can change, such as a laptop with wireless capability in a building)
- *Mobile Location*
 - Physical location subject to continuous movement, such as a cellular phone)

Reliability

$$R = e^{-\lambda \cdot t} = e^{-t / MTTF}$$

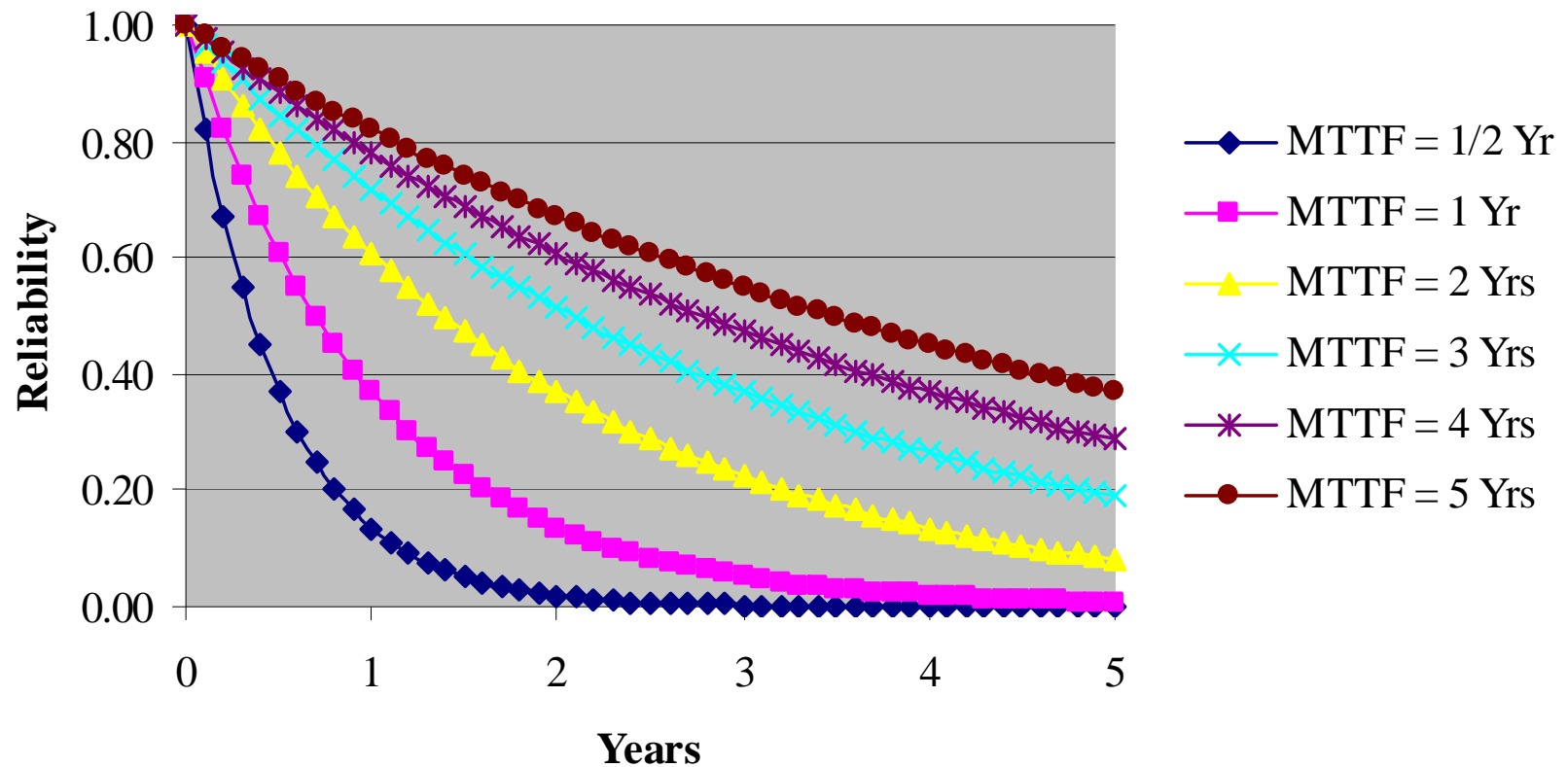

Reliability Examples

- Reliability Example 1:

- What is the chance a local telecommunications switch with an MTTF of 5 years will operate without failure for 5 years?

$$R_{5-Yrs} = e^{-\lambda \cdot t} = e^{-t/MTTF} = e^{-5/5} = e^{-1} = 0.368$$

- Reliability Example 2:

- What is the chance a switch with an MTTF of 5 years will operate without failure for 1 years?

$$R_{1-Yrs} = e^{-\lambda \cdot t} = e^{-t/MTTF} = e^{-1/5} = e^{-0.2} = 0.818$$

- Reliability Example 3:

- What is the chance a switch with an MTTF of 5 years will operate without failure for 1 week?

$$R_{2-Yrs} = e^{-\lambda \cdot t} = e^{-t/MTTF} = e^{-(1/52)/5} = e^{-0.00385} = 0.996$$

Maintainability

- Service Maintainability is the chance a failed service will be restored by a specified period of time

$$M = 1 - e^{-\mu \cdot t} \quad u = \frac{1}{MTTR}$$

- Maintainability Example

- A DS3 digital circuit has an MTTR of 12 minutes. What is the chance the DS3 will be recovered for use in 1 minute?

$$M_{1-Min} = 1 - e^{-\mu \cdot t} = 1 - e^{-t/MTTR} = 1 - e^{-1/12} = 1 - e^{-0.0833} = 0.080$$

Availability

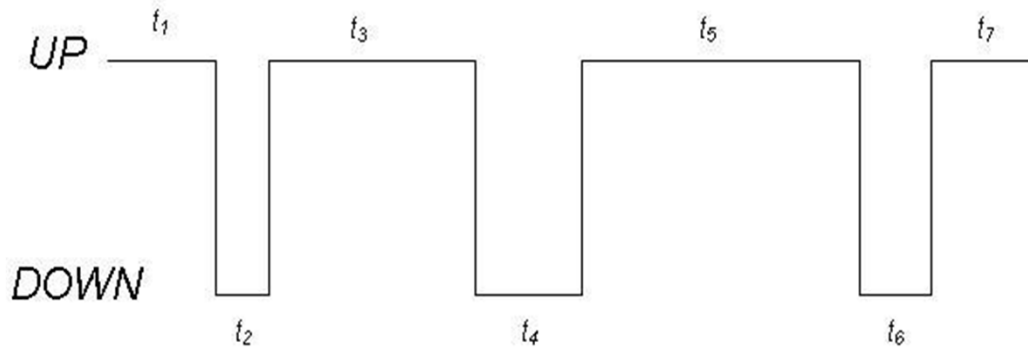

Historical

$$A = \frac{UPTIME}{INTERVAL_TIME}$$

Predictive

$$A = \frac{MTTF}{MTTF + MTTR}$$

Predictive Availability Example

- A telecommunications service has an MTTF of 620 hours and an MTTR of 30 minutes.
- What is the availability of the service? How many hours per quarter can we expect the service to be down?

$$A = \frac{MTTF}{MTTF + MTTR} = \frac{620}{620.5} = 0.99919$$

$$U = 1 - A = 0.00081$$

$$Down_Time = 0.00081 \cdot 24hrs \cdot 30day \cdot 3months = 1.74Hours$$

Availability

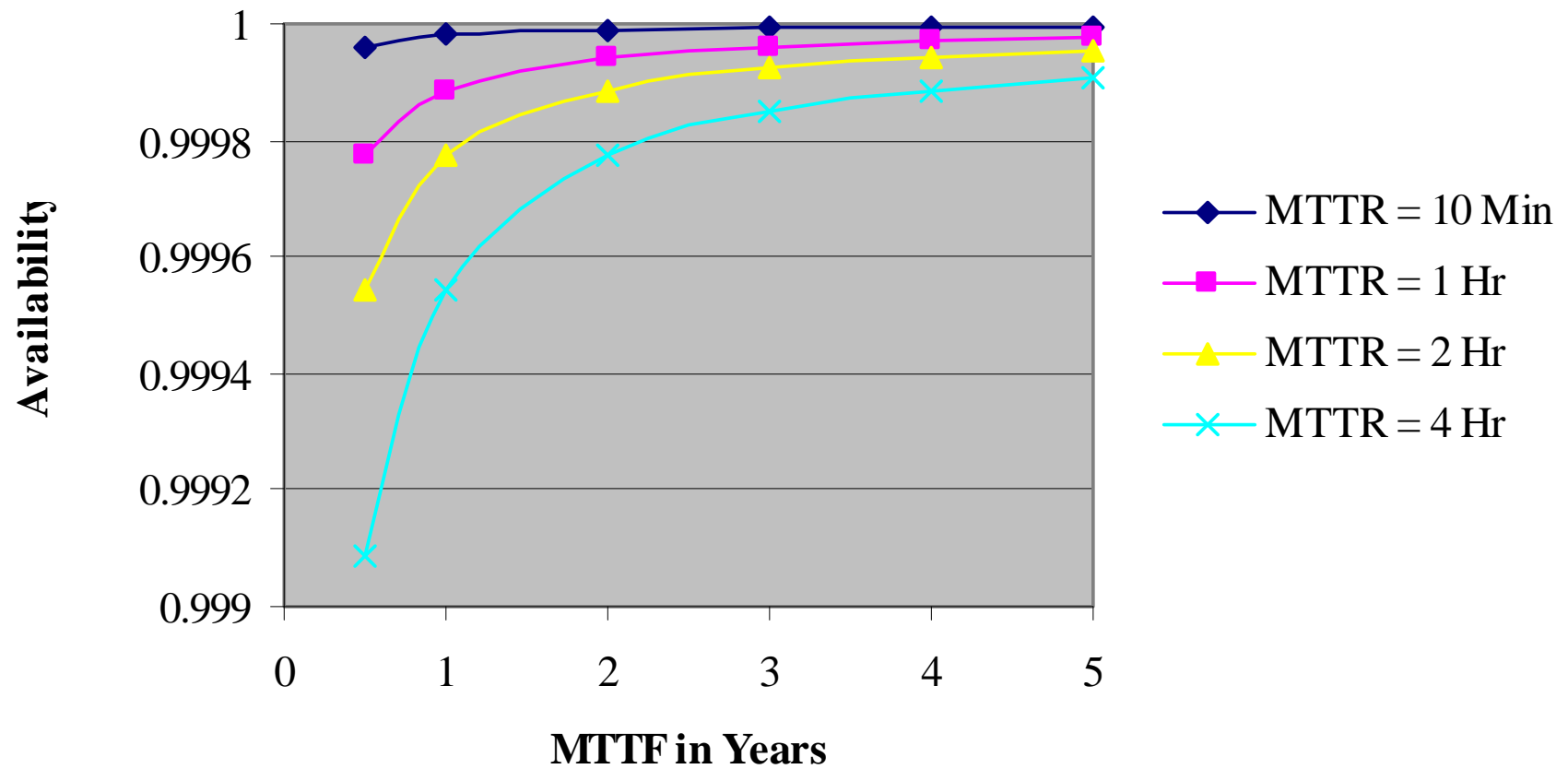

Outage Profile

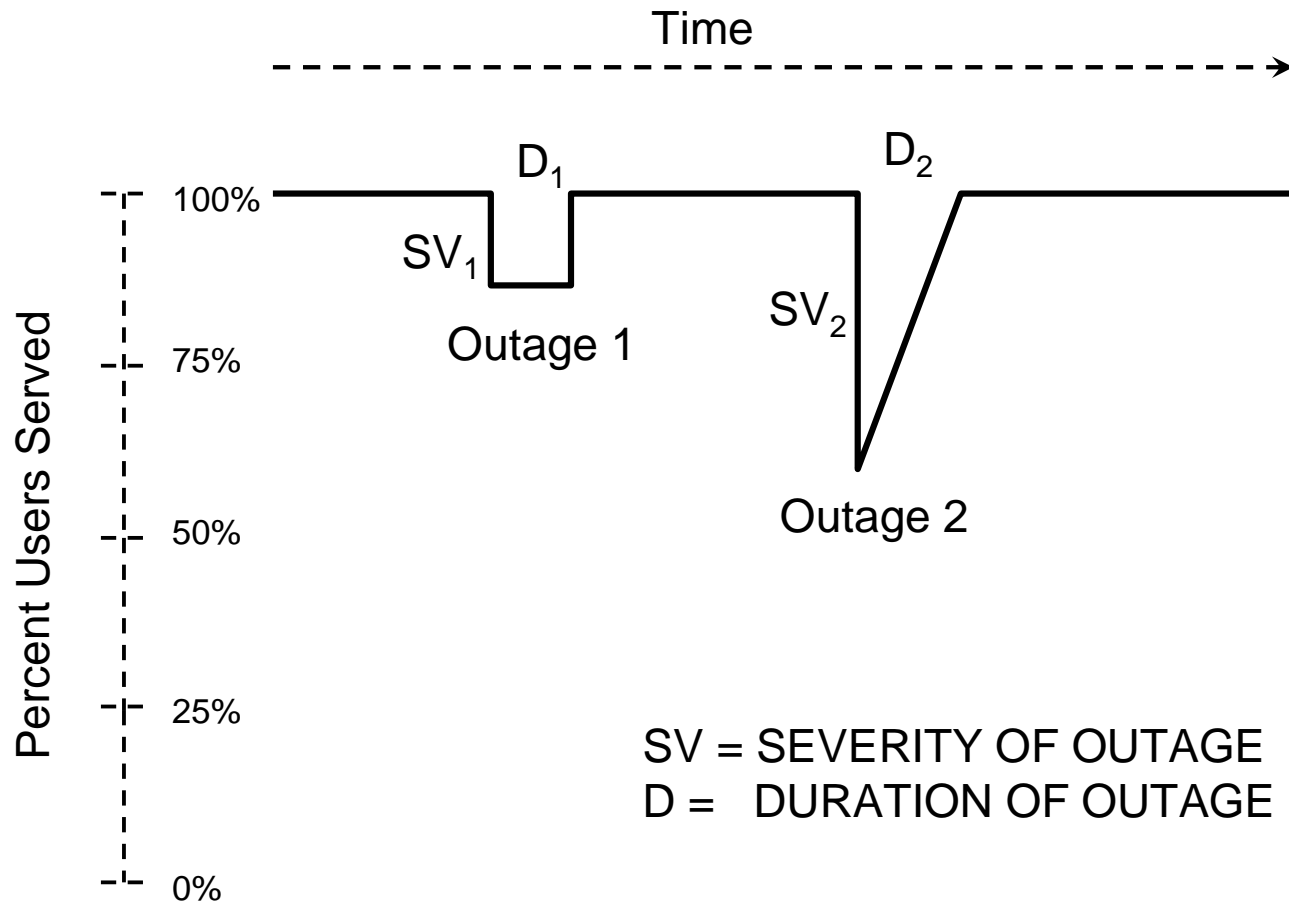

Survivability

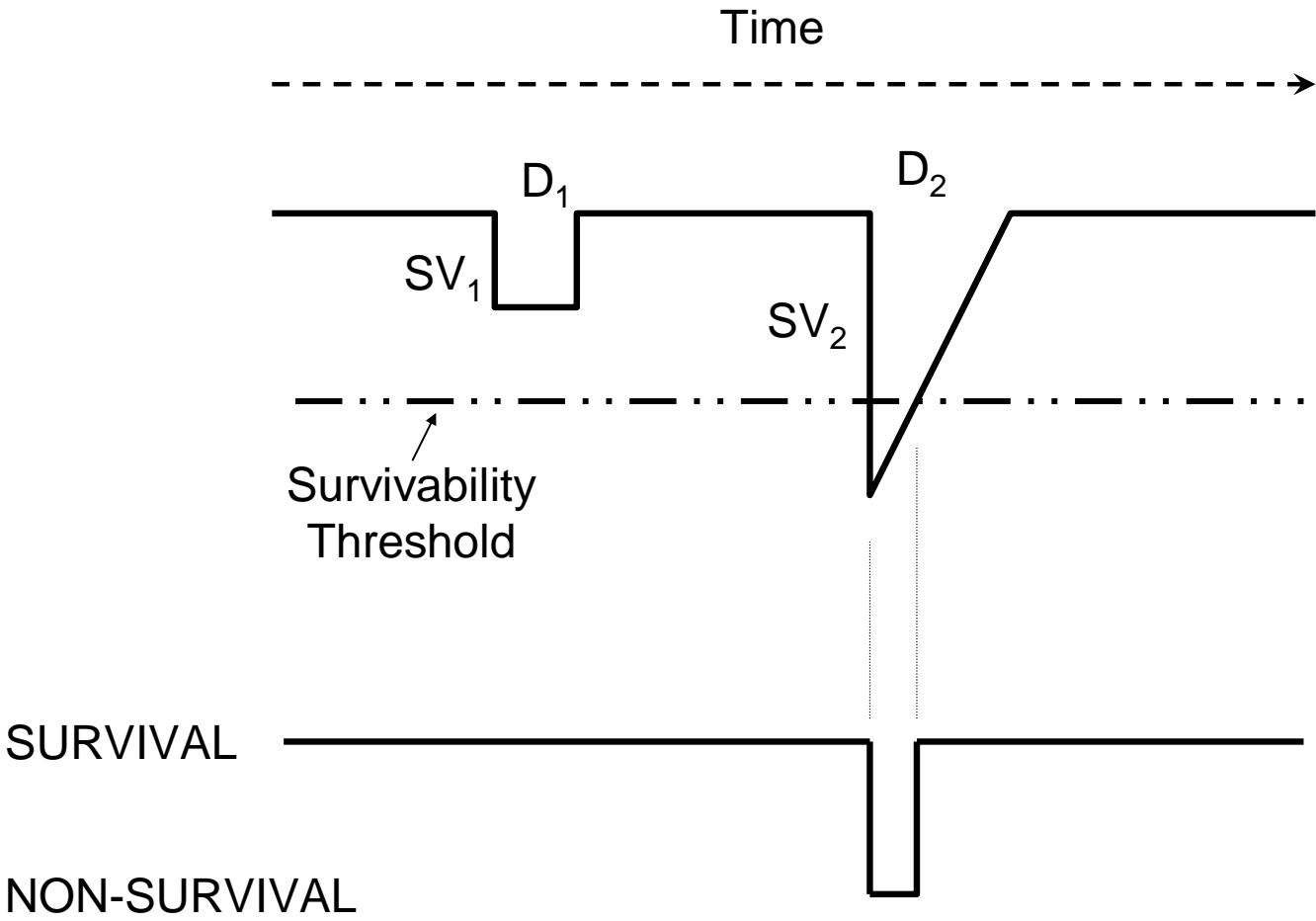

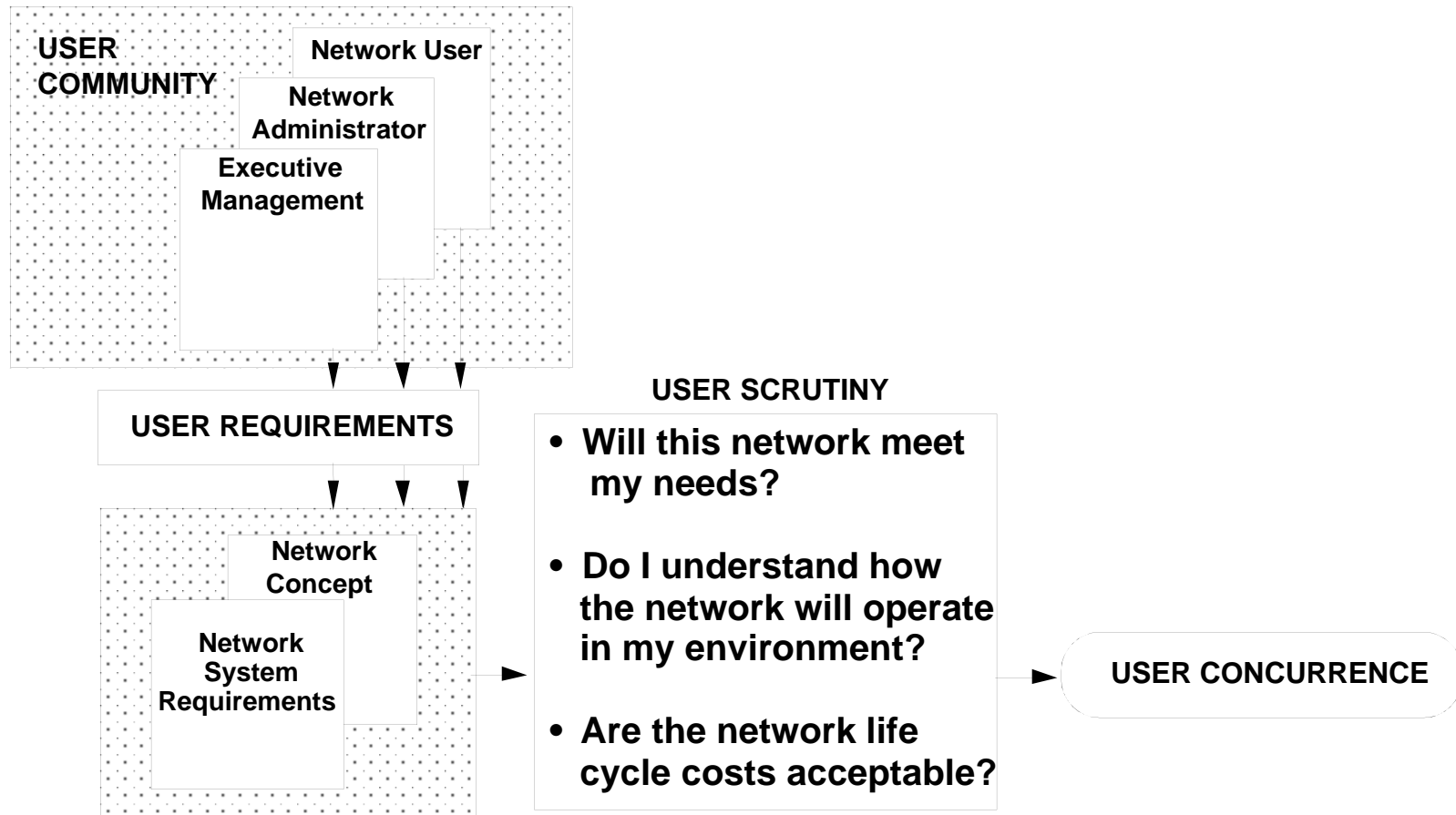

Network Concept Definition

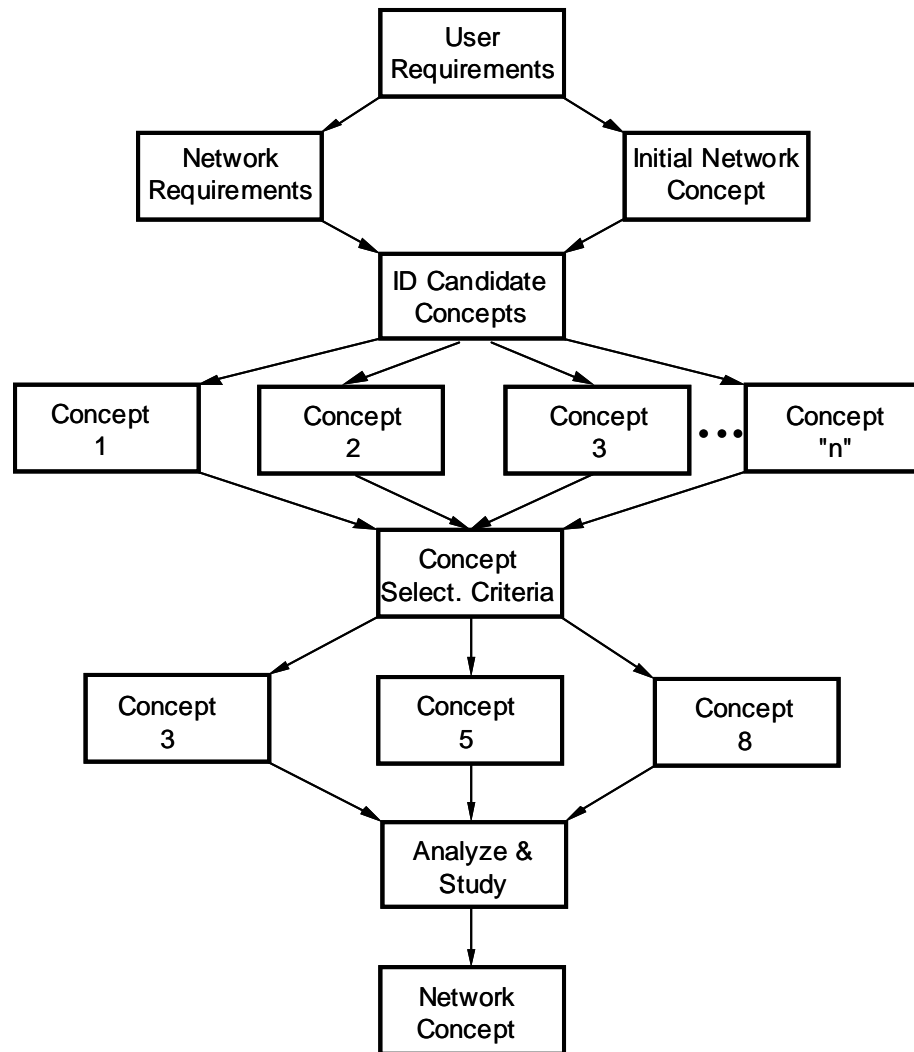

Objective: Pick the “Best Approach”



Lifecycle Skills Mix

	Skill Type	Comfort With Uncertainty	Risk Taking Ability	Attention To Detail
	<i>Network Innovator</i>	High	High	Low
	<i>Network Implementer</i>	Medium	Medium	Medium
	<i>Network Refiner</i>	Low	Low	High

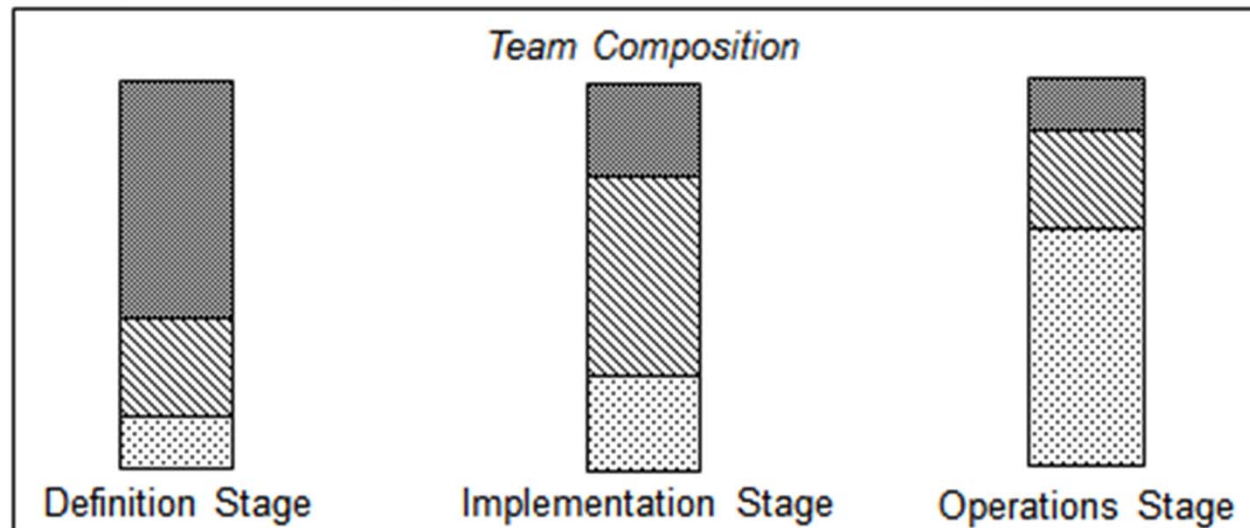

A Network System Perspective

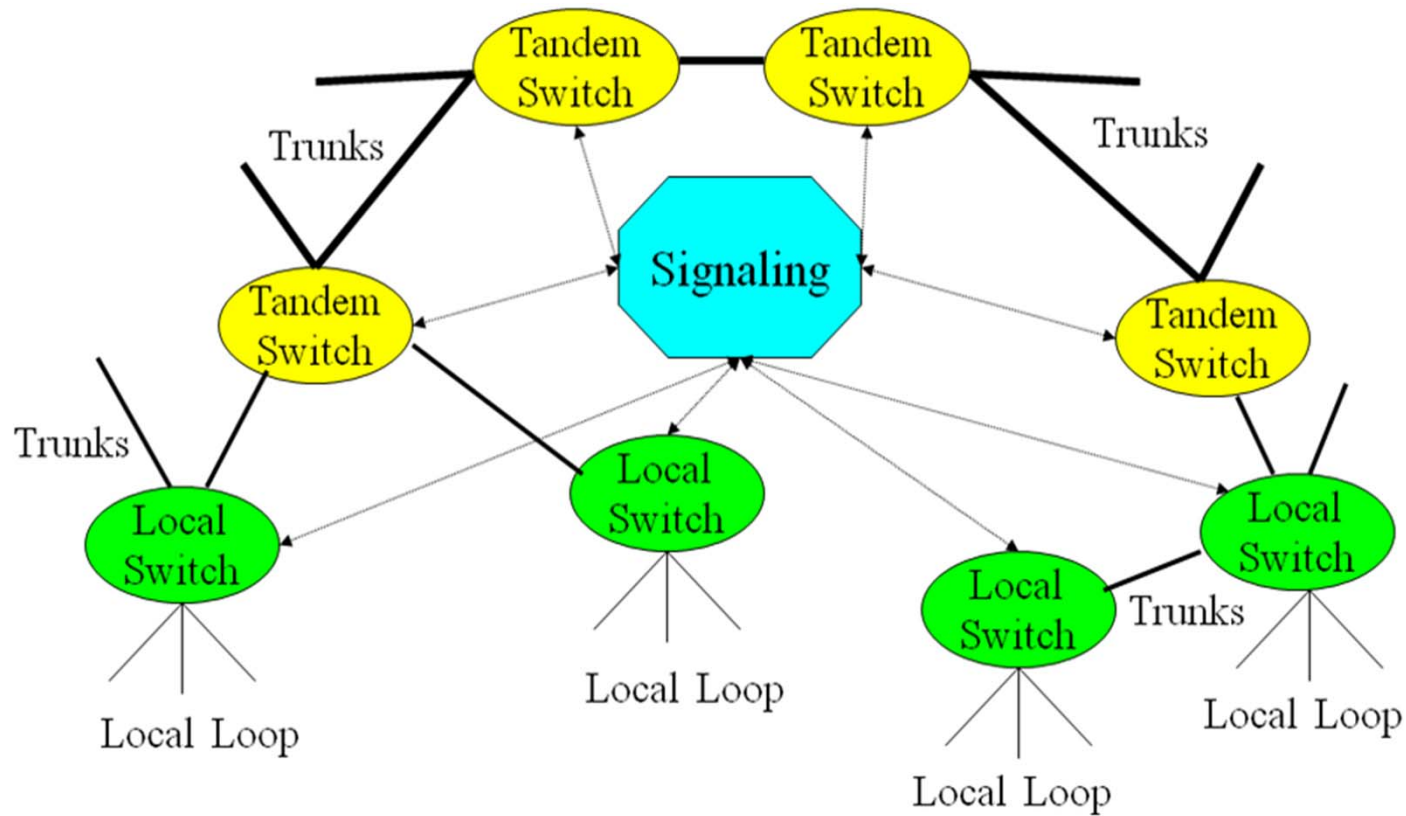

Another Network System Perspective

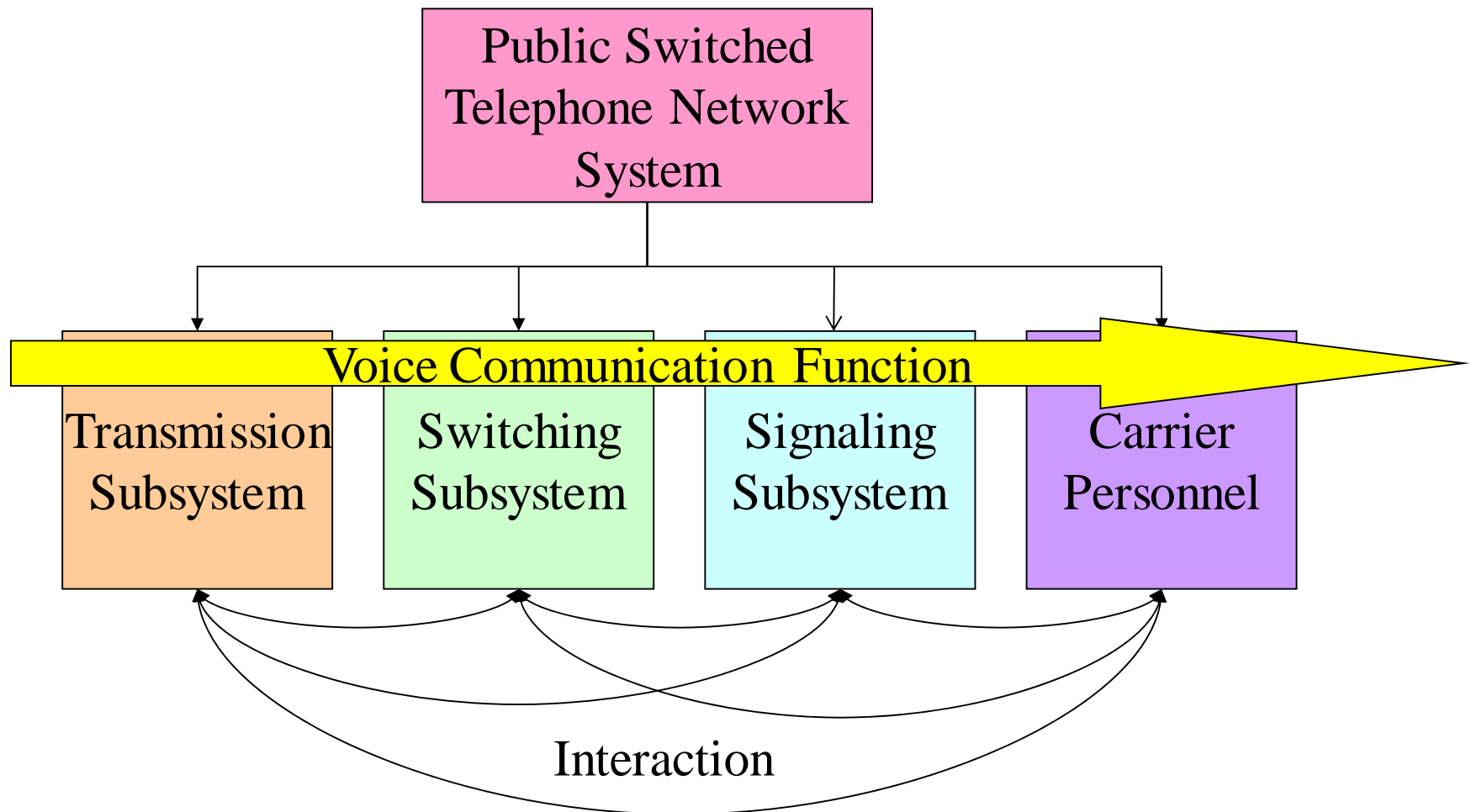

Network System Decomposition

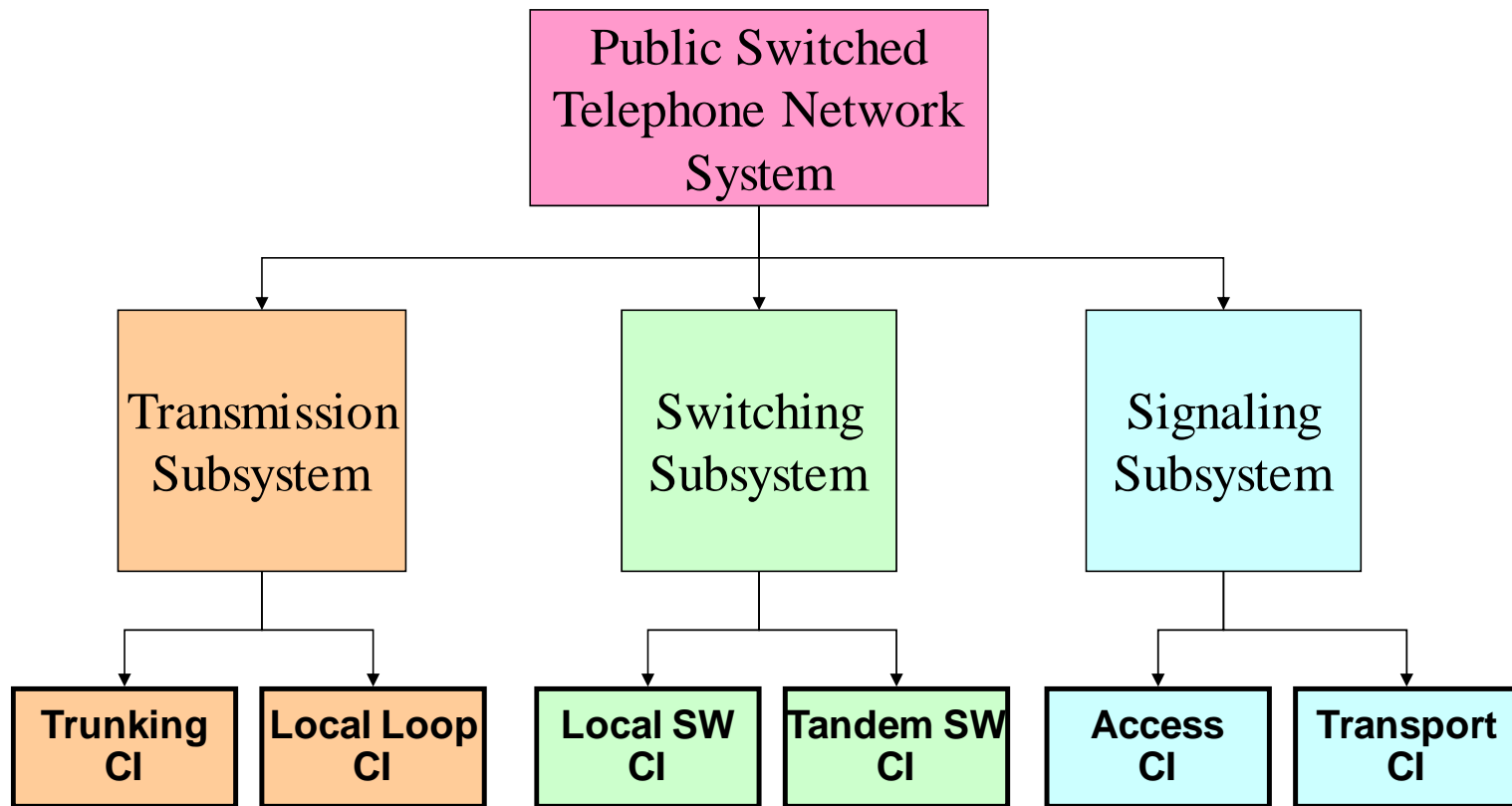

Network Concept

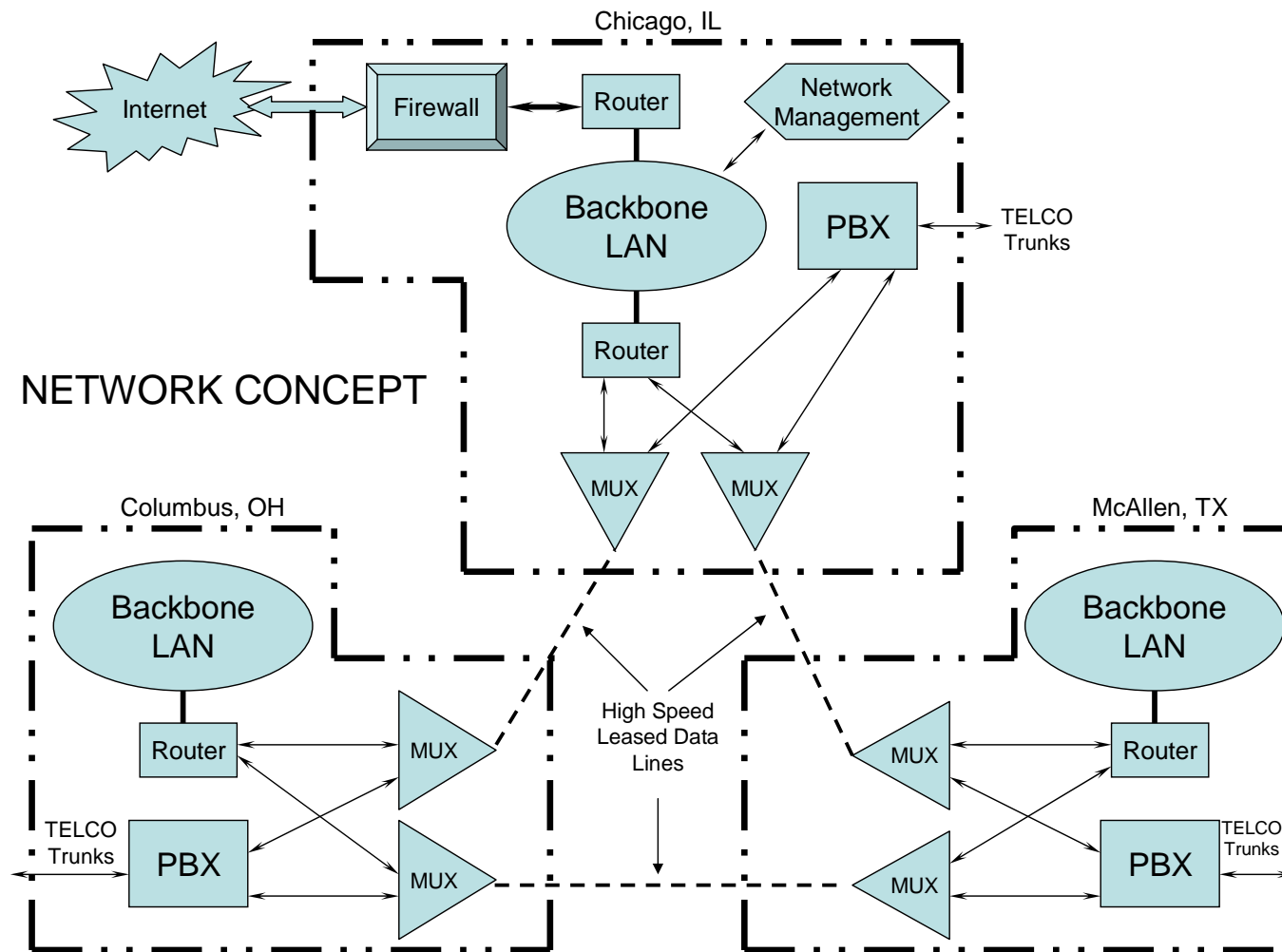

Linking Equipment Specs to User Requirements

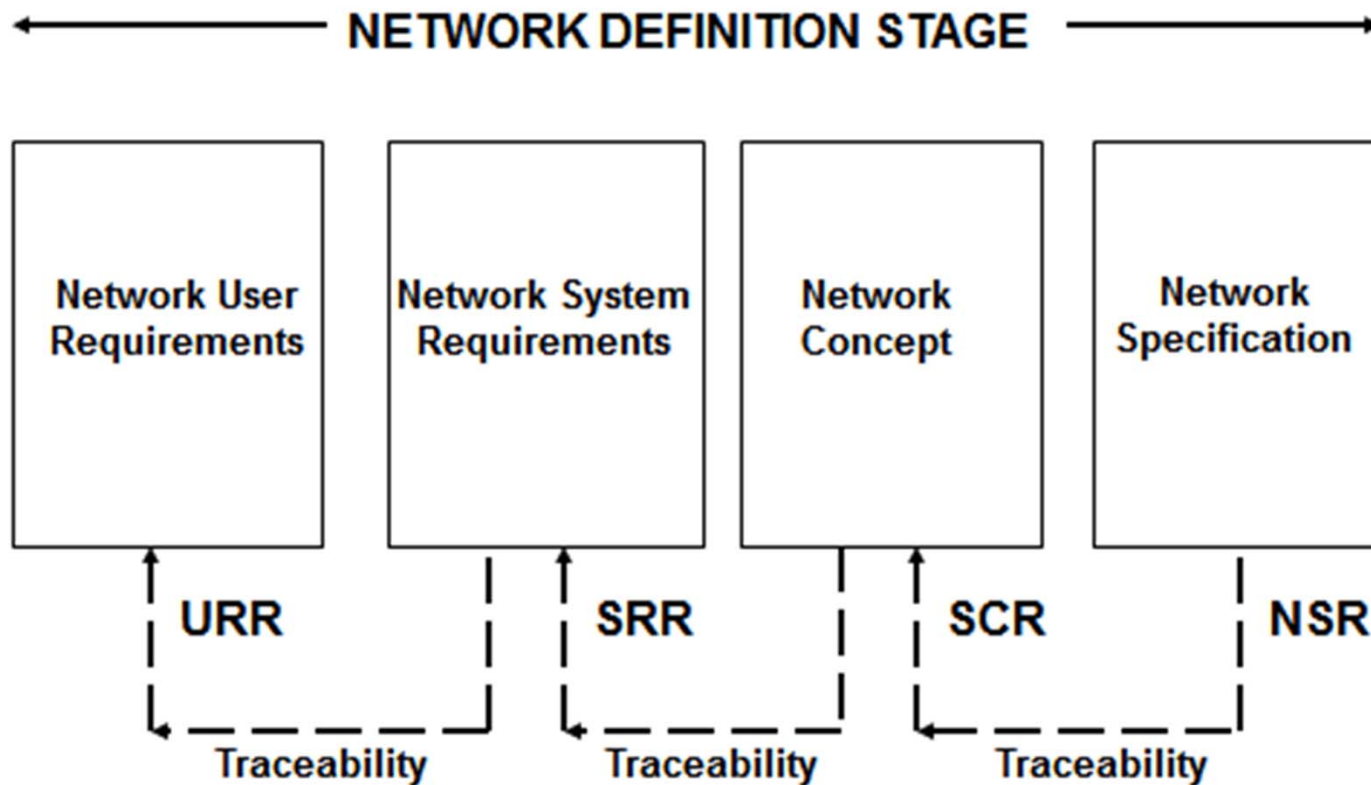

Specifying Equipment Reliability and Maintainability

CI	MTTF (hours)	MTTR (hours)	Availability
User Station	35,040	0.25	0.999992865
Voice Wiring	87,600	1	0.999988585
PBX	87,600	1	0.999988585
Multiplexer	64,560	1	0.999984511
Leased Line	8,760	0.1	0.999988585
Multiplexer	64,560	1	0.999984511
PBX	87,600	1	0.999988585
Voice Wiring	87,600	1	0.999988585
User Station	35,040	0.25	0.999992865
Voice Call Availability			0.999904814

SR = **0.9999**

Allocating Sys Requirements to Equipment Specs

Network System

Network System Requirement

Network Subsystem

Network Configuration Item

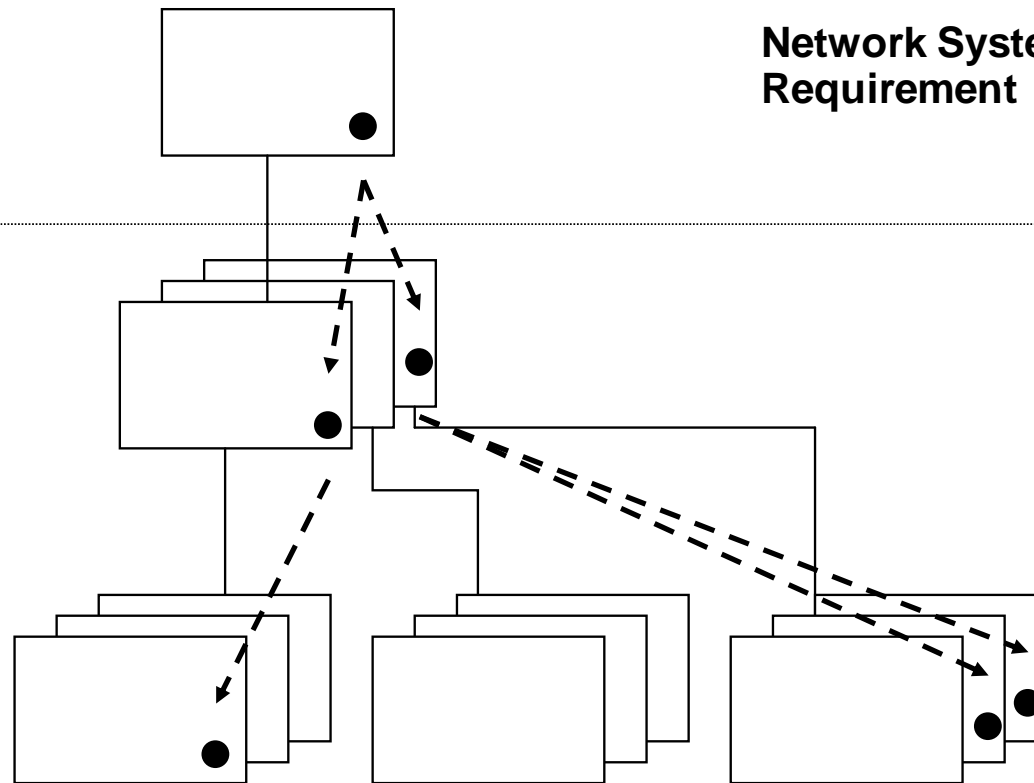

SR Allocation Illustration

User Requirements	UR 53: The Network Operator shall be able to monitor Usage on the network	
Net. System Requirements	SR 92: The network administrator shall be alerted within 10 sec. whenever traffic exceeds an operator selected threshold.	
Network Specs	<ol style="list-style-type: none"> 1. Router CIs shall have SNMP capability 2. The Net Mgt server CI shall have SNMP capability 3. The Net Mgt server CI shall have SNMP MIB capability 4. The Net Mgt server CI shall send alerts to the console 5. The Net Opns Console CI shall display alerts in red 	Network Definition Stage
CI Design Specs	Part of Network Implementation Stage	

Planning Phase

- A complete plan includes the following:
 - Tasks/subtask definition
 - Schedule/milestones for tasks/subtasks
 - Resources required for each task/subtask
 - Responsibility for each task/subtask
- Proceed at your own hazard without a complete plan!

Planning – First Define the Necessary Work

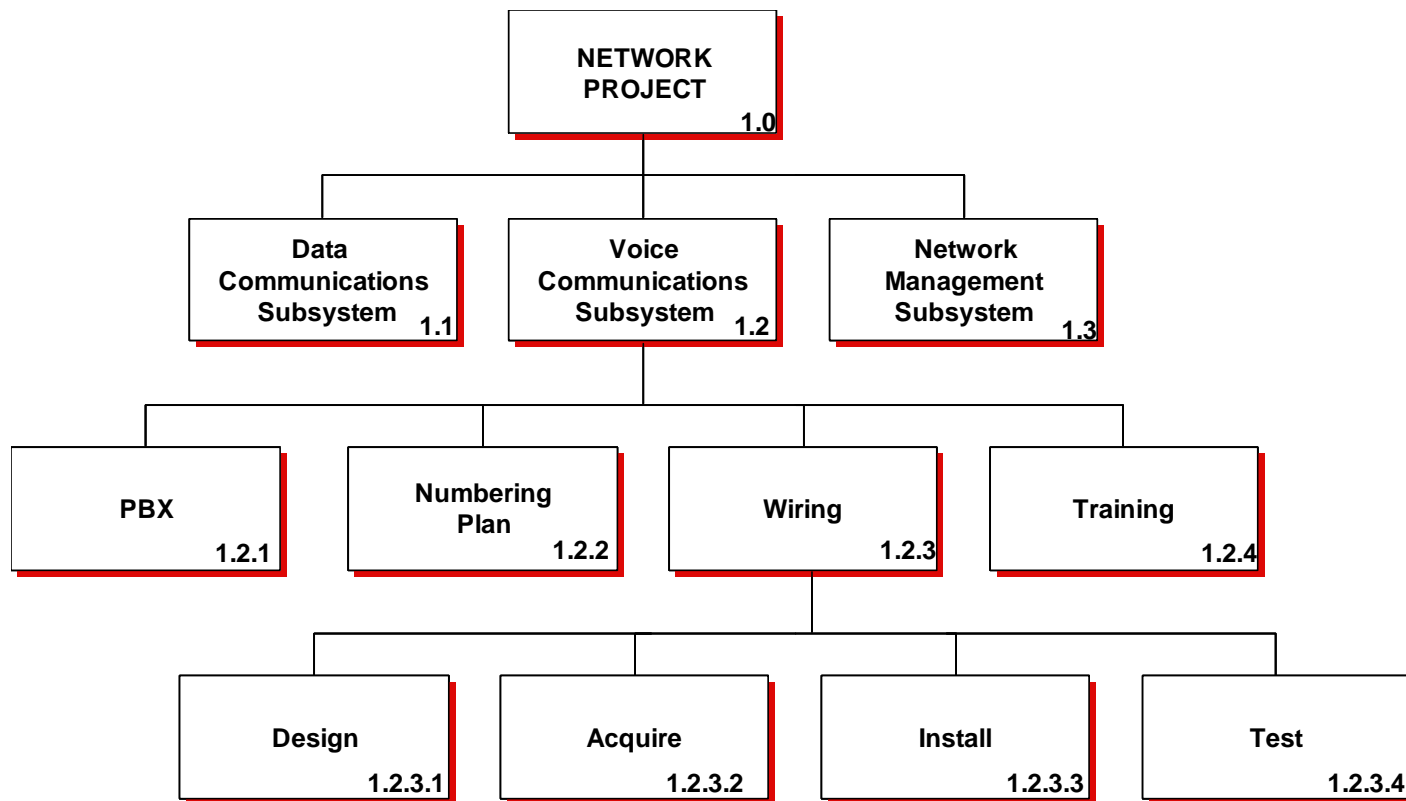

Developing Gantt and Critical Path Schedules

ID	WBS	Task Name	Month 1				Month 2				Month 3				Month 4				M			
			2	9	16	23	30	6	13	20	27	4	11	18	25	1	8	15		22	29	
1	1.	NETWORK PROJECT	[Gantt bar from 2/2 to 4/15]																			
2	1.2	Voice Communications	[Gantt bar from 2/2 to 4/8]																			
3	1.2.1	PBX	[Gantt bar from 2/16 to 3/25]																			
4	1.2.2	Wiring	[Gantt bar from 2/2 to 2/20]																			
5	1.2.2.1	Create Design	[Gantt bar from 2/9 to 2/16]																			
6	1.2.2.2	Acquire Materials	[Gantt bar from 2/23 to 3/6]																			
7	1.2.2.3	Install Wiring	[Gantt bar from 3/13 to 3/20]																			
8	1.2.2.4	Perform Testing	[Gantt bar from 3/27 to 4/3]																			
9	1.2.2.5	Acceptance Review	[Gantt bar from 4/10 to 4/17]																			
10	1.2.3	Numbering Plan	[Gantt bar from 2/2 to 3/11]																			
11	1.2.4	Training	[Gantt bar from 4/1 to 4/8]																			

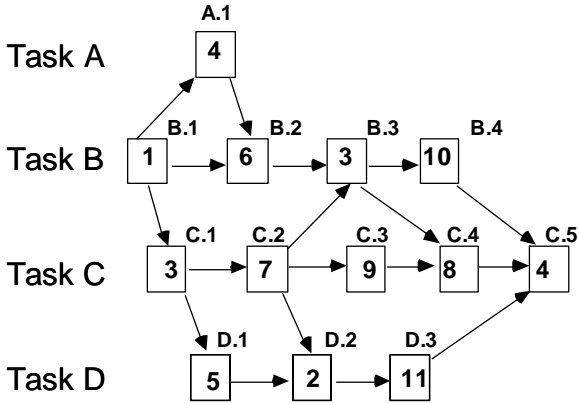

Hierarchical Schedules

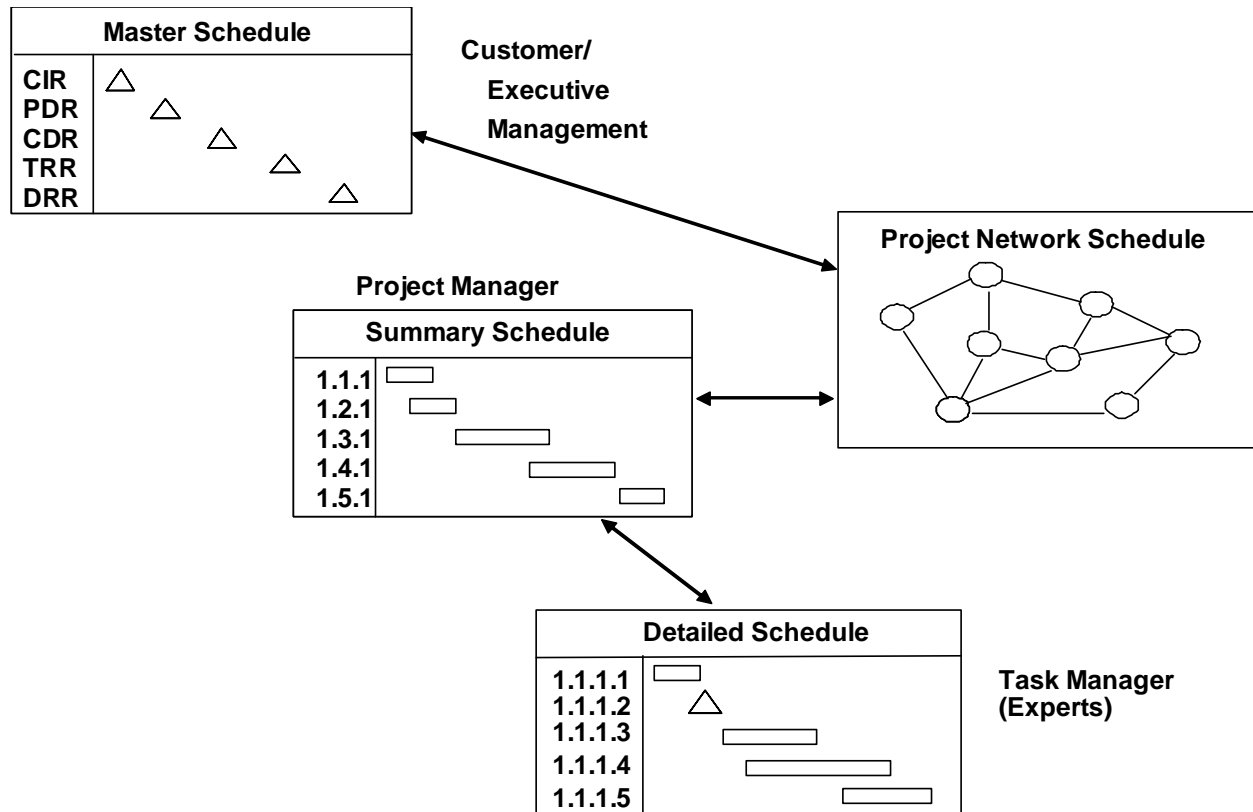

Identifying Who is Responsible for Work

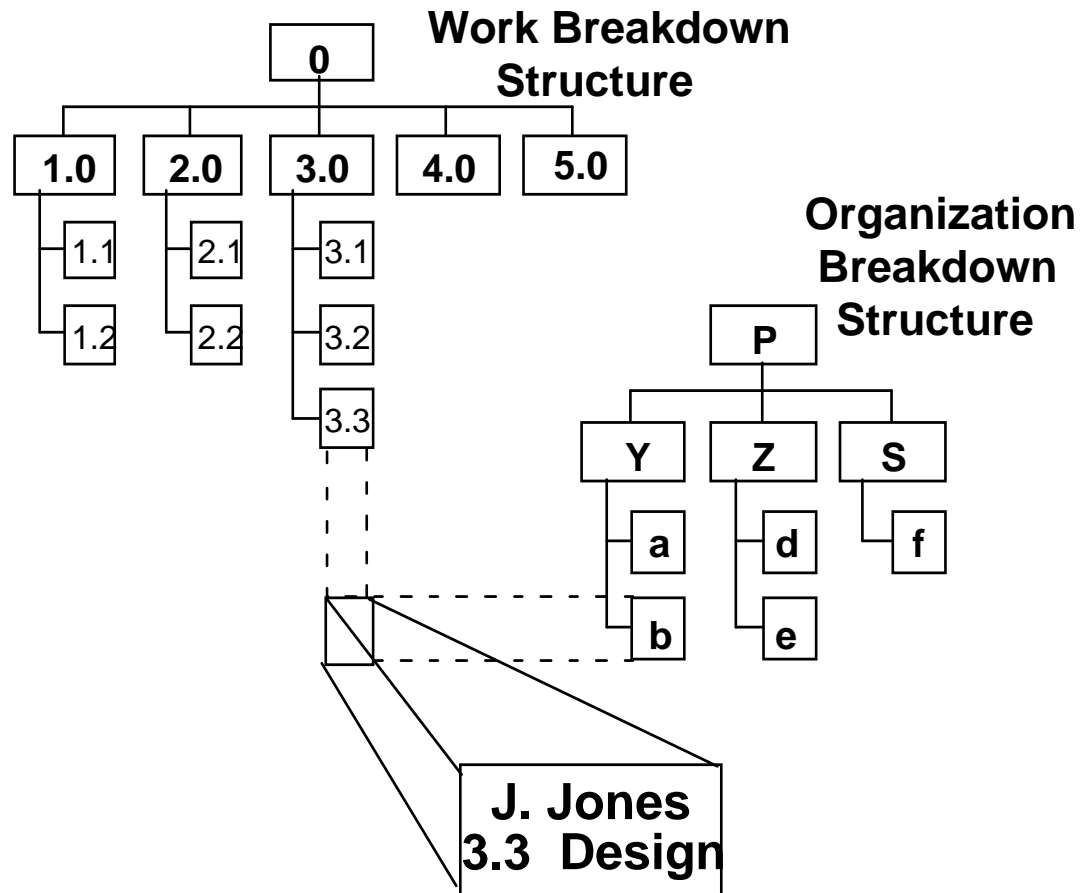

Estimating Cost of Project

- Labor: Categories, level of expertise, hours required, hourly price
- Materials: Equipment, software, raw materials, tools and non-consumable supplies
- Other Costs: Travel, reproduction, consumable supplies

Implementation Stage

- Network Source Selection: Acquire external resources (services/products)
- Network Design: Develop a detailed network design to allow network integration and deployment/rollout
- Network Integration: Build, configure, integrate, test, and stage network equipment in preparation for network deployment/rollout

Network Implementation Stage

STAGES & PHASES	NETWORK IMPLEMENTATION STAGE					
	Network Source Selection Phase		Network Design Phase		Network Integration Phase	
MAJOR ACTIVITIES	Prepare Request for Proposal(s)	Evaluate Proposals	Update Network Implementation Plan	Prepare "Design-to" Specifications	Prepare "Build-to" Specifications	Assemble/Config. Equipment
		Select Vendor(s)				
	Prepare Request for Quote(s)	Negotiate Contract(s)	Identify Resources	Update Verification Plan	Verify Design meets Performance Reqts	Prepare Network Maintenance Manuals
			Commit Resources			
	Develop Evaluation Plan			Develop Network Integr. Approach	Prepare Verification Procedures	Prepare Network Opns Manuals
				Develop Network Deployment Approach	Conduct Pilot(s)/ Create Prototype(s)	Perform Testing
PRODUCTS	RFPs	Signed Contract(s)	Revised Network Implementation Plan	Network "Design-to" Specifications	Network "Build-to" Specifications	Maintenance Manuals
	Proposal RFP Evaluation Plan		Project Team Assignments	Verification Plan	Traceability Matrix	Operations Manuals
	Equipment RFQs			Network Integration Plan	Verification Procedures	Test Results
				Initial Network Deployment Plan	Pilot(s)/Prototype(s)	Final Network Deployment Plan
CONTROL GATES	Proposal Evaluation Review (PER) ▲	Contract Award Review (CAR) ▲	Network Project Implementation Review (PIR) ▲	Network Prelim Design Review (PDR) ▲	Network Critical Design Review (CDR) ▲	Test Rediness Review (TRR) ▲

Negotiated Procurements

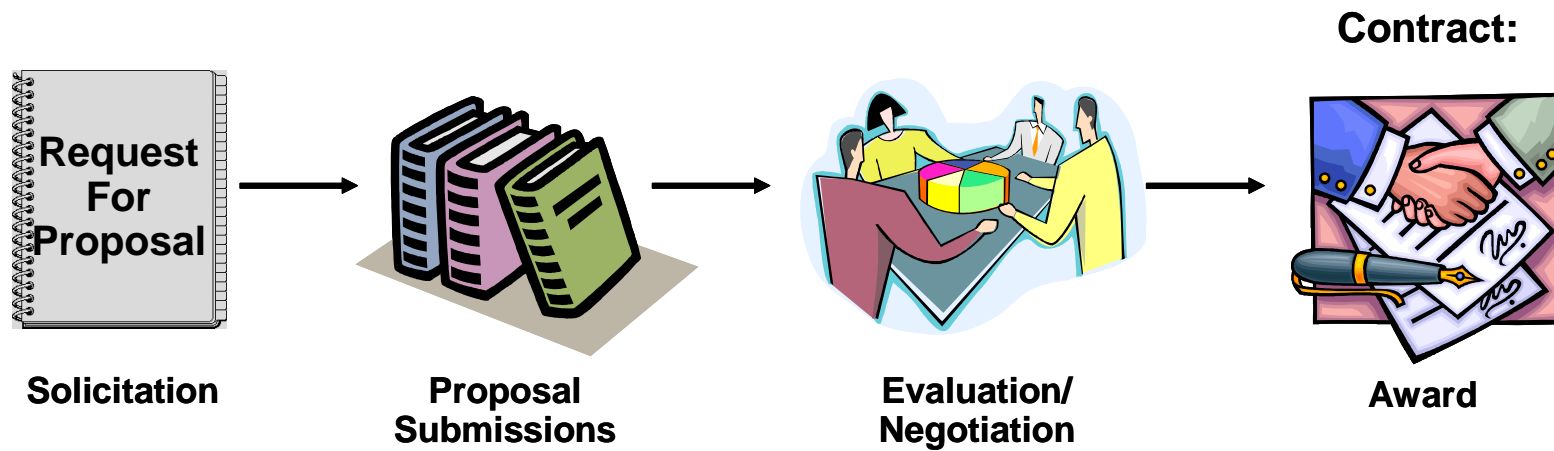

Solicitation Vocabulary

- Solicitation – Request for Proposal (RFP)
- Buyer – the customer or client who issues the RFP desiring systems and services
- Seller – the firm or group of firms responding to the RFP, also called the “supplier” or “bidder”
- Prime Contractor – the lead firm for the proposed system/ services who is to be legally responsible to the buyer for the required system/services, and who will manage the effort if there is a win. Sometimes referred to as the “Integrator”.
- Subcontractor – a firm responsible to the prime for a portion of the buyer’s system and/or services.
- Vendor – a firm providing equipment to a prime or subcontractor.
- Incumbent – firm(s) already performing work or providing equipment for/to the buyer which is identical, or similar, to that requested in the RFP.
- Bid-No Bid Review – a control gate used by a prospective bidder to decide whether to bid on an RFP or not
- Red Team Review – a control gate used by a prospective bidder to insure the proposal is compliant, responsive and competitive.

Design in the Lifecycle

User Requirement	Data transfer between Columbus OH and McAllen TX
System Requirement	Peak Information Transfer Rate (ITR) of 985 Kbps between Columbus and McAllen
Network Concept Phase	High speed digital line between Columbus and McAllen, a major component
Specification Phase	DS1 digital circuit (1.544 Mbps) between Columbus and McAllen
Source Selection Phase	Vendors selected
Design Phase	DS1 line from Verizon Columbus: 386 High Street Suite 1100, Rm 101 McAllen: 525 Main St., Suite 200, Rm 21

Preliminary Design Example

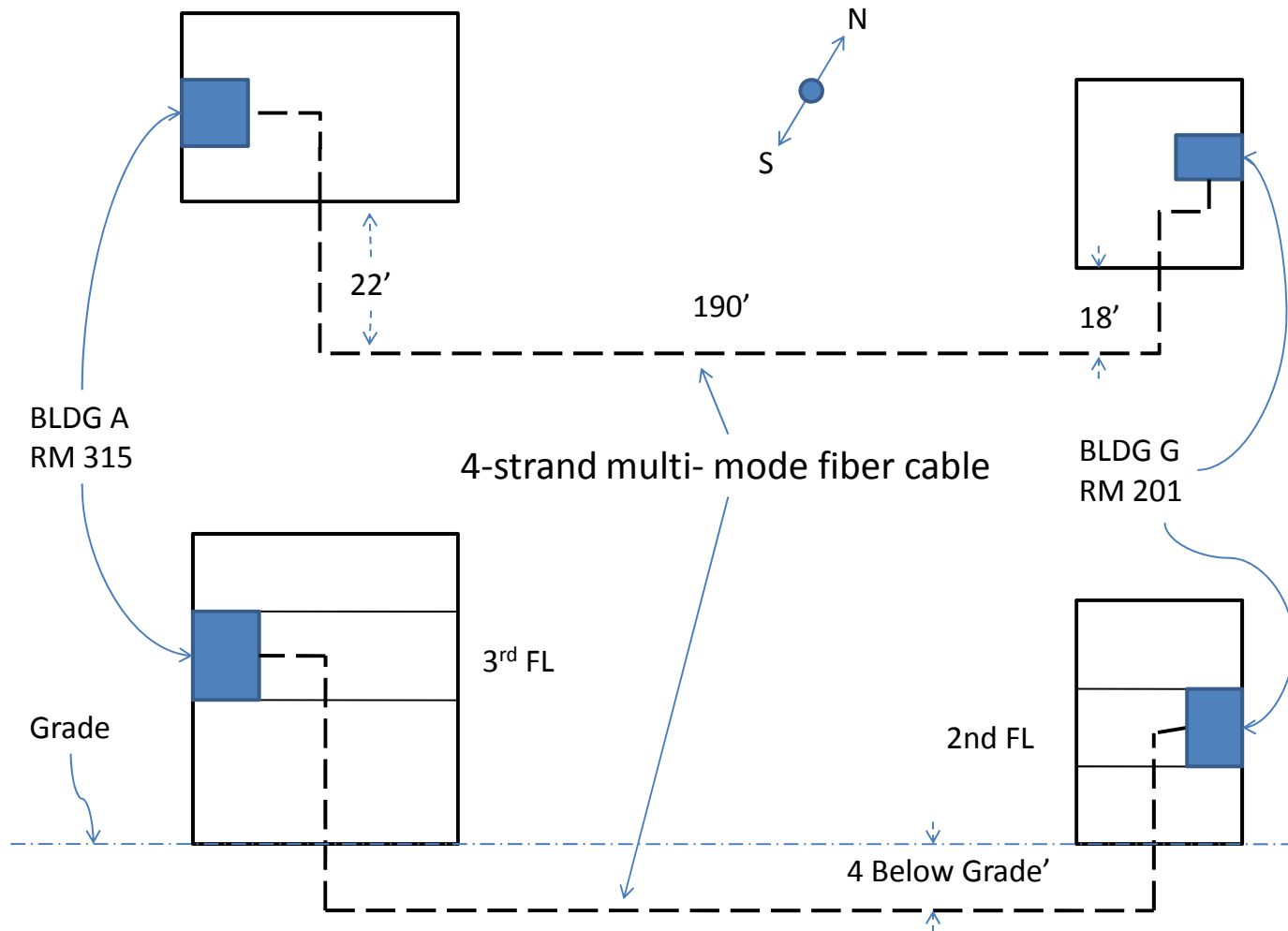



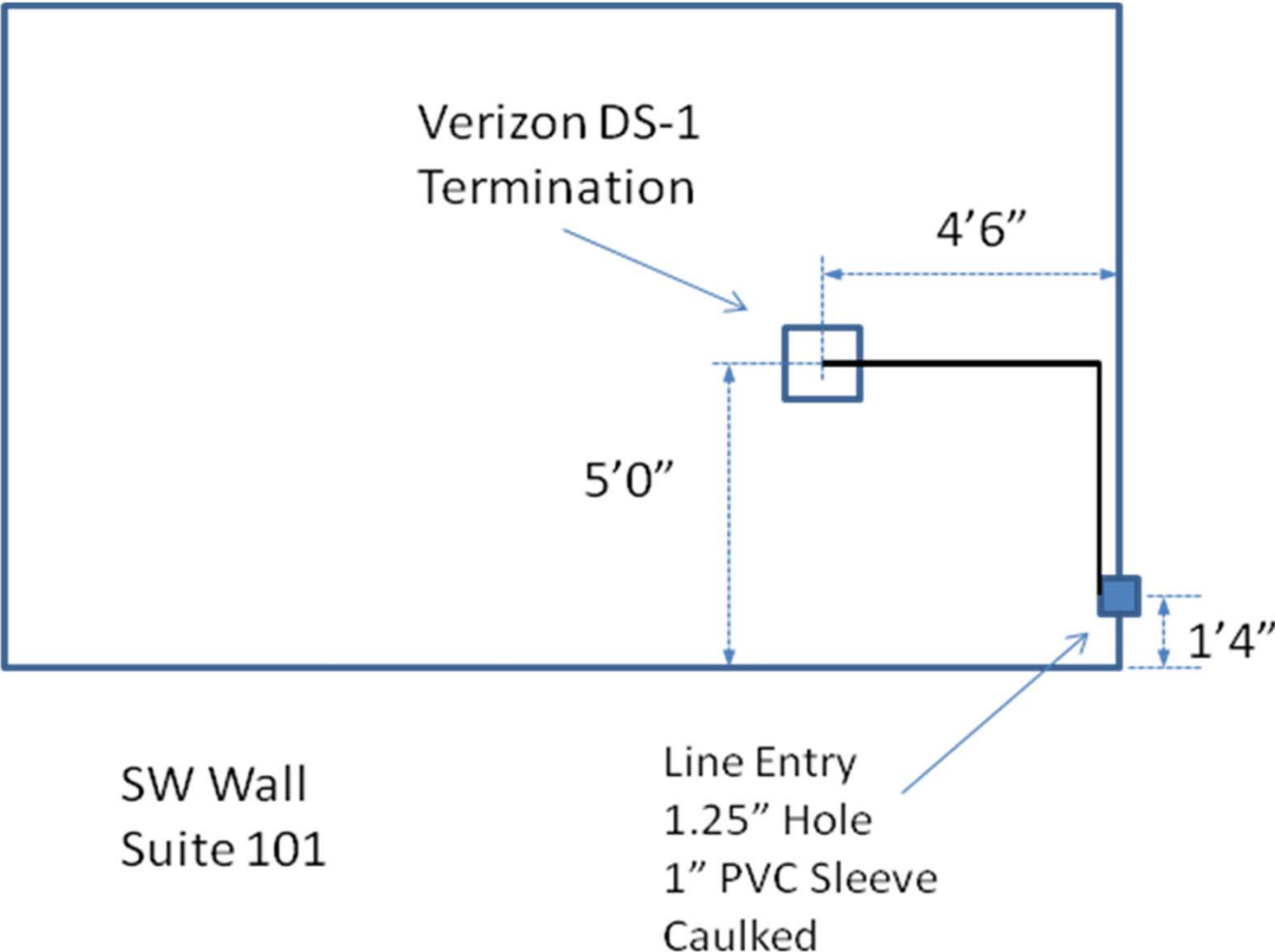

Network Systems Integration

- Perform critical design
- The purpose of the network integration phase is also to
 - Assemble
 - Configure
 - Integrate
 - Test, and
 - Stage network equipment in preparation for network deployment/rollout.
- Includes
 - Development of Network Operations manuals
 - Network Maintenance manuals, and
 - Reporting of test results.

Critical Design Example



Network Operations Stage

STAGES & PHASES	NETWORK OPERATIONS STAGE			
	Network Deployment Phase			Network Opns & Maintenance Phase
MAJOR ACTIVITIES	Prepare Deployment Procedures	Install Network	Conduct DTAI Acceptance	Operate the Network
		Prepare DTAI Acceptance Proc.		Perform Maintenance
	Prepare Site(s)	- Demo - Test - Analysis - Inspect	Resolve Discrepancies	Sustain Training
			Update Documentation	
		Conduct Network Operator Training	Review Lessons Learned	
PRODUCTS	Network Deployment Procedures	Installed Network	Signed Acceptance	Activity Reports Failure Reports
	Completed Facility Certification	Acceptance Procedures	Updated Documentation	Network Modifications
		Training Certificates	Operational Network Certificate	Training Certificates
			Lessons Learned	Periodic Network Performance Report
CONTROL GATES	Deployment Readiness Rev. (DRR) 	Network Test Readiness Rev. (TRR) 	Network Acceptance Rev. (NAR) 	Periodic Network Perf. Review (NPR) 

Operations Stage

- Network Deployment: Culminate the project with an operational network that is installed, tested, documented, accepted, and turned over to the operations and maintenance organization.
 - Detailed design documentation used to install network at customers site
 - Well developed transition and back-out plans are required
 - System Requirements are the criteria for acceptance
 - SR are accepted through DTAI (demo, test, analysis, and inspection)

Network Operations

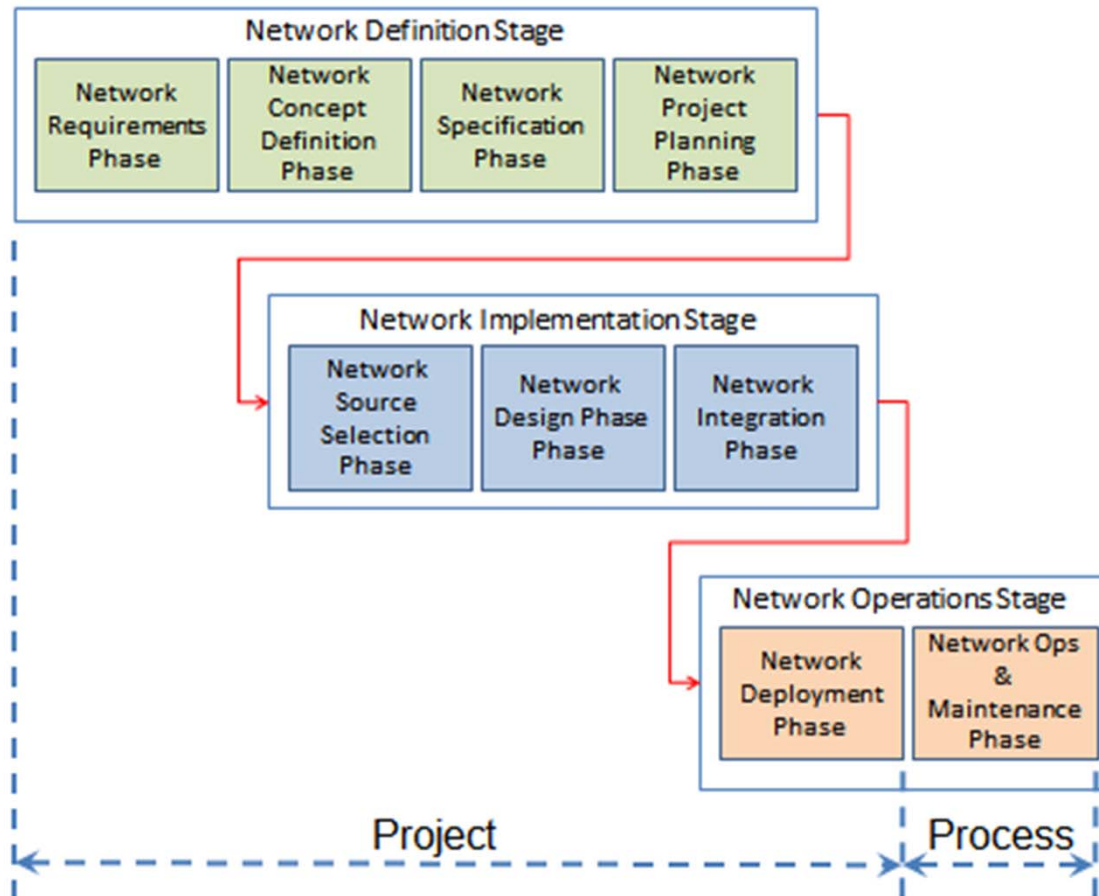

Operations Stage

- Operations & Maintenance:
 - Operate the network system for the remaining lifetime of the network
 - In a way that satisfies the ongoing mission of the enterprise or users utilizing the network.
 - The O&M organization must insure timely delivery of network functionality, performance, and uptime.
 - Fault Management
 - Performance Management
 - Security management
 - Configuration Management
 - Accounting Management
 - The network will most likely evolve through
 - O&M projects
 - Network Enhancement projects

Configuration Management

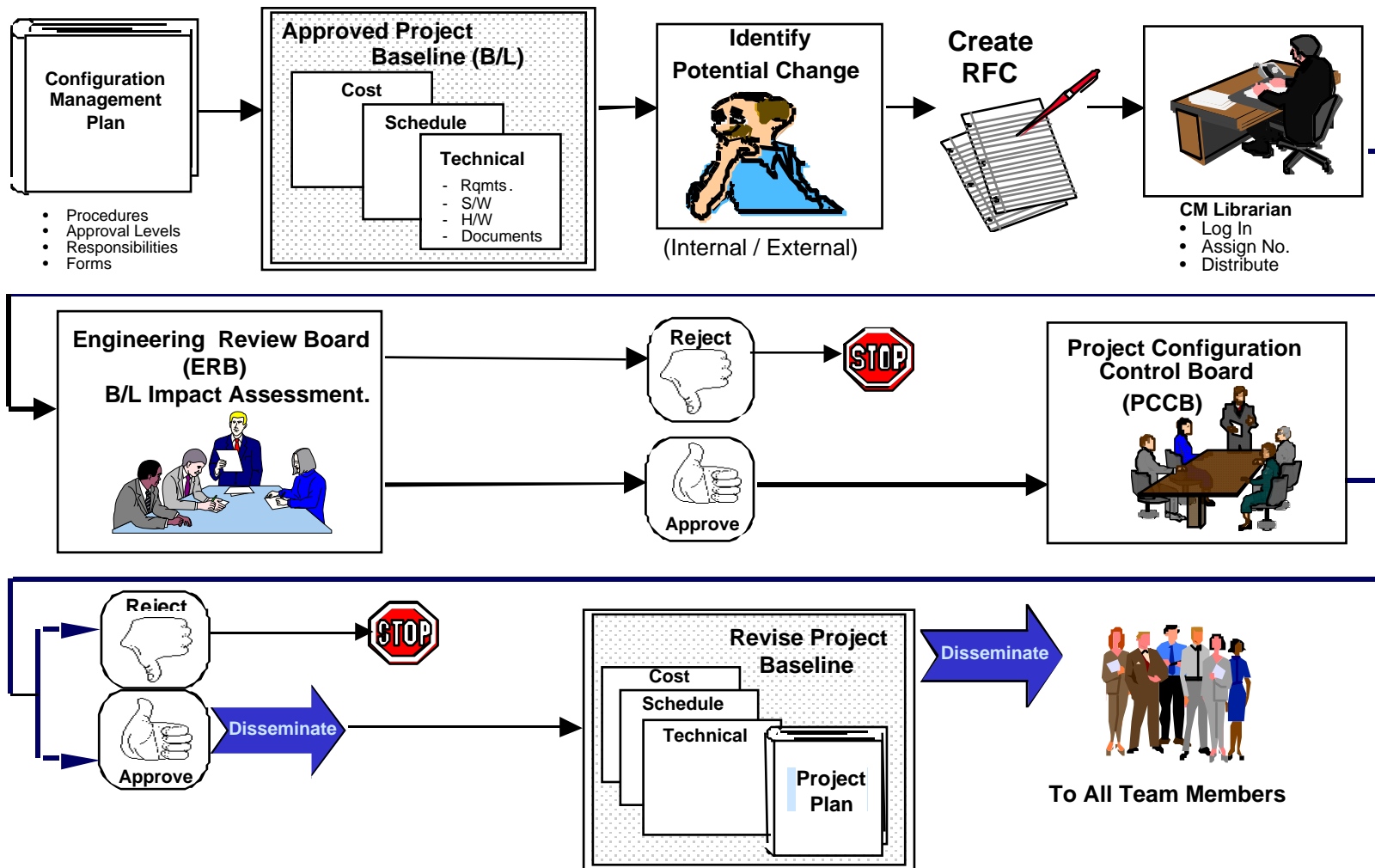

Too Much Change Can Doom a Project

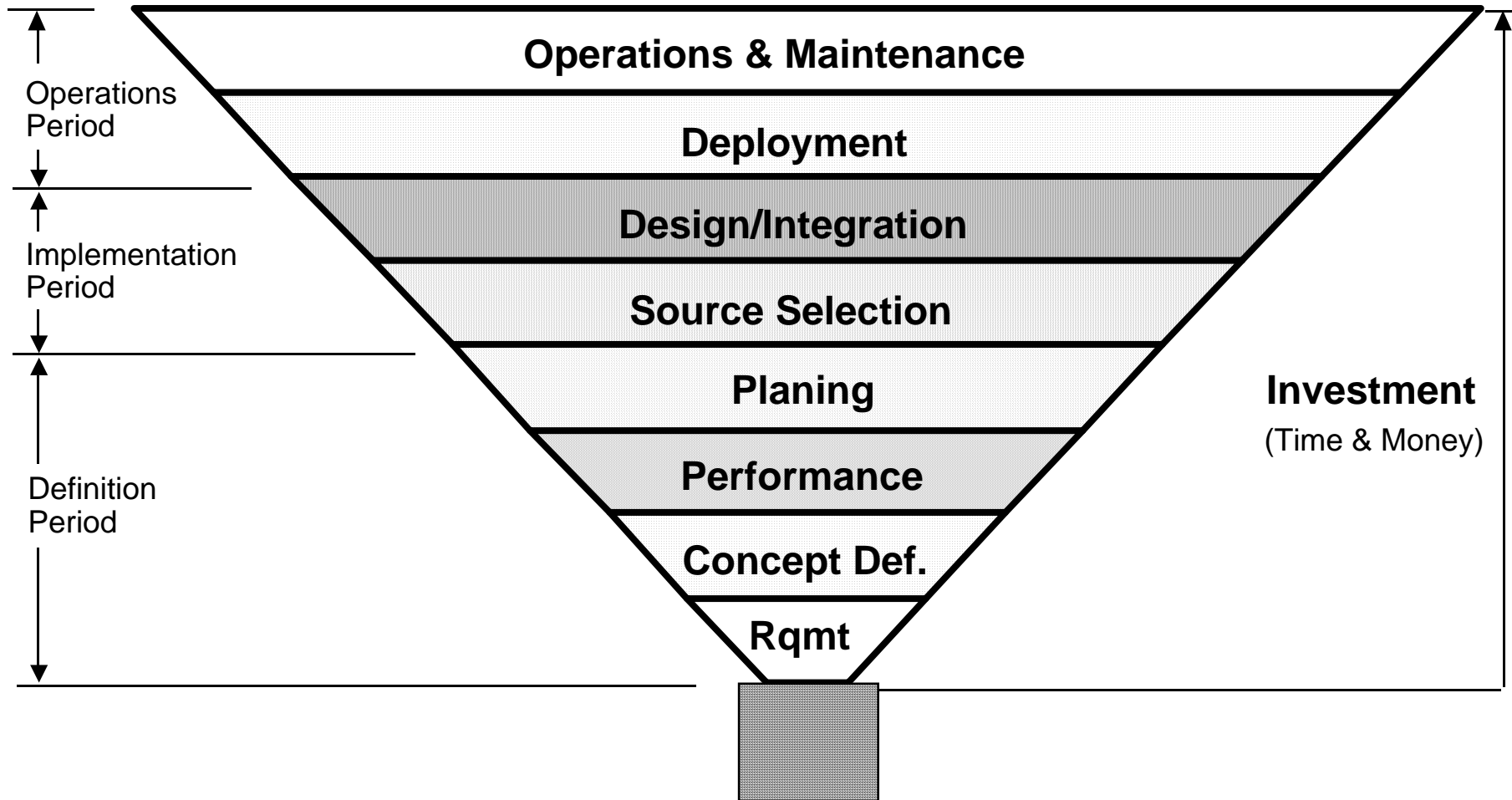

Self Assessment Q1

- You are a network analyst at Boeing. You accompany your boss, the Director of Network Services, to brief the President the Boeing Aircraft Company on the new digital services you would like to procure to support design and manufacturing. You brief the network concept and technology for the new services and then your boss proudly tells the President that this new network system will save the company \$1.2M per year. The President replies “I drop over \$2M dollars on the shop room floor everyday. So at this point, I really don’t care about your proposal or the technology. If I were to use your technology, *how many more 747s can I produce a month?*” Come back in a month with an answer and I will consider your proposal.”
 - A. I have no idea how to answer this question
 - B. I have an idea how to answer this question, and with enough time could figure it out.
 - C. I am confident I know exactly how to go about answering the question

Self Assessment Q2

- You are on a project team at a corporation considering leasing Virtual Private Network (VPN) services from a telecommunication service provider to interconnect your 55 nationwide offices. The vendor tells you the mean time between failures (MTBF) for their VPN service is 4200 hours (about once every ½ year). You share this good news with your project manager and a major internal customer, the Vice President for Sales, telling them this indicates the network rarely breaks down. The VP insists you relate this statistic to her business mission. You ask what she means and she says, “Well, for instance, if we use such a network, what’s the chance that a salesperson will be able to successfully place their weekly orders sometime during the business day on Friday’s?”
- A. I have no idea how to answer this question
 - B. I have a pretty good idea how to answer question, and with enough time could figure it out.
 - C. I am confident I know exactly how to go about answering the question

Self Assessment Q3

- A junior network consultant at Accenture is tasked to assess the network enhancement needs of a client. The consultant visits and the client's VP tells her he wants a 100Mbps backbone LAN, a firewall, and some T3 (45 Mbps) access lines to the Internet. In addition, he wants her to design this system and recommend a vendor to put in the network. Months after implementation, the VP complains to her manager that the system is not allowing his workers to be productive and is too expensive. Exasperated, the junior consultant says she gave him what he asked for, so she cannot understand why he was upset with her services. The VP replies – “Hey, I hired Accenture and paid your premium rates to do the right thing and keep me out of trouble. Now I have egg on my face – Accenture let me down.” *In retrospect, how could this situation have been prevented by the junior consultant?*
 - A. I have no idea how to answer this question
 - B. I have a pretty good idea how to answer question, and with enough time could figure it out.
 - C. I am confident I know exactly how to go about answering the question

Before & After Self Assessment

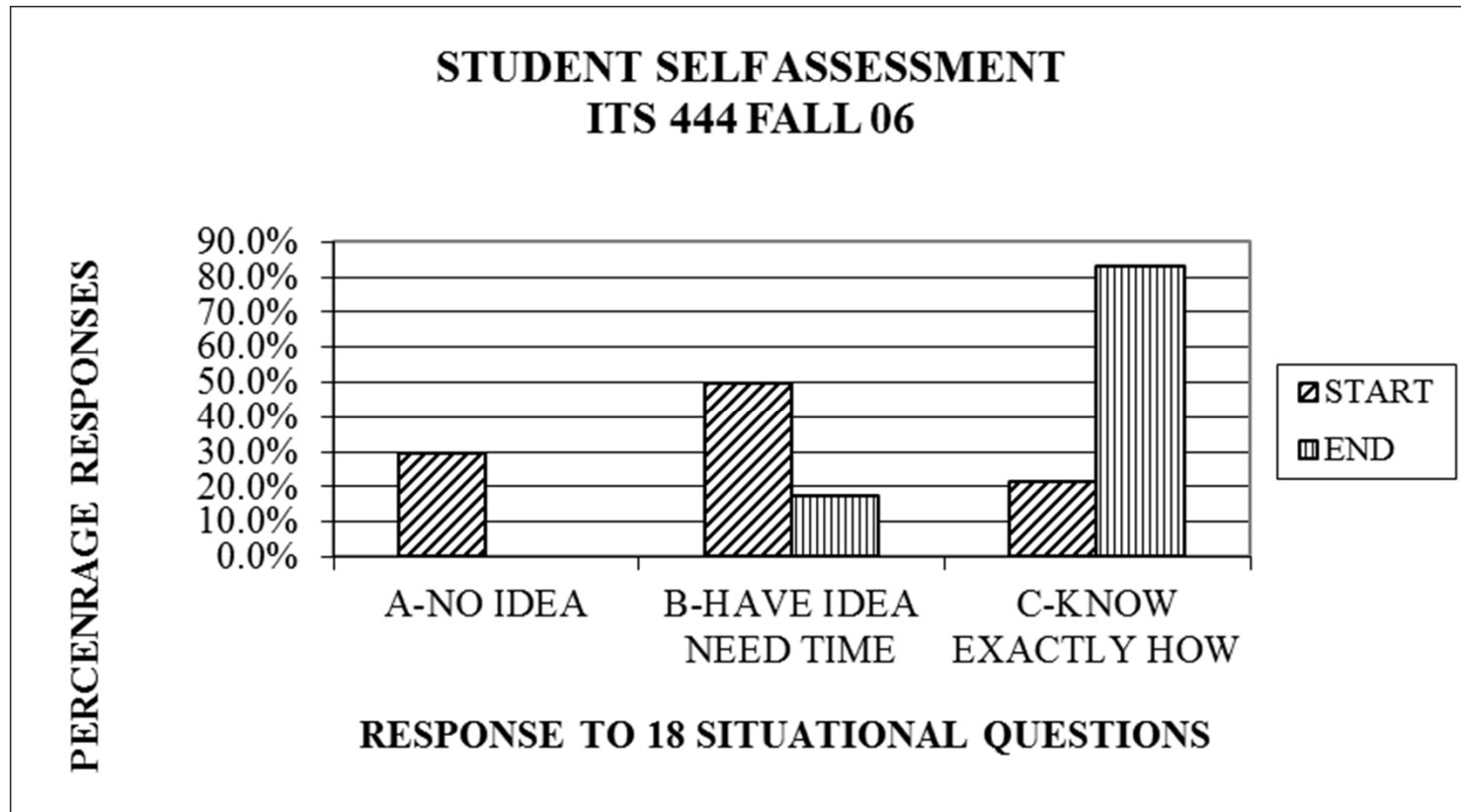

Questions?

Feedback

- Review Book
 - Write a short review?
 - Provide errata and suggestions?
- Contact me at asnow@ohio.edu